

Leica Captivate



Technical Reference Manual
Version 3.0
English

- when it has to be **right**

Leica
Geosystems

Introduction

Purchase

Congratulations on the purchase of the Leica Captivate software.

Symbols

The symbols used in this manual have the following meanings:

Type	Description
	Important paragraphs which must be adhered to in practice as they enable the product to be used in a technically correct and efficient manner.



To use the product in a permitted manner, please refer to the detailed safety directions in the available User Manuals.

The CS35 is a Windows based tablet with a Leica Image installed and Leica Captivate field software running. Changing settings in the image respectively in the operating system of the CS35, other than changes recommended by Leica Geosystems, is the responsibility of the user.

The proper operation of Leica Captivate cannot be guaranteed anymore after such changes.

Any support by Leica Geosystems after such changes is limited and lies rather in the responsibility of the user or the user's IT department.

Changes allowed	Changes that might cause issues
<ul style="list-style-type: none">Installing software	<ul style="list-style-type: none">Loading another, non Leica imageInstalling non Leica provided driversLoading software which is also using the CLM license management but working on a different version

 Bringing the CS35 into an IT infrastructure might change network settings automatically and can result in issues of the Leica network settings.

Trademarks

- Windows is a registered trademark of Microsoft Corporation in the United States and other countries
- Bluetooth® is a registered trademark of Bluetooth SIG, Inc.
- SD Logo is a trademark of SD-3C, LLC.

All other trademarks are the property of their respective owners.

Validity of this manual

- This manual applies to the Leica Captivate software.
- This manual covers all instruments using Leica Captivate software.







Video tutorials are available on:

<http://www.leica-geosystems.com/captivate-howto>

On the last page of this manual, you can find the address of Leica Geosystems headquarters. For a list of regional contacts, please visit http://leica-geosystems.com/contact-us/sales_support.

**Available documenta-
tion**

Name	Description/Format		
CS20 User Manual GS10/GS15 User Manual GS14/GS16 User Manual GS18 User Manual GS25 User Manual TS16 User Manual MS60/TS60 User Manual	All instructions required to operate the product to a basic level are contained in the User Manual. Provides an overview of the product together with technical data and safety directions.	-	✓
CS20 Quick Guide GS10/GS15 Quick Guide GS14/GS16 Quick Guide GS18 Quick Guide GS25 Quick Guide TS16 Quick Guide MS60/TS60 Quick Guide	Provides an overview of the product together with technical data and safety directions. Intended as a quick reference guide.	✓	✓

Name	Description/Format		
Leica Captivate Technical Reference Manual	Overall comprehensive guide to the product and apps. Included are detailed descriptions of special software/hardware settings and software/hardware functions intended for technical specialists.	-	✓
Licence Activation for CS35	Guide to activate the preinstalled licence on the CS35.	✓	✓

Refer to the following resources for all documentation/software:

- the Leica USB documentation card
- <https://myworld.leica-geosystems.com>

1 Leica Geosystems Software Licence Agreement

Please read this License Agreement thoroughly before using the Software

PLEASE READ THE FOLLOWING TERMS AND CONDITIONS OF THIS LICENSE AGREEMENT (THE "LICENSE AGREEMENT") CAREFULLY BEFORE USING THIS PRODUCT (AS DEFINED IN SECTION 1). THE PRODUCT INCLUDES SOFTWARE, WHICH LEICA GEOSYSTEMS WILL LICENSE TO YOU FOR USE ONLY IN THE MANNER DETAILED BELOW. YOU MUST NOT INSTALL OR USE THE SOFTWARE UNLESS YOU HAVE READ AND ACCEPTED THE TERMS AND CONDITIONS HEREIN; BY PROCEEDING WITH THE INSTALLATION OR THE USE OF THE SOFTWARE OR ANY PART THEREOF, YOU SHALL BE DEEMED TO HAVE AGREED TO ALL THE TERMS AND CONDITIONS OF THE LICENSE, THE WARRANTY, THE LIMITATION OF LIABILITY AND THE OTHER PROVISIONS OF THIS LICENSE AGREEMENT.

IN THE EVENT THAT YOU DO NOT AGREE TO THE TERMS AND CONDITIONS OF THIS LICENSE AGREEMENT, YOU SHALL NOT BE PERMITTED TO USE THE SOFTWARE, AND YOU MUST RETURN THE UNUSED SOFTWARE TOGETHER WITH ITS ACCOMPANYING DOCUMENTATION AND THE PURCHASE RECEIPT TO THE DEALER FROM WHOM YOU PURCHASED THE PRODUCT WITHIN TEN (10) DAYS OF PURCHASE TO OBTAIN A FULL REFUND OF THE PURCHASE PRICE.

THIS SOFTWARE MAY INCLUDE PRODUCT ACTIVATION AND OTHER TECHNOLOGY DESIGNED TO PREVENT UNAUTHORIZED USE AND COPYING OR TO PROVIDE TECHNICAL OR SUPPORT SERVICES REMOTELY BY LEICA GEOSYSTEMS OR ITS AUTHORIZED RESELLER. THIS TECHNOLOGY MAY CAUSE YOUR COMPUTER OR DEVICE TO AUTOMATICALLY CONNECT TO THE INTERNET. ADDITIONALLY, ONCE CONNECTED, THE SOFTWARE MAY TRANSMIT YOUR SERIAL NUMBER/LICENSE NUMBER TO LEICA GEOSYSTEMS AND IN DOING SO MAY PREVENT USES OF THE SOFTWARE WHICH ARE NOT PERMITTED; ALSO, THE SOFTWARE MAY TRANSMIT OTHER SUPPORT-RELATED INFORMATION, SUCH AS CONFIGURATIONS, USAGE STATISTICS, OR ALLOW OR PUSH DOWNLOADS OF UPDATES TO PRODUCT SOFTWARE.

1 Definitions

"Patches" shall mean the fixing of a programming error (bug) or a wrong behaviour of the software or the related software code.

"Product" shall mean (a) the Leica Geosystems instrument you have purchased for use with the Software, if any, or (b) the Software itself, if you have purchased the Software on a stand-alone basis.

"Purchase Agreement" shall mean the purchase order, agreement or other document pursuant to which you purchased the Product.

"Software" shall, depending on the case, mean the Leica Geosystems software and the related documentation (in electronic or in paper form) (a) that is supplied to you on a data carrier medium, or (b) that is pre-installed on the Product (if the Product is not the Software itself), or (c) that can be downloaded by you online pursuant to prior authorization from Leica Geosystems.

"Specifications" shall mean the functionality of the Software as described in the Product description and the help functions, if any, provided in electronic or in paper form by Leica Geosystems in conjunction with the Software.

"Specified Computer Facility" shall mean the computer or server environment defined in the Product description that is required for the proper functioning of the Software.

"Updates" shall mean software that correct faults in the Software or that, pursuant to no obligation hereunder, enhances the functionality of the Software by providing additional functions or any other increases in performance.

2 Scope of the License

Leica Geosystems AG, Heinrich-Wild-Strasse, CH-9435 Heerbrugg, Switzerland (alternatively, the "Licensor" or "Leica Geosystems") hereby grants to you (the "Licensee") subject to payment of the applicable license fee and to continuous compliance with all the provisions hereinafter, the **non-exclusive, non-transferable, non-sublicenseable and non-assignable right, to use in the manner set forth herein** the Software on one (1) application, unless otherwise agreed upon in the Purchase Agreement. The use of the Software for a purpose other than as licensed herein shall not be permitted.

The foregoing license is **limited as follows**: (a) the Software will only be used on such permitted number of applications and in a mechanically readable form; (b) the Software will as a whole or in part be installed, saved and run only on the Specified Computer Facility in accordance with the installation instructions of Licensor; and (c) one (1) copy of the Software may be made exclusively for security and archiving purposes, provided that such copy carries a comprehensive copyright notice together with all additional references to the rights of Licensor to the Software and the designation of the original version. In the event that the Software is an update or an additional module for an already licensed system, instrument or facility, Licensee may make only as many copies as previously authorized by Licensor. Certain Software supplied by Licensor may contain a special program that regulates and monitors the number of simultaneous users of the Software in a network environment together with the number of the licensed copies of the Software, excluding back-up copies (the "Special Program"). Licensee hereby consents to the inclusion and operation of such Special Program and to the use of other security devices in connection with the Software and Licensee shall be prohibited from circumventing, reverse-engineering or copying such Special Program or any other security devices.

Licensee will only use the Software in the manner permitted under the foregoing license and will not (a) alter the Software or any part thereof in any manner (including, without limitation, through modifications, adaptations, translations, or second-hand versions.), (b) decompile the Software or any part thereof, (c) reverse-engineer or disassemble the Software or any part thereof or manipulate the Software in any other way into a form that persons can read, (d) transfer the Software or any part thereof to another operating system, (e) pass on the Software or any part thereof to a third party or make it available to a third party in any other manner (including, without limitation, for testing or by gift, lease, loan or sublicense, or via a service bureau) without the prior written consent of Licensor, (f) use the Software or any part thereof on a computer facility other than the Specified Computer Facility, or on more than one work station, on networks, on a client server system or on mobile additional instruments without the prior written consent of Licensor, (g) remove, alter, or obscure any proprietary notices, labels, or marks from the Software, (h) use any equipment, device, software, or other means designed to circumvent or remove any form of copy protection used by Leica Geosystems in connection with the Software, or use the Software together with any authorization code, serial number, or other copy-protection device not supplied by Leica Geo-

systems directly or through an authorized distributor; or (i) use any equipment, device, software, or other means designed to circumvent or remove any usage restrictions, or to enable functionality disabled by Leica Geosystems.

Installation, access, and continued use of the Software may require an entitlement number. Registration may be required for certain features or before an entitlement number is issued by Leica Geosystems. Licensee agrees that Leica Geosystems may use data and information provided by Licensee, an authorized reseller, or any other third party acting on behalf of Licensee in connection with the purchase of the software license to register the Software. Licensee agrees to provide Leica Geosystems, an authorized reseller, or any other third party acting on Licensee's behalf with accurate and current registration information, and Licensee further agrees to maintain and update this registration information through customer data registration processes that may be provided by Leica Geosystems. By installing and using the Software, Licensee consents to Leica Geosystems using any personal information provided at registration, or updated thereafter, to issue entitlement numbers, to manage Leica Geosystems's relationship with Licensee (including automating the issuance of entitlement numbers for future purchases), and to otherwise use any such personal information in conformance with its privacy policy –if applicable-, which is available on request.

The activation security mechanisms may disable the Software if Licensee attempts without Leica Geosystems' consent or authorisation to transfer it to another computer or device, if the date-setting mechanisms on the computer or device is tampered with, if Licensee uses the Software past an applicable evaluation period or limited term, or if Licensee undertakes certain other actions that may offset the security mode.

This Software may cause the Specified Computer Facility to automatically connect to the Internet and to communicate with Leica Geosystems and or with third parties connected with the development and/or the validation of the Software.

This Software license does not cover or include the use of **third party software**. Licensee's right to use any such software shall be governed by the provisions set forth by such third party.

This Software license shall also apply to **Open Source Software (OSS)**. In case of conflict with the terms of this Software License Agreement, the terms of the respective OSS license agreement shall govern.

3 Warranty

Express Warranty. Licensor warrants to the original Licensee that (a) the **data carrier medium** on which the Software is stored shall be free from defects in workmanship and material at the time of delivery to Licensee, and (b) for the warranty period specified in the relevant Purchase Order, the Software (but not Updates) shall function in material accordance with the Specifications, provided the Software is used in the manner permitted in the foregoing license, on the Specified Computer Facility and in accordance with the conditions of installation, use and operation set forth in the Product description.

Licensor does not warrant that the Software will be free of defects, run without interruption, meet the expectations of Licensee, or function in combination with the hardware or software products of third parties, or that all program errors will be corrected. In addition to the foregoing, in order for a defect in the Software to be sufficiently material so as to violate the warranty set forth in letter (b) above of this paragraph, the defect must cause the Software - while being used in the manner permitted in the foregoing license - to func-

tion in a way so divergent from the Specifications that it is unsuitable for the purpose described in the Product description. Furthermore, if the required functionality can be achieved by the Licensee indirectly (through a so called "work-around"), then the applicable impairment shall not constitute a defect giving rise to duties under the foregoing warranty. **Licensors sole obligation** under the foregoing warranty shall be, at Licensor's sole option and expense, to either (a) **replace** the data carrier and/or the Software, so as to materially conform with the Specifications (including, without limitation, replacement with a more recent version or equivalent software); or (b) **repair** the Software by providing, correction codes, work-around solutions and/or Updates, including updated documentation and other documents; or (c) **terminate** this License Agreement and refund all license fees received following the return of the Software in accordance with Section 7 below. The foregoing warranty will apply to any replaced data carriers and Software until expiry of the original warranty period. The costs and risk of any delivery of Software to the service point nominated by Licensor shall be borne by Licensee.

Obtaining warranty service. If Licensee detects a defect in the Software that may give rise to a duty under the foregoing warranty, it will cease using the Software immediately and notify Licensor or its local sales partner in writing of the defect and provide sufficient supporting documentation within the period for notifying defects. Such period for notifying defects is ninety (90) days from the date of delivery of the data carrier medium (for a defect in the data carrier medium) and one (1) year from the date of delivery of the Software (for a defect in the Software). The written supporting documentation relating to the defect will be sufficient if it permits the defect detected by Licensee to be capable of reproduction by Licensor. Licensee will annex the relevant purchase receipt so that Licensor can determine compliance with the periods for notifying defects. Licensee will not carry out modifications or repairs itself or permit such modifications or repairs to be carried out by unauthorized third parties. If requested by Licensor, Licensee will support Licensor in the analysis of the causes and conditions giving rise to the defect, as well as in the development and testing of correction codes or a work-around solution.

Warranty exclusive. Licensee's sole remedy for Software defects is set forth in the foregoing express warranty. The Software is licensed with its current features "as is" and with no warranty or guarantee of whatever nature, other than the foregoing express warranty. Such express warranty is in lieu of all other warranties, express or implied, either in fact or by operation of law, statutory or otherwise, including warranties, terms or conditions of merchantability, fitness for a particular purpose, satisfactory quality and non-infringement, all of which are expressly disclaimed. Licensee acknowledges that Licensor's sales partner or dealers are not allowed to provide any warranty, guarantee or assurance with regard to the use, suitability, or results of use of the Software, or with regard to the precision, accuracy or reliability thereof, and any such warranty, guarantee or assurance is of no effect. It shall be the responsibility of Licensee to select the Software that fulfils its requirements. Licensee shall bear the full risk for the performance of and results achieved by the Software and for its suitability for the use that Licensee has planned for it, even when Licensor has been informed of the planned use of the Software.

Licensor shall be relieved of its obligations under the foregoing express warranty to the extent that any defect is caused by circumstances for which it is not responsible, including, without limitation, (a) non-compliance with the conditions of use and operation contained in the Product description or the documentation; (b) non-compliance with the provisions of this License Agreement; (c) unauthorized modifications to or interference with the Software by Licensee or third parties; (d) errors in the operation of the Software by Licen-

see or by third party staff; (e) influences from systems or programs that have not been supplied by Licensor; or (f) use on a computer facility other than the Specified Computer Facility.

In the event that Licensor is not responsible for a defect pursuant to these warranty provisions or that Licensor incurs additional expenditure as a result of the failure of Licensee to comply fully with its obligations under this Section 3 (including, without limitation, its obligation to support and provide documentation to Licensor), Licensor shall have the right to charge Licensee for the costs that it incurs for the analysis and rectification of the defect according to the time and materials required and in accordance with the applicable rates charged by Licensor at the time.

4 Intellectual Property Rights

Licensee shall only hold those rights to the Software that are expressly described in Section 2 of this License Agreement. Any other rights with regard to the Software, including without limitation, **ownership rights and patent, copyright, trademark, trade secret and other intellectual property rights**, shall remain the sole **property of Licensor**. Licensee will not remove from the Software any references to copyrights, trademarks or other ownership rights, or cover up or alter any such references. Licensee will take all reasonable steps to prevent any unauthorized use, reproduction, sale, or publication of the Software or the unauthorized provision of access thereto. Licensee will indemnify and hold harmless Licensor from any losses, damages, claims and expenses (including, without limitation, reasonable legal expenses) relating to any infringement of the rights of Licensor caused by Licensee, Licensee's breach of this License Agreement or Licensee's use of the Software in a manner not authorized under this license agreement.

In the event that Licensee faces legal proceedings based on the allegation that Licensee's use of a valid, unmodified version of the Software in accordance with the terms and conditions of this License Agreement infringes an existing intellectual property right in Switzerland, the European Union, Japan, the USA or in any other countries where Licensor sells the Software, or that such use constitutes unfair competition, Licensor shall defend any such proceedings at its own expense, provided that Licensee has informed Licensor immediately in writing of the proceedings raised, has granted Licensor a Power of Attorney authorizing it to conduct and settle the legal proceedings, and, if requested by Licensor, has provided Licensor with reasonable support in the defence of such proceedings.

In the event that, in the sole opinion of Licensor, the **valid, unmodified version of the Software could infringe the intellectual property rights of third parties**, it shall at its own exclusive discretion (a) either obtain authorization from such third party for the continued use of the Software by Licensee, (b) replace the Software, (c) modify it in such a manner that there is no longer any infringement of intellectual property rights, or (d) if the foregoing measures are not within the bounds of what is reasonably possible, terminate this Agreement effective immediately and refund to Licensee a portion of the license fees paid (after deduction of an appropriate payment for the use already made of the Software by Licensee).

Notwithstanding the foregoing, Licensor shall be relieved of its obligations under the prior two paragraphs of this Section 4 if the infringement claim is based on the allegation or fact that the Software (a) has been modified by Licensee, or (b) is being used with other programs or data and such combination has led to an infringement of a third party right, (c) has been used on a computer facility other than the Specified Computer Facility, or (d) has been

used and operated under conditions other than those specified in the Product description.

5 Limitation of Liability

To the extent permitted under applicable law, Licensor shall not be liable for any direct, indirect or consequential loss or damage, including, without limitation, loss of income, loss of business profits or loss of contracts, unrealized cost reductions, loss of data, business interruption, or increased costs on the part of Licensee or any other financial losses, that result from or in connection with the purchase, license, use, breakdown or interruption of operation of the Software. The foregoing limitation of liability shall also apply in the event that Licensor has been notified of the possibility of such losses being incurred. Licensor shall only be liable for loss or damage caused by Licensor's gross negligence or wilful misconduct. This limitation of liability shall apply to all claims for loss and damage irrespective of their legal grounds, including, without limitation, claims based on tort, contract, pre-contract or quasi-contract. This limitation of liability shall also apply to any officers, directors or employees of Licensor, or any representatives or agents of Licensor that are involved in the development, marketing or supply of the Software.

It shall be the exclusive duty of Licensee to ensure that it and its staff possesses the required knowledge to properly install and use the Software. Licensor shall not be liable for problems and defects that arise from insufficient knowledge on the part of the users of the Software.

6 Exclusion of other Assurances

Licensee hereby agrees that no verbal or written assurances, declarations, statements, recommendations or advertising messages have been made by Licensor, its employees, sales partners, agents, dealers or downstream distributors that could give rise to an amendment or extension of the foregoing warranties and limitation of liability. Licensee is hereby given notice that none of the forenamed persons is authorized by Licensor to make any such amendments or to provide any such assurances.

7 Duration and Termination

This License Agreement shall come into force on the agreement of Licensee to the provisions hereof and shall remain in force for the term indicated in the Purchase Order.

In addition to any other right of termination provided in this License Agreement, each party shall be entitled to terminate this License Agreement at any time with immediate effect:

- a) in the event of a material violation of a contractual duty by the other party, including, without limitation, default in payment of the license fee, if the party in breach does not remedy such violation within forty-five (45) days after being served with a notice in writing;
- b) is unable to pay its debts, or becomes insolvent, or is subject to an order or a resolution for its liquidation, administration, winding-up or dissolution (otherwise than for the purposes of a solvent amalgamation or reconstruction), or has an administrative or other receiver, manager, trustee, liquidator, administrator or similar officer appointed over all or any substantial part of its assets, or enters into or proposes any composition or arrangement with its creditors generally, or is subject to any analogous event or proceeding in any applicable jurisdiction.

On any termination of this License Agreement, all rights of use of the Software held by Licensee shall expire. Within thirty (30) days from the date of termination of the License Agreement Licensee will return to Licensor or destroy (and confirm such destruction in writing to Licensor) the Software and all copies or partial copies thereof that have been made, as well as all modified parts of the Software or interfacing parts linking to other programs or data systems, and to the extent available, all security devices.

8 Import, Export and Use of the Software

Licensee shall be exclusively responsible for ensuring compliance with the relevant legislation relating to its rights to import, export or use the Software.

9 General Provisions

If any term or provision of this agreement shall be or shall become invalid or unenforceable for any reason, such term or provision shall be ineffective to the extent of such invalidity or unenforceability without invalidating the remaining terms and provisions hereof, provided, however, that the parties shall replace any such invalid or unenforceable provision by a valid and enforceable provision as comes nearest to the original provision in economic impact and intent. This agreement may only be modified in writing, signed by an authorized officer of Leica Geosystems. This is the entire agreement between Leica Geosystems and Licensee regarding the Software and it supersedes any prior representation, discussions, undertakings, communications or advertising relating to the Software.

10 Third Party Beneficiary

The parties expressly agree that subsidiaries of Leica Geosystems, including the entity from whom the Customer purchased the Product, is a third party beneficiary of this Software License Agreement, and, without limiting the foregoing, such subsidiaries shall have all defences available to Leica Geosystems under this Software License Agreement.

11 Governing Law and Place of Jurisdiction

This Agreement shall be governed by the laws of Switzerland, excluding all conflicts of laws principles and excluding the United Nations Convention on Contracts for the International Sale of Goods. The ordinary courts at the headquarters of Leica Geosystems AG in Balgach, Switzerland shall have jurisdiction. Licensor shall, in its sole discretion, also have the right to invoke the courts of law having jurisdiction at the domicile or place of business of Licensee.

Leica Geosystems AG
Heinrich-Wild-Strasse 201
CH - 9435 Heerbrugg
(Switzerland)

Heerbrugg, 25 March 2013

2

Operating Principles

2.1

Software

Keyboard and Touch Screen

The user interface is operated either by the keyboard or by the touch screen with supplied stylus. The workflow is the same for keyboard and touch screen entry, the only difference lies in the way information is selected and entered.

Operation by keyboard

Information is selected and entered using the keys.

Operation by touch screen

Information is selected and entered on the screen using the supplied stylus.

Operation	Description
To select an item	Tap on the item.
To start the edit mode in editable fields	Tap on the editable field.
To highlight an item or parts of it for editing	Drag the supplied stylus from the left to the right.
To accept data entered into an editable field and exit the edit mode	Tap on the screen outside of the editable field.
To open a context-sensitive menu	Tap on the item and hold for 2 s.

Searching

Searching is possible in panels with and without pages.

1. Open a panel or page with listed items.



2. Type in any letter or number key to start the search.



On the TS, the setting for **Data input method** in **Screen, Audio & Text Input** defines how characters can be typed. Refer to "28.2 Screen, audio & text input".



A search field appears below the icons in the top right area of the panel. The field shows the characters typed in.





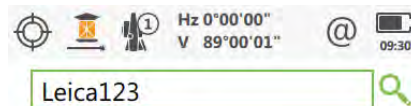









The job search is not case sensitive.



3. The item with the name closest to the letters typed in is highlighted.

Functions of key when job search is active in the Leica Captivate - Home menu

Key		Function
Function keys F1-F6		Press Esc first to leave the job search.  Correspond to six softkeys that appear on the bottom of the screen when the screen is activated.
Function keys F7-F12		Press Esc first to leave the job search.  User definable keys to execute chosen commands or access chosen screens.
Alphanumeric keys	4 GHI 	To type letters and numbers.
Esc		Leaves the job search.
Fn	 	Press Esc first to leave the job search. Switches between the first and second level of function keys.
Enter		Leaves the job search.
ON/OFF		Turns to Power Options menu when held for 2 s.
Favourites		Without function. The search field remains in edit mode.
Home		Leaves the job search.
OK		Leaves the job search.

Functions of icons when job search is active in the Leica Captivate - Home menu

Icon		Function
Magnifying glass		Leaves the job search.

Functions in job and apps carousel when job search is active in the Leica Captivate - Home menu

Action	Function
Tapping on any job that is not in the centre of the job carousel	Leaves the job search. Moves the tapped job to the centre of the carousel.



Action	Function
Tapping on any job that is in the centre of the job carousel	Leaves the job search. Opens the job menu for that job.
Tapping on any app in apps carousel	Leaves the job search.  Tap again on the app icon to start the app.

2.2 Configurable Keys

2.2.1 Hot Keys

Description	Two levels of hot keys exist: <ul style="list-style-type: none"> The first level is the keys F7 to F12 and F13, the key on the side of the instrument. The second level is the combination of Fn and F7 to F12.
Functionality	Hot keys provide a shortcut for quickly and directly carrying out functions assigned to the keys. The assignment of functions to hot keys is user configurable.
Use	<ul style="list-style-type: none"> The first level is accessed by pressing F7 ... F12 or F13 directly. The second level is accessed by pressing Fn first followed by F7 ... F12. Hot keys can be pressed at any time. It is possible that a function assigned to a hot key cannot be used in certain situations.
Define hot key step-by-step	<p>This step-by-step description shows how to assign the Regional panel to the F7 key.</p> <ol style="list-style-type: none"> Select Leica Captivate - Home: Settings\Customisation\Hot keys & favourites. Hot Keys & Favourites Select F7: User - Regional settings on the TS hot keys page. OK OK Press F7 to access Regional.
Key on the side of the instrument	The key on the side of the instrument is located next to the right-hand fine drives. It enables fast and comfortable recording of measurements. Being equipped with a soft touch key located on the instrument's turning axis allows highest precision measurements. All functions that can be assigned to the hot keys can be assigned to this key including <None> .

2.2.2 Favourites Key

Description	<p>For GS:</p> <ul style="list-style-type: none"> The  key opens the My GS Favourites menu. <p>For TS:</p> <ul style="list-style-type: none"> The  key opens the My TS Favourites menu.
--------------------	---

Functionality of the favourites menu

The **My GS Favourites** and **My TS Favourites** menus can be configured to contain the most used functions. The favourites menu cannot be accessed while in a settings panel.

Selecting an option in the menu carries out the function assigned to the option.

My favourites menu

The following panel is an example of what a **My GS Favourites** or **My TS Favourites** menu can look like. The functions which are assigned to the individual places in the menu can differ depending on the settings.

Tap on a pop-up bubble menu item to use a function.

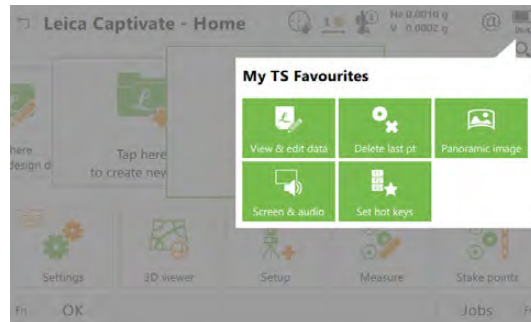

Define favourites menu step-by-step

Defining the favourites menu is the same process as for defining the hot keys. Refer to "2.2.1 Hot Keys".

3

Home



3.1

Functions

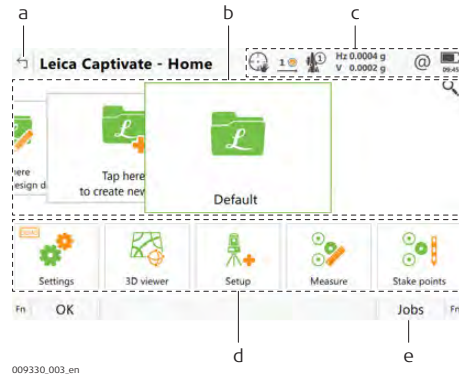
Leica Captivate - Home



- a Quit
- b Job carousel
- c Icon bar
- d Apps carousel
- e Keys

Key	Description
OK	To open and close the job menu.
Jobs	To access the Job Management panel. Refer to "3.3 Job Management".
Fn Instrument	To switch between GS and TS mode.
Fn New job	To create a new job.
Fn Exit	To close software.
Icon	Description
	Displayed in the bottom right corner of the job tile. When the icon is displayed, then the job is stored to the SD card. When no icon is displayed, then the job is stored to the internal memory.
	Software maintenance is close to due date or has expired. The reminder message has previously been confirmed with OK . The icon will disappear when licence keys are entered manually or uploaded from a file. Refer to "29.3 Load licence keys".
	Displayed in the bottom right corner of the Settings tile. When the icon is displayed, a new Leica Captivate version is available in myWorld. For an automatic check, the instrument must be connected to the Internet. When no icon is displayed, there is no new version or the instrument is not connected to the Internet.

Description of the functions

Function	Description
Icon bar	<ul style="list-style-type: none"> • For status information and frequently used functionality.

Function	Description
Job menu	<ul style="list-style-type: none"> The selected job is displayed in the front. Tap to select an existing job. Typing one or several letters of a job name moves the job with the most similar name to the centre of the carousel. If no job name starts with the typed letters, the active job stays active. Select the left or right most tile in the carousel: Press Fn. Then press Home or End. Tap to create a job.
Job carousel	<ul style="list-style-type: none"> To manage jobs and data, import and export data, send data and delete jobs. Job menu items are shown on the second level of each job. Click a job to see the menu items. To delete a job, move the job in the centre of the job carousel. Press the  key on the keyboard.
Apps carousel	<p>Settings</p> <ul style="list-style-type: none"> To access settings regarding the instrument, instrument connections, the software and the display as well as other useful tools. <p>Apps</p> <ul style="list-style-type: none"> Contains all loaded apps. To select and start an app. Selecting an option in the menu starts the app. Settings and measurements that can be performed depend on the app.

3.2

Job Menu

Description

The job menu is available when operating an RTK rover or a TS. It is used to:

- View and edit job properties.
- View & edit data.
- Import data.
- Export and copy data.
- Start Leica Exchange.
- Delete a job.

Job menu

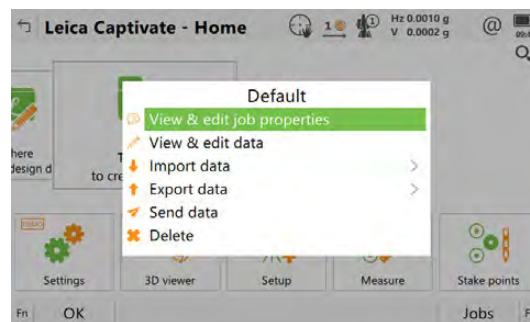

Next step

View & edit job properties

Refer to chapter "6 Job Menu - Jobs".

View & edit data

Refer to chapter "7 Job Menu - View & edit data".

Import data

Refer to chapter "10 Job Menu - Import data".

Export data

Refer to chapter "11 Job Menu - Export data".

Send data

To start an online service that allows the data exchange between two users of the service.

Delete

To delete the current job.



To delete a job, move the job in the centre of the job carousel. Press the



key on the keyboard.

3.3

Job Management

Job Management

Listed are the existing jobs on the data storage devices.



Key	Description
OK	To accept the settings and to return to the previous panel.
New	To create a new job.
Edit	To edit the highlighted job.
Delete	To delete the highlighted job.
Data	To view, edit and delete points, lines, images and scans stored with the job. Points, lines, images and scans are shown on separate pages. Selected sort and filter settings apply.
All	To set all jobs in the job carousel visible or invisible.

Description of symbols

The symbols match the setting for **Display in job carousel** in **Job properties, General** page. Refer to "6.4 Editing a Job".

Symbol	Description
	The job is visible in the job carousel.

Symbol	Description
	The job is invisible in the job carousel.

3.4

Settings

Description

Settings is used to:

- Configure parameters related to the interfaces.
- Configure parameters related to the instrument.
- Configure user favourite settings for the survey and the instrument.
- Configure parameters which are not directly related to surveying data, such as loading firmware or licence keys and format data storage devices.

Settings

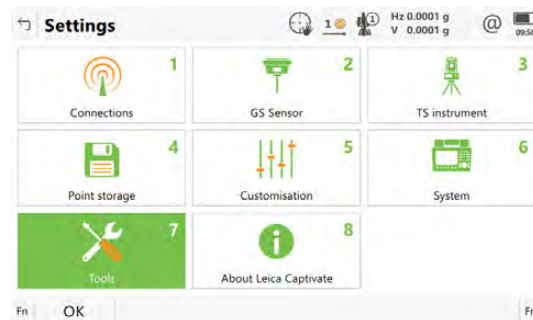

Key	Description
OK	To select the highlighted option and to continue with the subsequent panel.
Fn Instrument	To switch between GS and TS mode.

Next step

Connections

Refer to chapter "18 Connections - All other connections".

TS instrument

Refer to chapter "22 Settings - TS instrument".

GS Sensor

Refer to chapter "23 Settings - GS Sensor".

Point storage

Refer to chapter "25 Settings - Point storage".

Customisation

Refer to chapter "26 Settings - Customisation".

System

Refer to "28 Settings - System".

Tools

Refer to chapter "29 Settings - Tools".

About Leica Captivate

Refer to "30 Settings - About Leica Captivate".

4

Icons

Description

The panel icons display the status information of the instrument.



The icons provide information related to basic instrument functions. The icons that appear depend upon which instrument is used and the current instrument configuration.

Icon bar - TS Mode

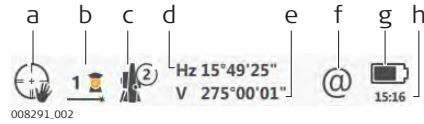

- a Aim & Search
- b Measure & Target
- c Instrument
- d Current horizontal angle of instrument, tap to see the target height
- e Current vertical angle of instrument, tap to see the slope distance
- f Connections
- g Battery
- h Time

Icon bar - GNSS Mode

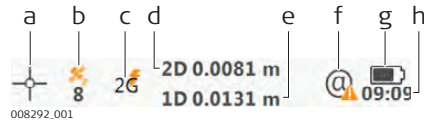







- a GS Position
- b Satellite Tracking
- c RTK Data Link
- d 2D position quality, tap to see the antenna height
- e 1D position quality, tap to see the 3D position quality
- f Connections
- g Battery
- h Time

Aim & Search



Displays the current automatic aiming or PowerSearch settings.







Icon	Description
	The instrument is in auto aiming mode using automatic aiming.
	The instrument is in manual aiming mode
	The instrument is in target lock mode, however not currently following a prism. Lock Status: Unlocked.







Icon	Description
	The instrument is in target lock mode, currently following a prism. Lock Status: Locked.
	The instrument is in prediction or locking on the fly is activated. The instrument locks toward a prism coming into the field of view and follows this prism.
	Searching for the prism using Auto aiming .
	Searching for the prism using PowerSearch .
 	Caution. Connection between CS and TS is not established.

Measure & Target

Displays the selected measurement mode.
 Displays the selected prism.
 The laser icon is displayed when the red laser is active.

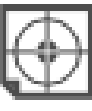

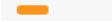
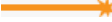

Icon	Description
	Measure distance: Once
	Measure distance: Once & fast
	Measure distance: Continuously

Icon	Description
	Measure distance: Repeatedly & average
	Measure distance: Greater than 4km
	Measure distance: >4km & average
	Measure distance: Highest precision on TS60
	Leica round prism
	Leica 360° prism
	Leica mini prism
	Leica mini 0

Icon	Description
	Leica mini 360°
	Leica Machine Automation power prism MPR122
	Leica reflective tape or HDS target.
	Any surface
	User-defined prism
	Distance measurement active
	Red laser is turned on
	Red laser is turned off







Level status



Displays the compensator is off or out of range icons, or the instrument face I or II icon.

Icon	Description
	Compensator is turned off.
	Compensator is turned on, but is out of range.
	The current face of the instrument is shown, if the compensator and the horizontal correction are turned on.
	

GS Position

Displays the status of the current position. As soon as this icon becomes visible the instrument is in a stage where practical operation can commence.

Icon	Description
	Navigation position available
	Navigation position available Tilt compensation active When the tilt pole initialisation is lost, move the pole naturally for a new initialisation.
	Code solution available
	Code solution available Tilt compensation active When the tilt pole initialisation is lost, move the pole naturally for a new initialisation.
	Fixed position available
	Fixed position available Tilt compensation active When the tilt pole initialisation is lost, move the pole naturally for a new initialisation.

Icon	Description
	xRTK fixed position available
	xRTK fixed position available Tilt compensation active When the tilt pole initialisation is lost, move the pole naturally for a new initialisation.
	The checks indicate that an ambiguity check is being made.









Satellite Tracking

Displays the number of theoretically visible satellites above the configured cut-off angle according to the current almanac.

Icon	Description
	The number of visible satellites.









RTK Data Link

Displays the status of the real-time device configured to be used.

Icon	Description
	An arrow pointing down indicates a real-time rover. The arrow flashes when real-time messages are received.
	An arrow pointing up indicates a real-time base. The arrow flashes when real-time messages are sent.
	Sending/receiving data
	Signal strength Displayed if the device being used for the RTK rover interface is the internal CS20 modem.
	RTK using Internet
	Phone
	Radio
	RS232

Icon	Description
	SBAS





Connections

Icon	Description
	Instrument is online in the Internet.
	Internet not connected.
	
	Logged in to Leica Exchange.
	Data upload in progress.
	Data download in progress.
	Exchanging new data.
	Data transfer problem.
	Active Assist is active. Leica technical support can gain remote access to the instrument.

Battery

Displays the battery level.

Icon	Description
	Sufficient power available.

Icon	Description
	Power level is getting low.
	Power level is getting very low.
	Battery empty. Instrument turns off immediately.
	

5 Icon Pop-up Bubbles

5.1 Access

Description

Status information helps using the instrument by showing the state of many instrument functions. All fields are display only fields. Unavailable information is indicated by -----.

Frequently used functionality can be accessed and changed quickly. The change is applied immediately. The workflow is not interrupted.

Changes are stored in the active working style.

Access

Tap an icon in the icon area. An icon pop-up bubble opens.

An icon pop-up bubble shows:

- Status information
- Functionality related to the icon which was tapped

Tap a bubble icon to use the functionality.

To close an icon pop-up bubble:

- Press any key on the keypad.
- Touch the panel anywhere outside of the icon pop-up bubble.

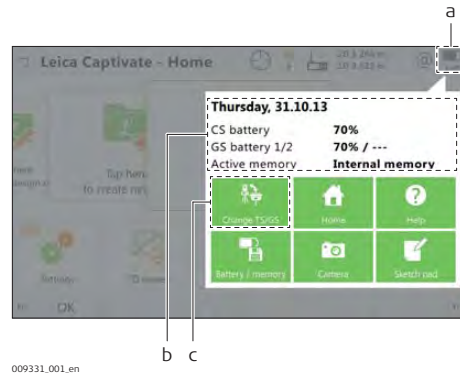

- a Icon in icon area
- b Status information
- c Bubble icon

Description of the icon pop-up bubbles

Refer to the individual chapters for more information.

Aim & Search

Status Information	Functionality
<ul style="list-style-type: none">• Current target aiming• PowerSearch filter	<ul style="list-style-type: none">• Switch between manual/automatic aiming• Turn target lock on/off• Locks onto a prism by searching or by waiting for a prism to come into the field of view• Switch between PowerSearch left/right

Measure & Target

Status Information	Functionality
<ul style="list-style-type: none">• Current target with defined constants• Type of distance measurement	<ul style="list-style-type: none">• Switch between measurements to any surface or to prisms• Set continuous or non-continuous measurement mode• Select targets• Turn the red laser of the reflectorless EDM on/off

Instrument

Status Information	Functionality
<ul style="list-style-type: none">• Current setup ID, instrument height and level status	<ul style="list-style-type: none">• Change the face of the telescope• Turn the telescope to a certain direction• Electronic level bubble and compensator settings• Turn the instrument using keyboard arrow keys• Information related to the current setup on the instrument

Hz and V

Status Information	Functionality
<ul style="list-style-type: none">• Current horizontal and vertical angle• Tap to see pole height• Current horizontal and vertical angle• Tap to see pole height and slope distance	-

GS Position

Status Information	Functionality
<ul style="list-style-type: none">• Current GNSS position	<ul style="list-style-type: none">• Information related to the current antenna position and the speed of the antenna.

Satellite Tracking

Status Information	Functionality
<ul style="list-style-type: none">• Number of satellites available and satellites used per satellite system G (GPS), R (GLONASS), E (Galileo) or B (BeiDou)	<ul style="list-style-type: none">• Satellites ordered by the elevation angle, satellite information in a graphical way, used almanac• Information related to logging of raw observations.

RTK Data Link

Status Information	Functionality
<ul style="list-style-type: none">Seconds since last RTK message was sent/receivedPercentage of real-time data received from the base compared with data received from the antenna within the last minute	<ul style="list-style-type: none">Load an existing RTK profile using the RTK rover wizard.Information related to real-time data, for example the data link and the device used to transfer real-time dataStatus Internet connectionForce a new initialisationChange the radio channel

2D and 1D

Status Information	Functionality
<ul style="list-style-type: none">Current 2D coordinate quality of computed positionCurrent height coordinate quality of computed positionTap to see pole heightTap to see 3D position quality	-

Connections

Status Information	Functionality
<ul style="list-style-type: none">Internet online or not	<ul style="list-style-type: none">Status Bluetooth connectionStart Leica ExchangeStart Start Active Assist

Battery and time

Status Information	Functionality
<ul style="list-style-type: none">Date and timeRemaining power capacity for the batteryActive memory	<ul style="list-style-type: none">Select instruments to useReturn to Leica Captivate - Home menuStart online helpUsage and status of battery and memoryBegin the camera functionCreate a sketch on a virtual piece of paper

5.2

Icon Pop-Up Bubble: Aim & Search



5.2.1

Bubble Icons

Bubble icons

Icon	Description
Auto aiming	Sets Aim at target: Automatic .
Manual aiming	Sets Aim at target: Manually .

Available for **Aim at target: With lock**. For robotic instruments and the remote operation with CS20.

Icon	Description
Search & lock	Searches for a prism to lock on.
Wait & lock	Locks to a prism as soon as it enters the field of view of automatic aiming. When previously locked to a prism and target lock was lost. Works on all prisms and tape targets.  A PowerSearch helps to lock to shaking prisms.
Target lock off	Stops the lock.
Target lock on	Sets Aim at target: With lock .
Target lock off	Sets Aim at target to the previous non-lock setting.
Filter learn	Starts a PowerSearch scan by doing three times a 360° scan with different vertical positions of the telescope. The PowerSearch scan finds prisms and other reflective spots in the surrounding of the instrument. Around each found prism or reflective spot, an exclusion area is defined. The exclusion area has the dimension of Hz = ± 1 gon, V = ± 50 gon and d = ± 12 m is defined.
Filter on	Available when Filter learn was used before. Turns on the PowerSearch filter and excludes the learned prisms from a PowerSearch.
Filter off	Available when Filter learn was used before. Turns off the PowerSearch filter and includes all prisms in a PowerSearch.
PowerSearch	Prisms are searched for with PowerSearch in the PowerSearch window when this icon is used.  If this icon is selected and Meas any surface is still set, then this setting is changed to Measure prism .

5.3

Icon Pop-Up Bubble: Measure & Target

Bubble icons

Icon	Description
Meas any surface	To measure to any surface (reflectorless). Automatically sets Aim at target: Manually .
Measure prism	To measure to prisms.
Meas continuous	To set the distance measurements to continuous.
Meas single shot	To set the distance measurements to the previous non-continuous mode.
Targets	To select a prism.
Red laser on	To turn the red laser of the reflectorless EDM on.
Red laser off	To turn the red laser of the reflectorless EDM off.

5.4 Icon Pop-Up Bubble: Instrument

5.4.1 Bubble Icons

Bubble icons

Icon	Description
Current setup	Information related to the current setup on the instrument. Refer to "5.4.2 Current setup ".
Turn to Hz/V	To turn the instrument to a specific entered position. Refer to "5.4.3 Turn to Hz/V ".
Arrow keys	To turn the instrument using the arrow keys. Refer to "5.4.4 Arrow keys ".

5.4.2 Current setup

TS Current Setup Info

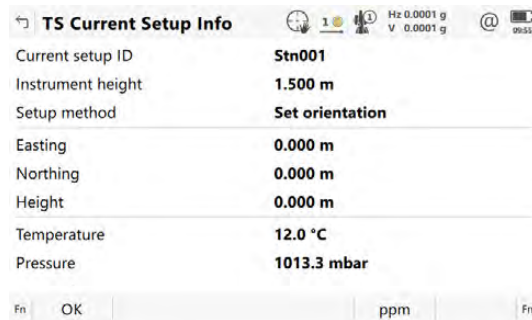

The screenshot shows the 'TS Current Setup Info' panel with the following settings:

Current setup ID	Stn001
Instrument height	1.500 m
Setup method	Set orientation
Easting	0.000 m
Northing	0.000 m
Height	0.000 m
Temperature	12.0 °C
Pressure	1013.3 mbar

At the bottom, there are function keys: Fn, OK, ppm, and Fn.

Key	Description
OK	To exit the panel.
ppm/Scale fctr	To switch between displaying the setup scale factor and the setup ppm.

Description of fields

Field	Description
Current setup ID	The current setup.
Instrument height	Instrument height of the current setup.
Setup method	The setup method used for the current setup.
Easting	Easting value of the instrument position.
Northing	Northing value of the instrument position.
Local ellipsoid height or Height	For a selected coordinate system, ellipsoidal height and elevation can be displayed.
Temperature	Temperature set on the instrument.
Pressure	Pressure set on the instrument.
Atmospheric ppm	Atmospheric ppm set on the instrument.
Setup ppm	Ppm of the current setup.
Setup scale	Scale factor of the current setup.

Description

This panel is used when the instrument is controlled remotely and when the telescope must be turned to a certain direction.

Turn Instrument to Hz/V, Absolute page



Key	Description
OK	To return to Leica Captivate - Home menu. The instrument turns to the prism.
Page	To change to another page on this panel.

Description of fields

Field	Option	Description
Azimuth	Editable field	Oriented horizontal direction for the instrument to turn to.
Angle right	Editable field	Horizontal angle from the backsight point for the instrument to turn to. Available when H_z angle display: North azimuth is set in Regional, Angle page.
V angle	Editable field	Vertical direction for the instrument to turn to.

Next step

Page changes to the **Relative** page.

Turn Instrument to Hz/V, Relative page

The values are added to the current telescope position to calculate the new direction for the telescope to turn to.

Description of fields

Field	Option	Description
Difference in H_z angle	Editable field	Angular difference for the horizontal angle to turn to.
Difference in V angle	Editable field	Angular difference for the vertical angle to turn to.

Next step

Press **OK**. The instrument turns to the prism.

For **Aim at target: Automatic** an automatic aiming measurement is performed. If no prism was found, the instrument turns to the position typed in.

For **Aim at target: With lock** the instrument locks on the prism.

The  icon is displayed.

If no prism was found, the instrument turns to the position typed in.

5.4.4

Arrow keys

Description

The instrument can be turned using the keyboard arrow keys on the instrument or field controller, or the arrow keys displayed on the touch screen.

When this panel is accessed, the EGL is turned on automatically. When you exit the panel, the EGL is turned off.

Turn Using Arrow Keys

Use the arrow keys to start the telescope movement.

Press an arrow key again to speed up the movement. Press any of the other arrow keys while the instrument turns to stop the movement.

Press **OK** to stop the instrument movement.

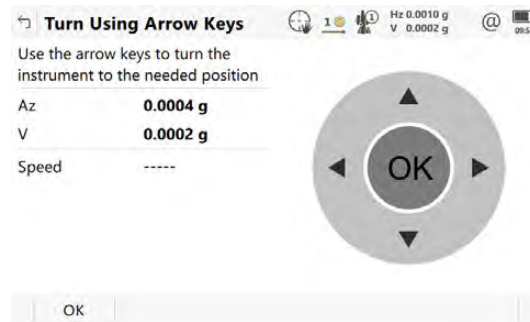

Key	Description
OK	To return to Leica Captivate - Home menu.

Description of fields

Field	Option	Description
Speed	-----, Very slow , Slow , Medium and Fast	Displays the rotational speed of the instrument. Press the same arrow key to change the speed.

5.5

Icon Pop-Up Bubble: GS Position

5.5.1

Current position

Description

This panel shows information related to the current antenna position and the speed of the antenna. For real-time rover settings, the baseline vector is also shown. 3D viewer shows the current position in a graphical format.

Current GS position, Position page



Key	Description
OK	To return to the Leica Captivate - Home .
Page	To change to another page on this panel.
Fn Coord	To see other coordinate types. Local coordinates are available when a local coordinate system is active.
Fn Height	To see height as elevation. Available when local grid coordinates are displayed.
Fn Ell Ht	To see height as ellipsoidal height. Available when local grid coordinates are displayed.

Description of fields

Field	Description
Position latency	The latency of the computed position. Latency is mostly due to time required for data transfer and computation of position. Depends on the use of the prediction mode.
Position quality and Height quality	Available for phase fixed and code only solutions. The 2D coordinate and height quality of the computed position.
HDOP and VDOP	Available for navigated solutions.

Next step

IF	THEN
the instrument is a real-time rover	Page changes to the Baseline page.
the instrument is not configured for real-time	Page changes to the Speed page.
the instrument is a real-time base	OK exits Current GS position .

Current GS position, Baseline page

Information on the baseline vector is displayed.

Next step

Page changes to the **Speed** page.

**Current GS position,
Speed page**

Description of fields

Field	Description
Horizontal speed	The speed over ground in the horizontal direction.
On bearing	Available for local coordinate systems. The bearing for the horizontal direction related to the North direction of the active coordinate system.
Vertical speed	The vertical component of the current velocity.

Next step

IF	THEN
the instrument is a GS18 and the tilt compensation is active	Page changes to the Tilt page.
the instrument is not a GS18 or the tilt compensation on a GS18 is inactive	OK exits Current GS position .

**Current GS position,
Tilt page**

Available for GS18 with **Use tilt compensation** checked in **Tilt Compensation**.

The fields are updated according to the setting for **GS position update rate** in **Screen, Audio & Text Input**.

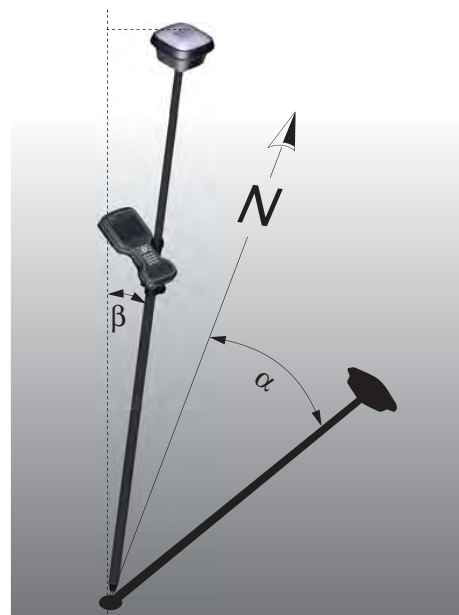

α Direction of tilt
 β Tilt

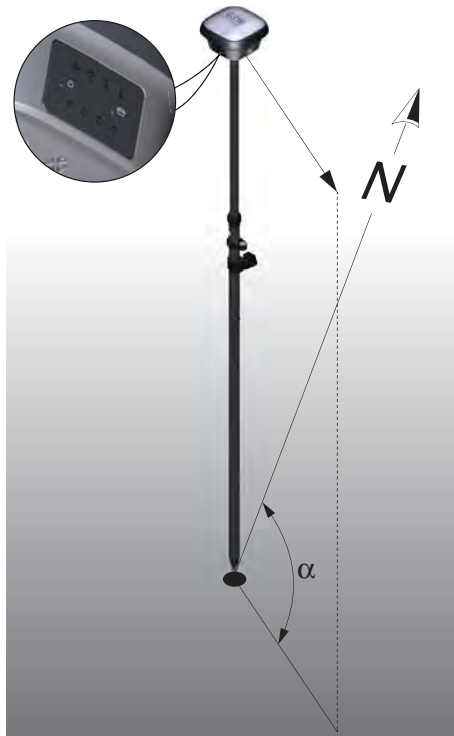

0014307.001

α GS heading

Description of fields

Field	Description
Local time	The current local time.
Overall tilt quality	The current 3D coordinate quality of the computed position.
Tilt	The angle between the vertical and the tilted pole of the antenna. This angle is calculated by the GS18.
Tilt quality	The accuracy of the tilt angle of the antenna.
Direction of tilt	The azimuth of the tilted antenna pole.
Direction of tilt quality	The accuracy of the azimuth angle of the tilted antenna pole.
GS heading	The direction in which the keyboard of the GS18 faces.
GS heading quality	The accuracy of the direction in which the keyboard of the GS18 faces.

Next step

OK exits **Current GS position**.

5.6 Icon Pop-Up Bubble: Satellite Tracking

5.6.1 Bubble Icons

Bubble icons

Icon	Description
Satellite tracking	Information related to the tracked satellites. Refer to "5.6.2 Satellite tracking ".
Data logging	Information related to the logging of raw observations. Refer to "5.6.3 Data logging ".

5.6.2 Satellite tracking

Description

This panel shows information related to the tracked satellites ordered by the elevation angle.

Rover Satellite Tracking, GPS/Glonass/Galileo/BeiDou/Augmentation page

The screenshot shows the 'Rover Satellite Tracking' interface. At the top, it displays 'GPS Skyplot Almanac' and a search icon. Below this is a table with columns for satellite ID, Elevation (Elev), Azimuth, and Signal-to-Noise Ratio (S/N) for L1 and L2 frequencies. The table lists several satellites: G27 (Elev: 88, Azimuth: 329, S/N L1: 50, S/N L2: 49), G06 (Elev: 80, Azimuth: 134, S/N L1: 49, S/N L2: 44), G03 (Elev: 77, Azimuth: 286, S/N L1: 50, S/N L2: 45), G22 (Elev: 63, Azimuth: 120, S/N L1: 50, S/N L2: 45), and G19 (Elev: 51, Azimuth: 302, S/N L1: 49, S/N L2: 44). At the bottom of the table, there are navigation buttons: 'Fn', 'OK', 'Base', 'Health', 'More', 'Page', and 'Fn'.

Key	Description
OK	To return to the Leica Captivate - Home menu.
Base / Rover	To change between the SNR values of rover and base.
Health	To view the numbers of satellites categorised in good, bad and unavailable.
More	To display information about the SNR values for satellites.
Page	To change to another page on this panel. The Galileo page is unavailable with GS08plus.

Description of metadata

Metadata	Description
-	The Pseudo Random Noise number (GPS), the Slot number (GLONASS), the Space Vehicle number (Galileo, BeiDou) or the name (Terrastar) of the satellites.
Elev	The elevation angle in degrees. The arrows indicate if the satellite is rising or falling.
Azimuth	The azimuth of the satellite.

Metadata	Description
S/N L1, S/N L2, S/N L5, S/N E5b and S/N AltBOC	The SNR on L1, L2 and L5 for GPS, on L1 and L2 for GLONASS, on E1, E5a, E5b and AltBOC for Galileo and on B1 and B2 for BeiDou. If the signal is not being used in the position calculations, the number is shown in brackets.

Next step

Page changes to another page on this panel.

Rover Satellite Tracking, Skyplot page

Shows all currently tracked satellites.

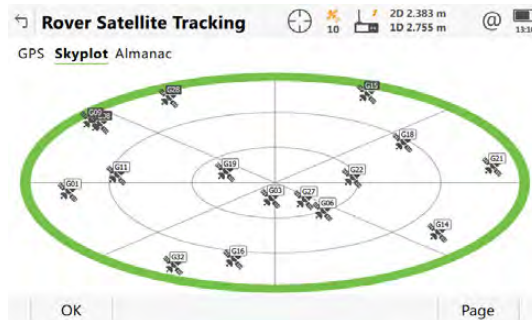

Satellites below the **Cut-off angle** configured in **Satellite Tracking** are marked grey.

The part of the skyplot between the 0° elevation and the cut-off angle is marked grey.



Key	Description
OK	To return to the Leica Captivate - Home menu.
GPS off / GPS on	To hide or show the GPS satellites (shown by the prefix G).
GLO off / GLO on	To hide or show the GLONASS satellites (shown by the prefix R). Available when Glonass is activated in Satellite Tracking .
GAL off / GAL on	To hide or show the Galileo satellites (shown by the prefix E). Available when Galileo is activated in Satellite Tracking .
BDS off / BDS on	To hide or show the BeiDou satellites (shown by the prefix C). Available when BeiDou is activated in Satellite Tracking .
Page	To change to another page on this panel.

Description of symbols

Symbol	Description
	Satellites above the Cut-off angle configured in Satellite Tracking .
	Satellites below the Cut-off angle configured in Satellite Tracking .

Next step

Page changes to the **Almanac** page.

Rover Satellite Tracking, Almanac page

The **Almanac** page shows

- the date of the used almanacs, for each GNSS constellation configured
- as shown on the skyplot, the number of satellites tracked and the number of satellites available above the cut-off elevation mask.

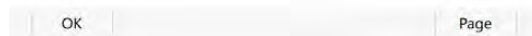
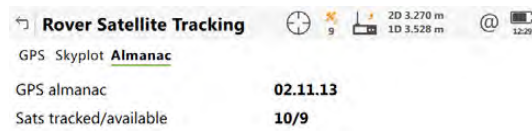

Key	Description
OK	To return to the Leica Captivate - Home menu.
Page	To change to another page on this panel.

Next step

OK exits the panel.

Base Satellite Tracking

The satellite tracking information shown for the base is identical with the information shown for the rover.

5.6.3

Data logging

Description

This panel shows information related to logging of raw observations.

GNSS Data Logging Status, Logging information page

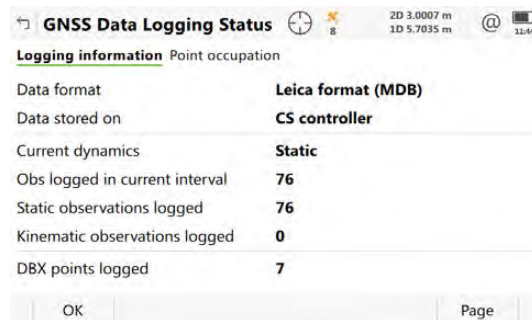

Key	Description
OK	To return to the Leica Captivate - Home menu.
Page	To change to another page on this panel.

Description of fields

Field	Description
Data format	Shows if raw data is saved and if so in which format.
Data stored on	Shows where the data is saved.
Current dynamics	Indicates if the instrument is static or moving.
Obs logged in current interval	The number of observations logged in the current interval.
Static observations logged	The number of static epochs recorded in the current job.
Kinematic observations logged	The number of moving epochs recorded in the current job.
DBX points logged	The number of points stored to the database.

Next step

Page changes to the **Point occupation** page.

GNSS Data Logging Status, Point occupation page

Description of fields

Field	Description
Current dynamics	Shows if the instrument is moving or not.
GDOP	Current GDOP.
Logging rate	Rate at which raw observations are being recorded.
Number of moving observations	The number of logged moving raw observations. Reset as soon a new moving interval starts.
Logging data from more than 5 sats since	The time for how long five or more satellites are tracked on L1 and L2 without interruption. If fewer than five satellites were tracked, the counter is reset. The counter is not reset after Measure , Stop or Store .

Field	Description
Measurement completed	The percentage of collected data required for successful processing. It is a conservative estimate based on a 10 - 15 km baseline. The criteria used to display this value depend on the settings for Automatically stop point measurement in Leica Captivate - Home: Settings\Point storage\GS quality control .
Time to go	The estimated time in hours, minutes and seconds until the configured stop criteria is reached. The criteria used to display this value depend on the settings for Automatically stop point measurement in Leica Captivate - Home: Settings\Point storage\GS quality control .

Next step

Page changes to the **RTK base** page.

GNSS Data Logging Status, RTK base page

As shown below, the name of the page changes depending on the type of base used.

Name of page	Description
RTK base page	Base is a real base station.
Base (Nearest) page	Base is the closest to the rover determined by for example SmartNet.
Base (i-MAX) page	Base information is individualised Master-Auxiliary corrections determined and sent by for example SmartNet.
Base (MAX) page	Base information is Master-Auxiliary corrections determined and sent by for example SmartNet.
Base (VRS) page	Base is a virtual base station.
Base (FKP) page	Base information is area correction parameters.

Description of fields

Field	Option	Description
Logging rate	A time in sec	The logging rate at the base. This information is shown if the real-time message format supports this information and raw observations are being logged at the base.
	-----	Raw observations are not being logged, or status information is not supported by RTK format.

Next step

OK exits **GNSS Data Logging Status**.

5.7 Icon Pop-Up Bubble: RTK Data Link

5.7.1 Bubble Icons

Bubble icons

Icon	Description
RTK data link stat	Available when RTK is configured. Opens the status panel RTK Data Link Status or RTK1 Data Link Status/RTK2 Data Link Status . Refer to "16 RTK rover wizard". Shows also information related to the incoming data from active devices.
Initialize RTK	Refer to "5.7.3 Initialize RTK".
Auto coord on	Available for RTK data format: RTCM v3 or Leica 4G . To set an RTCM coordinate system received by a reference network as active coordinate system.
Change channel	To open the settings panel Radio Settings . Refer to "19.3 Radios for GPS Real-Time".
Start RTK stream	To start streaming RTK data.
Stop RTK stream	To stop streaming RTK data.

5.7.2 RTK data link stat

Description

This panel shows information related to real-time data, for example the data link and the device used to transfer real-time data.

RTK Data Link Status, General page

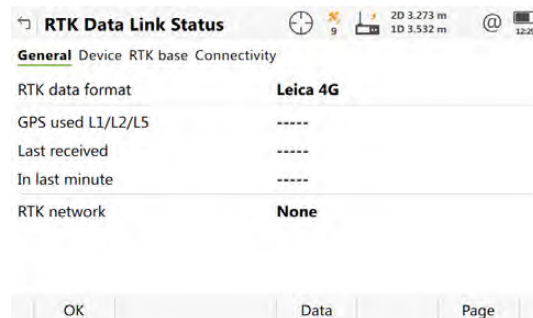

Key	Description
OK	To exit the panel.
Data	To view the data being received. Depending on the RTK data format , the shown data differ.
Page	To change to another page on this panel.

Description of fields

Field	Description
RTK data format	The received real-time data format message type.
GPS used L1/L2/L5	The number of satellites on L1, L2 and L5 being used in the current position solution.

Field	Description
GLO used L1/L2	Available if Glonass is activated in Satellite Tracking . The number of satellites on L1 and L2 being used in the current position solution.
GAL used E1/E5a	Available if Galileo is activated in Satellite Tracking . The number of satellites on E1 and E5a being used in the current position solution.
GAL used E5b/ABOC	Available if Galileo is activated in Satellite Tracking . The number of satellites on E5b and AltBOC being used in the current position solution.
BDS used B1/B2	Available if BeiDou is activated in Satellite Tracking . The number of satellites on B1 and B2 being used in the current position solution.
Last data sent	Available for RTK base. Seconds since the last message from the base was sent.
Last data received	Available for Rover Satellite Tracking. Seconds since the last message from the base was received.
In last minute	Available for Rover Satellite Tracking. The percentage of real-time data received from the base compared with the data received from the antenna within the last minute. This percentage indicates how well the data link is working.
RTK network	Available for an Rover Satellite Tracking. The type of base network in use.

Next step

Page changes to the **Device** page.

RTK Data Link Status, Device page

The content of this page differs for each type of device in use.

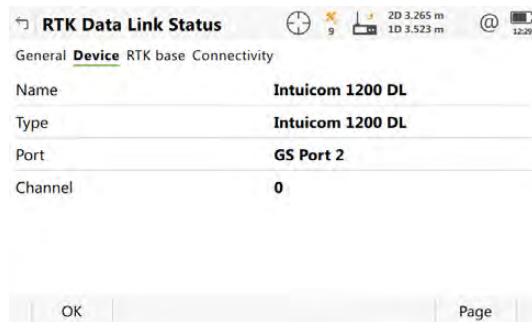

Key	Description
OK	To exit the panel.
Page	To change to another page on this panel.

Description of fields

For all devices available

Field	Description
Name	The name of the device.

For RS232

Field	Description
Type	The type of device.
Port	The port to which the device is connected.
Bluetooth	Available if device is connected using Bluetooth. Indicates the state of the connection.

For digital cellular phones and modems

Field	Description
Type	The type of device.
Port	The port to which the device is connected.
Firmware	The software version of the attached digital cellular phone.
Operator	The name of the network operator in which the digital cellular phone is operating.
Network type	The type of reference network selected in RTK Rover Settings . Refer to "RTK Rover Settings, RTK network page".
Status	The current mode of the digital cellular phone. The options are Unknown, Detection and Registered.
Bluetooth	Available if device is connected using Bluetooth. Indicates the state of the connection. Unavailable for CS modem.
Signal	Indication of received signal strength of the digital cellular phone network.

For radios

The available fields depend on the radio type.

Field	Description
Type	The type of device.
Port	The port to which the device is connected.
Channel	The radio channel.
Frequency	The current set frequency of the radio.
Channel spacing	Channel spacing assigned to the channel in kHz. The frequency spacing between channels depends on the radio used.
Firmware	The software version of the attached radio.

For Internet on the rover

Field	Description
TCP/IP port	TCP/IP port number in use.
IP address	IP address of the connected client.
Duration	The time length since when the instrument is connected to the Internet.
KBytes received	The amount of data received from the Internet in kilobyte.
KBytes sent	The amount of data sent to the Internet in kilobyte.

For Internet on the base

Field	Description
TCP/IP port	TCP/IP port number in use.
Clients connected	The number of connected clients and the number of allowed client connections as configured in Internet Port Connection .

Next step

Page changes to the **RTK base** page.

RTK Data Link Status, RTK basepage

As shown below, the name of the page changes depending on the type of base being used.

Name of page	Description
RTK base page	Base is a real base station.
Base (Nearest) page	Base is the closest to the rover determined by for example SmartNet.
Base (i-MAX) page	Base information is individualised Master-Auxiliary corrections determined and sent by for example SmartNet.
Base (MAX) page	Base information is Master-Auxiliary corrections determined and sent by for example SmartNet.
Base (VRS) page	Base is a virtual base station.
Base (FKP) page	Base information is area correction parameters.

Description of fields

Field	Description
Point ID	The name of the reference.
RTK base ID	An identification for a base station. The ID can be converted into a compact format to be sent out with real-time data in all real-time data formats. It is different from the point ID of the base station.

Field	Description
Ground marker to antenna reference point	<ul style="list-style-type: none"> For RTK data format: Leica, RTK data format: Leica 4G, RTK data format: RTCM v3 or RTK data format: RTCM 9,2 v2/RTCM 1,2 v2 with RTCM version: 2.3: The antenna height at the base from the marker to the MRP. For RTK data format: CMR/CMR+ and RTK data format: RTCM 18,19 v2 or RTK data format: RTCM 18,19 v2 with RTCM version: 2.2: The antenna height at the base from the marker to the phase centre. For all other RTK data format-----: is displayed because the data format does not include information about the antenna height.
Coordinates of	<p>The coordinates for the base station which are transferred depend on the active real-time data format.</p> <ul style="list-style-type: none"> For real-time messages which include antenna height and antenna type: Marker. For real-time messages which do not include antenna information: Phase Centre of L1.
Number of aux ref	The number of active auxiliary base stations from which data is received. Availability depends on selected network.
Antenna at base	The antenna used at the base.
Sensor type at base	The instrument type used at the base.

Next step

IF	THEN
other coordinate types must be viewed	Fn Coord. Local coordinates are available when a local coordinate system is active.
another page must be accessed	Page.
this panel must be quit	OK exits the panel.

RTK Data Link Status, Connectivity page

This panel shows the status real-time connectivity as dynamic troubleshooting panel. It shows the success of each of the steps in the connectivity to receive real-time corrections. If one step fails or is skipped, the check box is unchecked.

As each step is successfully completed, the check box is activated.

RTK Data Link Status, DynDNS page

The page shows the status of the DynDNS connection.

This page is available, if DynDNS is activated. Refer to "18.2 CS internet / GS internet / TS Internet".



Unavailable for CS35. Use the status panel in Windows.

On base

Field	Option	Description
DynDNS status		Available on base.
	Error	DynDNS is active but the IP address could not be updated at the DynDNS service.
	Active	DynDNS is active and has updated the IP address.
	Off	DynDNS is inactive.
Last update	Display only	Available on base. The time and the date of when the IP address was last updated at the DynDNS service by the GS.
Current registered IP	Display only	Available on base. The last IP address that has been updated for the GS.

Real-Time Input Data

The following provides additional information on the satellite data received using real-time message. Information of those satellites is displayed, which are used on both base and rover.

Access

Data on **RTK Data Link Status, General** page.

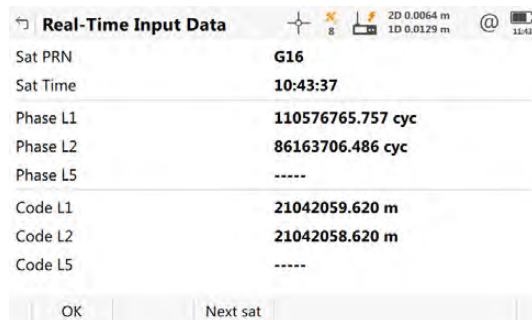

The screenshot shows a mobile application interface titled "Real-Time Input Data". At the top, there are several status icons: a location pin, a signal strength indicator, a battery level indicator, and a time display showing 11:43. Below the title, the data for satellite G16 is displayed in a list format:

Sat PRN	G16
Sat Time	10:43:37
Phase L1	110576765.757 cyc
Phase L2	86163706.486 cyc
Phase L5	-----
Code L1	21042059.620 m
Code L2	21042058.620 m
Code L5	-----

At the bottom of the screen, there are two buttons: "OK" and "Next sat".

Key	Description
OK	To return to RTK Data Link Status .
Next sat	To display information on the satellite with the next higher number.
Prev sat	To display information on the satellite with the next lower number. Available when Next sat was pressed before.

Description of fields

The data being received from the satellites and the layout of the panel depend on the active real-time data format.

Field	Description
Sat PRN	The PRN number (GPS), the Slot number (GLONASS) or the Space Vehicle number (Galileo, BeiDou) of the satellites shown with the prefix G (GPS), R (GLONASS), E (Galileo) or C (BeiDou).
Sat Time	The GPS time of the satellite.
Phase L1, Phase L2, Phase L5	The number of phase cycles from the antenna to the GPS satellite on L1, L2 and L5.
Phase L1, Phase L2	The number of phase cycles from the antenna to the GLONASS satellite on L1 and L2.
GAL used E1/E5a, GAL used E1/E5a	The number of phase cycles from the antenna to the Galileo satellite on E1, E5a, E5b and Alt-BOC.
Phase B1, Phase B2	The number of phase cycles from the antenna to the BeiDou satellite on B1 and B2.
Msg 18 L1, Msg 18 L2	The uncorrected carrier phases for L1 and L2.
Msg 20 L1, Msg 20 L2	The carrier phase corrections for L1 and L2.
Code L1, Code L2, Code L5	The pseudorange from the antenna to the GPS satellite for L1, L2 and L5.
Code L1, Code L2	The pseudorange from the antenna to the GLONASS satellite on L1 and L2.
GAL used E1/E5a, GAL used E1/E5a	The pseudorange from the antenna to the Galileo satellite on E1, E5a, E5b and Alt-BOC.
Code B1, Code B2	The pseudorange from the antenna to the BeiDou satellite on B1 and B2.
Msg 19 L1, Msg 19 L2	The uncorrected pseudoranges for L1 and L2.
Msg 21 L1, Msg 21 L2	The pseudorange corrections for L1 and L2.

5.7.3

Initialize RTK

Requirements

The active working style is a real-time rover setting.

Initialize RTK

If the instrument currently has a fixed solution, the initialisation starts automatically.

The current ambiguity solution is discarded and a new initialisation is gained when the ambiguities are solved.

5.8

Icon Pop-Up Bubble: Connections

5.8.1

Bubble Icons

Bubble icons

Icon	Description
Bluetooth	To define Bluetooth connections.

Icon	Description
Leica Exchange	To start Leica Exchange . Leica Exchange is an online service that allows the data exchange between two users of the service. Refer to "29.7 Leica Exchange".
Start Active Assist	To connect to the Active Assist service. Refer to "5.8.2 Active Assist".
End Active Assist	To disconnect from the Active Assist service.

5.8.2

Active Assist

Description

Active Assist is an online support tool that allows Leica technical support to gain remote access to your instrument or field controller.



Valid CCP and Active Assist licences are required to use Active Assist.

Using Active Assist step-by-step

1. Establish a connection to the Internet.
2. Call your local technical support.
3. Select **Start Active Assist** to connect to the Active Assist service.
4. Quote the equipment number shown on the panel to your supporter.
-  Leica technical support has now remote access to your TS instrument or field controller.
5. Select **End Active Assist** to disconnect from the Active Assist service once the session has finished.

5.9

Icon Pop-Up Bubble: Battery and Time

5.9.1

Bubble Icons

Bubble icons

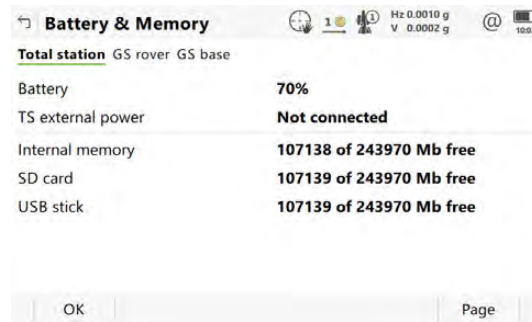

Icon	Description
Change TS/GS	To switch between GS and TS mode.
Home	To return to the Leica Captivate - Home menu.
Help	To start the online help.
Battery / memory	Information related to usage and status of battery and memory. Refer to "5.9.2 Battery / memory".
Camera	To capture an image with the integrated camera. Available when the cameras are activated in Leica Captivate - Home: Settings\TS instrument\Cameras . Refer to "5.9.3 Camera".
Sketch pad	To create a sketch on a virtual piece of paper. Refer to "5.9.4 Sketch pad".

Battery & Memory





Key	Description
Page	To change to another page on this panel.

Description of fields

Field	Description
Battery, Battery 1 or Battery 2	<p>The percentage of remaining power capacity for the internal battery is displayed numerically. If no information for a field is available, for example no battery is inserted, then ----- is displayed.</p> <p> On the MS60/TS60, if the battery gets charged, (charging) is stated behind the percentage of the battery power level.</p> <p> When the battery is getting low on the TS, a warning message is displayed on the CS.</p>
TS external power, GS external power or CS external power	<p>Shows if an external power supply is connected. If an external battery is connected, the percentage of remaining power capacity is displayed numerically. Applies also to wall plugs.</p>
Internal memory, SD card or USB stick	<p>The total/free memory for data storage on the data storage device. If no information for a field is available, for example no data storage device is inserted, then ----- is displayed.</p> <p> The CS35 has two USB ports. The USB stick, that was inserted first, is used.</p>

Taking a picture step-by-step

1. Aim the camera to the desired target.
2. Check the view at the display.
3. Click **Capture** to take the picture.
 -  **Capture** changes to **Store**.
4. Click **Store**.
 -  The image is stored in the DBXJOBIMAGES folder of the data storage device.

5. Select an option from the message window to link or not link the image.

5.9.4

Sketch pad

Description

The field sketch functionality is used to create a sketch on virtual paper. Sketching is possible on predefined or on user-defined templates. User-defined templates can, for example, include a company logo or check boxes for tasks that must be done.

The sketch is stored as image in jpg format. The jpg file is stored in the DBX \JOB\IMAGES folder of the data storage device.

The predefined templates are optimised for A4 printout. User-defined templates can be optimised for any format.

A screenshot cannot be made from the field sketch.

Choose Sketch Template

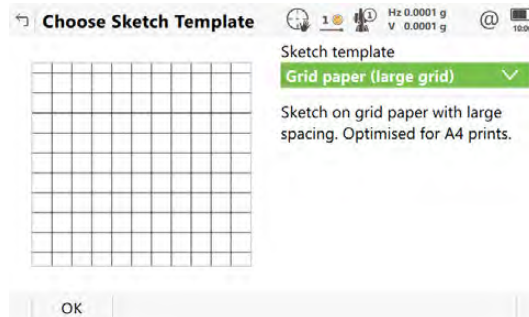

Key	Description
OK	To create a copy of the selected sketch template and to start sketching.

Description of fields

Field	Option	Description
Sketch template	Plain paper, Lined paper-narrow, Lined paper-wide, Grid paper (small grid) or Grid paper (large grid)	The predefined sketch templates.

Field	Option	Description
	User-defined templates	The user-defined templates must be jpg files with a maximum of five megapixels. The templates are stored in the CONFIG\SKETCH_TEMPLATES folder of the data storage device. To make a user-defined template selectable in the list, transfer the template to the internal memory in Leica Captivate - Home: Settings\Tools\Transfer user objects . Refer to "29.1 Transfer user objects".

Next step

Select a template. **OK** to access **Sketch Pad**.

Sketch Pad

Refer to "Tools" for information on the toolbar.



Key	Description
Store	To store and link the field sketch.

6 Job Menu - Jobs

6.1 Overview

Description	<p>Jobs</p> <ul style="list-style-type: none">• structure surveying projects.• contain all points, lines, images and scans that are measured/recorded and stored.• can be downloaded to Infinity for post-processing or for data transfer to a further program.• can be uploaded from Infinity, for example, for stake out operations.• can be stored on the data storage device or the internal memory.
Type of jobs	<ul style="list-style-type: none">• Data jobs. Explained in this chapter.• DTM files. Refer to "51.6 Staking Out a DTM or Points & DTM".• Road alignment files.
Default job	<p>A default job is available on the instrument after formatting the data storage device, inserting a previously formatted data storage device or deleting all jobs.</p>
Job	<p>Data is stored to a job. After formatting the data storage device, the default job is used until a user-defined job is created and selected.</p> <p>The properties of the job determine some system properties, such as the codelist, coordinate system and TS scale factor.</p> <p>When a job becomes the job, then the sort and filter settings of this job are saved in the System RAM. If the data storage device is formatted then these last used sort and filter settings are used for the default job.</p>

6.2 Creating a New Job



Access	<p>Select Leica Captivate - Home: Tap here to create new job.</p> <p>OR</p> <p>In Leica Captivate - Home press Fn New job.</p>
---------------	---

New Job, General page

The screenshot shows the 'New Job' configuration screen. At the top, there are status icons and sensor data (Hz 0.0004 g, V 0.0002 g). Below that, there are tabs for 'General', 'Coordinate system', 'Codelist', 'Linked jobs', 'CAD files', and 'Linked design'. The 'General' tab is active, showing input fields for 'Name', 'Description', and 'Creator', each with a green bar above it. The 'Job stored to' dropdown is set to 'Internal memory'. There are two checkboxes: 'Display in job carousel' (checked) and 'After storing job, capture an image' (unchecked). At the bottom, there are 'Store' and 'Page' buttons.

Key	Description
Store	To store the settings.
Page	To change to another page on this panel.

Description of fields

Field	Option	Description
Name	Editable field	A unique name for the new job. The name can be up to 16 characters long and include spaces. Input required.
Description	Editable field	Two lines for a detailed description of the job, for example, work to be performed or the classes contained in the job. Input optional.
Creator	Editable field	The name of the person who is creating the job. Input optional.
Job stored to	Selectable list	<p>The device on which the new job is stored. Depending on the instrument options, this field may be a display only field.</p> <p> For CS35: Jobs must be created on the internal memory. The creation of jobs on the USB stick is not supported.</p> <p> For jobs stored on the SD card, the  icon is shown on the job tile in the Leica Captivate - Home menu.</p>
Display in job carousel	Check box	<p>When this box is checked, the job is visible in the job carousel.</p> <p>When this box is not checked, the job is invisible in the job carousel. Exclude jobs from the job carousel to reduce the scrolling effort.</p>
After storing job, capture an image to display in the Home screen	Check box	When this box is checked: After pressing Store , the camera on the current instrument will start. A picture can then be captured. The picture is automatically added to the job image in Leica Captivate - Home .

Next step

Page changes to the **Coordinate system** page.

New Job, Coordinate system page

Description of fields

Field	Option	Description
Coordinate system	Selectable list	Choosing a coordinate system attaches it to the job. A coordinate system is necessary to transform GNSS coordinates to a local grid format.

All other fields on this panel are display only fields. They depend on the transformation type of the selected coordinate system.

Next step

Page changes to the **Codelist** page.

New Job,
Codelist page

Description of fields

Field	Option	Description
Codelist	Selectable list	Choosing a codelist copies the codes to the job. Codes are editable. Refer to "6.5 Managing Job Codes".

Next step

Page changes to the **Linked jobs** page.

New Job,
Linked jobs page

Multiple jobs can be linked to a working job. The advantage is, that the list of design points and lines available to be used in some applications can be read from these multiple linked jobs, instead of one single control job.

Linked jobs will overwrite the points and lines from the global design job selected in Design Data.



The source for a control job must be a job from Leica Captivate.

A external format, such as ASCII, XML or DXF must be converted into DBX format first.

Key	Description
Store	To store the settings.
Add	To link a control job to the job. Accesses Choose Linked Jobs . Refer to " Choose Linked Jobs".
Remove	To delete the highlighted control job from the list of linked jobs. The corresponding points and lines will be removed from the data set.
Dataset	To list all points and lines contained in the available and visible linked jobs. The list is updated with the data from the selected jobs to link. Refer to " Dataset".
Page	To change to another page on this panel.
Fn Main job	To make a linked job the main job where created points and lines are stored to.
Fn Log	To view, edit and delete points and lines stored with the job. Points and lines are sorted by time in one list.
Fn State	To change between the options in the metadata for State . To show or hide the linked job data within the data set.

Description of metadata

Metadata	Description
-	The name of the job.

Metadata	Description
State	<p>The state of the job:</p> <ul style="list-style-type: none"> • Visible: The data of the linked job are included in the data set. • Hidden: The data of the linked job are excluded from the data set. • Not available: The source job of the data is not available on any of the data storage devices.
Main Job	<p>Created control data such as points and lines are stored in the main job.</p> <p>To make a job the main job, highlight the job and press Fn Main job.</p> <p>As long as there is at least one available linked job, there must be a main job where the created points and lines are stored if created.</p> <p>If no linked job is available, for example all are deleted, or all are on an SD card which is not inserted, then there is no main job.</p> <p>If the main job is deleted, then the role of main job jumps to another linked job.</p> <p>If the main job is set as Hidden, the role of main job stays in that job.</p>
Source	<p>The data storage device where the job is stored.</p> <p>If the working job and/or linked jobs are moved to another device, the link between both is remembered.</p> <p>Source: ----- indicates that the source job of the data is not available in the expected data storage device.</p> <p> If the data storage device containing one or more control jobs is taken out off the instrument, the jobs will NOT be available in the data set anymore.</p> <p> Every time an app is started, the availability of control jobs is checked. The check ensures the correspondency between the list of linked jobs and the data set.</p>
Date created	The date of when the job was created.

Next step

Page changes to the **CAD files** page.

New Job, CAD files page

If a CAD file is checked, the file is attached to the job when **Store** is pressed. The CAD file can be in the \DATA folder of any data storage device. The new job and the CAD file do not have to be on the same data storage device. CAD heights are supported.

Key	Description
Store	To store the settings. Selected CAD files are available in the job as background maps.
Add	To add another CAD file to the job.
Remove	To delete a CAD file.

Key	Description
State	To show or hide the CAD data.
Page	To change to another page on this panel.
Fn Settings	To define CAD import settings. The settings are applied when importing the CAD data from within the 3D viewer.
Fn Layers	To turn CAD layers on or off.
Fn Log	To view logged data.

Description of metadata

Metadata	Description
-	The name of the CAD files available in the \DATA directory of any data storage device.
Format	The format of the CAD file: dxf, shp or Leica for CAD files that are already attached to other jobs and converted to Leica format.
Size (MB)	The size of the CAD file in megabytes.
Source	The data storage device where the CAD file is stored.
Unit	The units used for the CAD file.

Next step

Page changes to the **Linked design data** page.

New Job, Linked design data page

 The design data selected in this panel, are local design data. In the 3D viewer and when using the apps. the global design data will be overwritten by linked design data from the working job.

Key	Description
Store	To store the settings.
Page	To change to another page on this panel.
Fn Log	To view logged data.

Description of fields

Field	Option	Description
Use a DTM	Check box	When this box is checked, a DTM job can be selected. A DTM job holds DTM (Digital Terrain Model) or TIN (Triangular Irregular Network) data. The files are stored in the \DBX folder or a subfolder of \DBX.
DTM	Selectable list	<p>Holds DTM (Digital Terrain Model) data or TIN (Triangular Irrregular Network) data. The DTM job to be used must be stored in the \DBX directory on the active data storage device.</p> <p>The DTM job is a read-only source of information and cannot be selected as a job.</p>

Field	Option	Description
		 The selected DTM job is visible in the 3D viewer.
Layer	Display only or selectable list	A DTM job can consist of multiple DTM layers or surfaces. These DTM layers can cover different locations, be on top of each other or intersect each other. If there is only one layer in the DTM job, the layer name is displayed as an output. If there are multiple layers, the layer to display in 3D viewer can be selected.
Date created	Display only	The date of when the job was created.
Use a road design	Check box	When this box is checked, a road design can be selected. Contains all the information about the road design. For example, the geometry of the line, the formation layer of the road or the information related to the construction of cuttings and embankments.
Road design	Selectable list	The files are stored in the \DBX folder or a subfolder of \DBX. The data is either typed in manually in the Alignment editor app or converted from a road design package. The road job is a read-only source of information and cannot be selected as a job. The selected Road design is visible in 3D viewer.
Use a rail design	Check box	When this box is checked, a rail job can be selected.
Rail design	Selectable list	Contains all the information about the rail design including the geometry of the centre-line and the rail definition (superelevation). The files are stored in the \DBX folder or a subfolder of \DBX. The rail job is a read-only source of information and cannot be selected as a job. The selected Rail design is visible in 3D viewer.
Use a tunnel design	Check box	When this box is checked, a tunnel job can be selected.
Tunnel design	Selectable list	Contains all the information about the tunnel design including the geometry of the centre-line and the tunnel profile. The files are stored in the \DBX folder or a subfolder of \DBX. The tunnel job is a read-only source of information. The selected Tunnel design is visible in 3D viewer.

Next step

Page changes to the **TS scale** page.

New Job, TS scale page

The geometric distance correction (geometric ppm) is derived from the map projection distortion (map projection ppm), the height above reference datum correction (height ppm) and an individual correction (individual ppm).

The calculation of the map projection ppm follows the formula for the Transversal Mercator Projection. The individual factors are: the scale factor of the line of projection central meridian, Gauss-Krüger = 1.0, UTM = 0.9996, and so on, and the offset from the line of projection.

The calculation of the height ppm is derived from the height of the instrument setup above the reference datum. Normally this is the height above mean sea-level MSL.

New Job Hz 0.0010 g V 0.0002 g 1031

TS scale <>

Scale TS measurements

Compute scale from **Projection & height info** ▾

PPM

Scale at CM

Offset to CM

Map projection ppm

Ground height

Fn Store Page Fn

Key	Description
Store	To store the settings.
Page	To change to another page on this panel.
Fn ppm=0	To set Geometric ppm: 0.0 .

Description of fields

Field	Option	Description
Scale TS measurements	Check box	When this box is unchecked, the scale factor is automatically set to 1 . When this box is checked, the scale factor can be computed based on various options.
Compute scale from	User entered scale factor	To enter only the scale factor.
	User entered ppm	To enter only the geometric ppm value.
	Current setup	To calculate the ppm/scale factor automatically from the coordinate system and setup position.
	Projection & height info	To enter all values for determining the geometric ppm.

Field	Option	Description
Scale factor	Editable field	The user-entered scale factor. Compute scale from: User entered scale factor.
PPM	Editable field	The individual ppm value. Available for Compute scale from: Projection & height info and Compute scale from: User entered ppm.
Map projection ppm	Display only	The map projection ppm value. If this value cannot be calculated, then ----- is displayed and is also ignored in the calculation of the geometric ppm value. Available for Compute scale from: Projection & height info and Compute scale from: Current setup.
Height ppm	Display only	The height ppm value calculated from the height coordinates of the current setup stored in the internal memory. If this value cannot be calculated, then ----- is displayed and is also ignored in the calculation of the geometric ppm value. Available for Compute scale from: Projection & height info and Compute scale from: Current setup.
Geometric ppm	Display only	For Projection & height info: Geometric ppm = Map projection ppm + PPM + height ppm value calculated from Ground height. For Current setup: Geometric ppm = Map projection ppm + Height ppm.
Scale at CM	Editable field	The scale at the central meridian. Available for Compute scale from: Projection & height info.
Offset to CM	Editable field	The offset to the central meridian. Available for Compute scale from: Projection & height info.
Ground height	Editable field	The height of the instrument setup above the reference datum. Available for Compute scale from: Projection & height info.

Additional calculation method for the geometric ppm value

The geometric ppm value can also be calculated by a resection calculation. The scale factor from the resection is used for **PPM**.

Individual ppm=(s-1)*10⁶.s=1+ppm*10⁻⁶. The **Geometric ppm** value is calculated with the following:

- **Scale at CM: 1,**
- **Offset to CM: 0,**
- **Map projection ppm: 0** and
- **Ground height: 0.**

Automatic calculation of the geometric ppm value

When **Compute scale from: Current setup**:

- the ppm values for **Map projection ppm**, **Height ppm** and **Geometric ppm** are automatically calculated. The coordinates of the current instrument setup stored in the internal memory are used, which are based on the currently active coordinate system.
- each time an app is accessed, the geometric ppm value is automatically calculated. The coordinates of the current instrument setup stored in the internal memory are used (these coordinates may have been updated), which are based on the currently active coordinate system (this coordinate system may have changed). This way, the user is always working with the correct geometric ppm value.
- when the **None** coordinate system is chosen, then the geometric ppm value cannot be automatically calculated. A message appears, allowing the user to either manually enter the ppm values or accept ppm values of 0.

Choose Linked Jobs





All jobs on the available data storage devices are listed.

Select the jobs you want to link.

Check a box if you want to link the control job to the job.

Key	Description
OK	To return to New Job, Linked jobs page.

Check box behaviour

	Description
	Checks or unchecks the check box of the highlighted job. The behaviour depends on the current status of the check box.
	Checks or unchecks the check box of the highlighted job. The behaviour depends on the current status of the check box.
	Move the focus on the screen upwards.
	Move the focus on the screen downwards.
Tapping the check box	Checks or unchecks the check box depending on the current status of the check box. Highlights the line.
Space bar	Starts the job search.

Description of metadata

Metadata	Description
-	The name of the job.

Metadata	Description
Source	The data storage device where the job is stored.
Date created	The date of when the job was created.

Dataset

The panel is similar to the panel that opens when **View & edit data** was selected from the job menu. Refer to "7.2 Accessing Data Management" for a description of the panel.

The differences are:

- All changes done in the data set are applied to the original jobs.
- For the key **New**: To create a point/line. New points/lines are stored in the main job and then displayed in the data set.
- For the metadata, **Source** is displayed. The linked job to which the point belongs.
- On the **3D viewer** page, the points and lines from the linked jobs are displayed. Selected filters for the data set points are applied.

The **Dataset** panel can also be accessed by a hot key or a favourites key.

6.3

Choosing a Job

Access

Select **Leica Captivate - Home:Tap here to choose design data.**

Design Data

The pages that are always shown are: **Points & lines** and **DTM**.

The pages, **Road**, **Rail** and **Tunnel** are only shown if the appropriate app is loaded.



The design data selected in this panel, are global design data. In the 3D viewer and when using the apps, the global design data will be overwritten by linked design data from the working job.

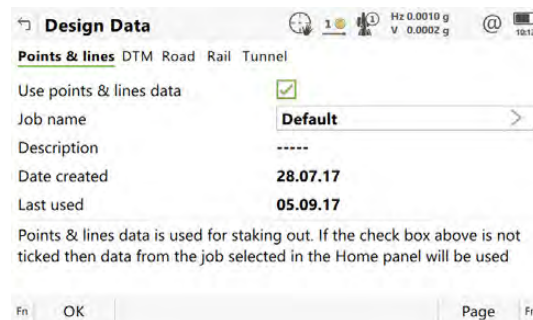

Key	Description
OK	To accept the selected job.
Page	To change to another page on this panel.
Fn Settings	To activate or deactivate job selection at the beginning of an app.

Description of fields

Field	Option	Description
Use points & lines data	Check box	When this box is checked, a separate design job can be selected. Target points can be selected from the design job. Individual lines and/or points of a separate design job can be staked out. The selected design job is visible in 3D viewer.
Name	Selectable list	Control points or lines are stored in the design job. The design job holds all control point information needed in the field, for example, control points, points with known coordinates used for a TS setup. Lines of the design job can be used for Stake to line or Measure to line . A CAD file attached to a design job can be used to view and import the CAD lines for working with.
Description	Display only	The detailed description of the job.
Date created	Display only	The date of when the job was created.
Last used	Display only	The date of when the job was last accessed.
Use a DTM	Check box	When this box is checked, a DTM job can be selected. A DTM job holds DTM (Digital Terrain Model) or TIN (Triangular Irregular Network) data. The files are stored in the \DBX folder or a subfolder of \DBX.
DTM	Selectable list	Holds DTM (D igital T errain M odel) data or TIN (T riangular I rrregular N etwork) data. The DTM job to be used must be stored in the \DBX directory on the active data storage device. The DTM job is a read-only source of information and cannot be selected as a job.  The selected DTM job is visible in the 3D viewer.
Layer	Display only or selectable list	A DTM job can consist of multiple DTM layers or surfaces. These DTM layers can cover different locations, be on top of each other or intersect each other. If there is only one layer in the DTM job, the layer name is displayed as an output. If there are multiple layers, the layer to display in 3D viewer can be selected.

Field	Option	Description
Use a road design	Check box	When this box is checked, a road design can be selected. Contains all the information about the road design. For example, the geometry of the line, the formation layer of the road or the information related to the construction of cuttings and embankments.
Road design	Selectable list	<p>The files are stored in the \DBX folder or a subfolder of \DBX.</p> <p>The data is either typed in manually in the Alignment editor app or converted from a road design package.</p> <p>The road job is a read-only source of information and cannot be selected as a job. The selected Road design is visible in 3D viewer.</p>
Use a rail design	Check box	When this box is checked, a rail job can be selected.
Rail design	Selectable list	<p>Contains all the information about the rail design including the geometry of the centre-line and the rail definition (superelevation). The files are stored in the \DBX folder or a subfolder of \DBX.</p> <p>The rail job is a read-only source of information and cannot be selected as a job. The selected Rail design is visible in 3D viewer.</p>
Use a tunnel design	Check box	When this box is checked, a tunnel job can be selected.
Tunnel design	Selectable list	<p>Contains all the information about the tunnel design including the geometry of the centre-line and the tunnel profile. The files are stored in the \DBX folder or a subfolder of \DBX.</p> <p>The tunnel job is a read-only source of information. The selected Tunnel design is visible in 3D viewer.</p>

Next step

Open the selectable list for jobs to view job metadata, data, create, edit or delete jobs.

**Choose Design Data,
DTM,
Road Design,
Rail Design,
Tunnel Design**

Listed are all jobs stored on the data storage device or in the internal memory depending on the device.



Key	Description
OK	To select the highlighted job and to return to the panel from where this panel was accessed.
New	Available for design jobs. To create a job. Refer to "6.2 Creating a New Job".
Edit	Available for design, Road, Rail and Tunnel jobs. To edit the highlighted job. Refer to "6.4 Editing a Job".
Delete	To delete the highlighted job, including all map files from attached CAD files.
Data	Available for design, Road, Rail and Tunnel jobs. To view, edit and delete points, lines, images and scans stored with the job. Points, lines, images and scans are shown on separate pages. Selected sort and filter settings apply. <div style="display: flex; align-items: flex-start;"> <div style="margin-right: 10px;">  </div> <div> <p>For Road, Rail or Tunnel jobs, review of the alignment design data, and edit the start chainage or centreline. A review of all design elements as well as a 3D viewer is available.</p> </div> </div>

6.4

Editing a Job

Description

In the **Job Properties:**, the settings for a job can be viewed and changed.

Access

From the job menu, select **View & edit job properties.**

**Job properties,
General page**

The fields on this page are identical with the fields in **New Job, General.** Refer to "6.2 Creating a New Job".

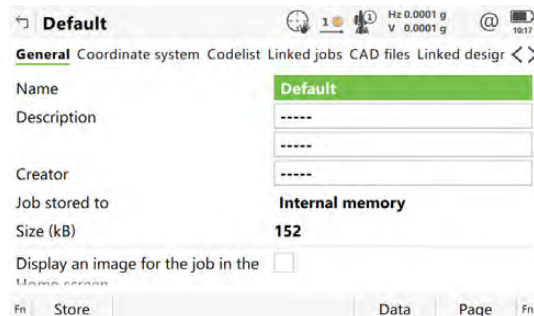

Key	Description
Store	To store the settings.
Data	To view, edit and delete points and lines stored with the job. Points and lines are shown on separate pages. Selected sort and filter settings apply.
Page	To change to another page on this panel.
Fn Log	To view, edit and delete points and lines stored with the job. Points and lines are sorted by time in one list.

Next step

Page changes to the **CAD files** page.

Refer to "New Job,Codelist page" for information on the **Coordinate system** page.

Job properties, Codelist page

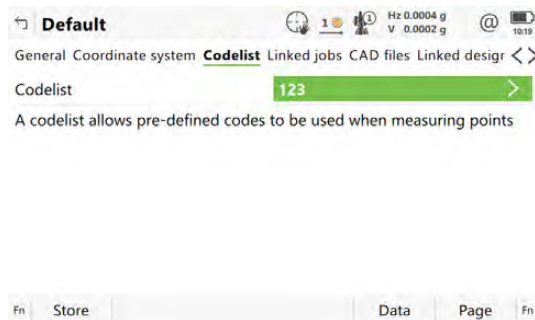

Key	Description
Store	To store the settings.
Import	To add extra codes from a new codelist to the job. The name of this codelist is copied to the job.
Codes	To view codes currently stored in the job. Refer to "6.5 Managing Job Codes".
Data	To view, edit and delete points and lines stored with the job. Points and lines are shown on separate pages. Selected sort and filter settings apply.
Page	To change to another page on this panel.
Fn Export	To copy codes from the job to an existing or new codelist.
Fn Log	To view, edit and delete points and lines stored with the job. Points and lines are sorted by time in one list.

Description of fields

Field	Option	Description
Codelist	<None>	No codes are stored in the job. This default setting can be changed. Choose a codelist to copy the codes to the job.

Field	Option	Description
	Display only	Codes are stored in the job. If codes had been copied from a codelist in the internal memory, the name of the codelist is displayed. If codes have been typed in, then the name of the job is displayed.

Next step

Page changes to the **Linked jobs** page.

Job properties, Linked jobs page

Multiple jobs can be linked to a working job. The advantage is, that the list of design points and lines available to be used in some applications can be read from these multiple linked jobs, instead of one single control job.

The source for a control job can be:

The source for a control job must be a job from Leica Captivate.

A external format, such as ASCII, XML or DXF must be converted into DBX format first.

Key	Description
Store	To store the settings.
Add	To link a control job to the job. Accesses Choose Linked Jobs . Refer to " Choose Linked Jobs".
Remove	To delete the highlighted control job from the list of linked jobs. The corresponding points and lines will be removed from the data set.
Dataset	To list all points and lines contained in the available and visible linked jobs. The list is updated with the data from the selected jobs to link. Refer to " Dataset".
Page	To change to another page on this panel.
Fn Main job	To make a linked job the main job where created points and lines are stored to.
Fn Log	To view, edit and delete points and lines stored with the job. Points and lines are sorted by time in one list.
Fn State	To change between the options in the metadata for State . To show or hide the linked job data within the data set.

Description of metadata

Metadata	Description
-	The name of the job.
State	The state of the job: <ul style="list-style-type: none"> • Visible: The data of the linked job are included in the data set. • Hidden: The data of the linked job are excluded from the data set. • Not available:The source job of the data is not available on any of the data storage devices.

Metadata	Description
Main Job	<p>Created control data such as points and lines are stored in the main job.</p> <p>To make a job the main job, highlight the job and press Fn Main job.</p> <p>As long as there is at least one available linked job, there must be a main job where the created points and lines are stored if created.</p> <p>If no linked job is available, for example all are deleted, or all are on an SD card which is not inserted, then there is no main job.</p> <p>If the main job is deleted, then the role of main job jumps to another linked job.</p> <p>if the main job is set as Hidden, the role of main job stays in that job.</p>
Source	<p>The data storage device where the job is stored.</p> <p>If the working job and/or linked jobs are moved to another device, the link between both is remembered.</p> <p>Source: ----- indicates that the source job of the data is not available in the expected data storage device.</p> <p>☞ If the data storage device containing one or more control jobs is taken out off the instrument, the jobs will NOT be available in the data set anymore.</p> <p>☞ Every time an app is started, the availability of control jobs is checked. The check ensures the correspondency between the list of linked jobs and the data set.</p>
Date created	The date of when the job was created.

Next step

Page changes to the **CAD files** page.

Job properties, CAD files page

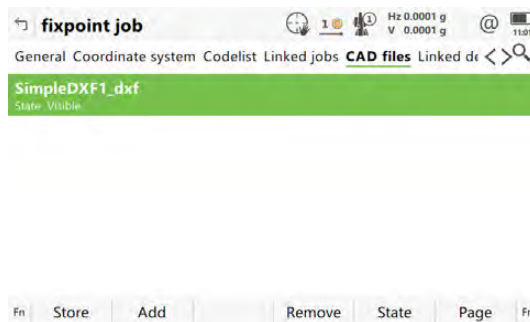

Key	Description
Store	To store the settings.
Add	To select a CAD file to be added to the job properties. The panel that opens is similar to New Job, CAD files page. Refer to "6.2 Creating a New Job" for a description of the panel.

Key	Description
	Only the files that are currently not attached to the job are displayed in the CAD Files panel. The files listed are all dxf, shp files and mpl files from the \Data directory on a data storage device or in the internal memory. If an mpl file is selected, then this file, including all related files, is copied to the appropriate job folder.
Remove	To delete the highlighted Map file from the job.  If deleted accidentally, the file must be attached again.
State	To show or hide the CAD data.
Page	To change to another page on this panel.
Fn Settings	To configure the CAD file import parameters. Refer to "CAD Import".
Fn Layers	To change to the CAD layers panel. On this panel, it is possible to make layers from the CAD file visible or hidden for 3D viewer.
Fn Log	To view, edit and delete points and lines stored with the job. Points and lines are sorted by time in one list.

Description of metadata

Metadata	Description
-	The name of the CAD files that can be used. The files displayed are the converted Leica Map files (*.mpl) within the job. The original file extension is added to the file name with an underscore, for example example_dxf.
State	If set to Visible , the CAD file is visible as background map in 3D viewer.

Next step

Press **Page** to change to the **Linked design data** page.

OR

Press **Fn Layers** to access **CAD Layer Management**.

OR

Press **Fn Settings** to access **CAD Import**.

 The design data selected in this panel, are local design data. In the 3D viewer and when using the apps. the global design data will be overwritten by linked design data from the working job.

Key	Description
Store	To store the settings.
Page	To change to another page on this panel.
Fn Log	To view logged data.

**Job properties,
Linked design data
page**

Description of fields

Field	Option	Description
Use a DTM	Check box	When this box is checked, a DTM job can be selected. A DTM job holds DTM (Digital Terrain Model) or TIN (Triangular Irregular Network) data. The files are stored in the \DBX folder or a subfolder of \DBX.
DTM	Selectable list	<p>Holds DTM (Digital Terrain Model) data or TIN (Triangular Irrregular Network) data. The DTM job to be used must be stored in the \DBX directory on the active data storage device.</p> <p>The DTM job is a read-only source of information and cannot be selected as a job.</p> <p> The selected DTM job is visible in the 3D viewer.</p>
Layer	Display only or selectable list	<p>A DTM job can consist of multiple DTM layers or surfaces. These DTM layers can cover different locations, be on top of each other or intersect each other.</p> <p>If there is only one layer in the DTM job, the layer name is displayed as an output. If there are multiple layers, the layer to display in 3D viewer can be selected.</p>
Date created	Display only	The date of when the job was created.
Use a road design	Check box	When this box is checked, a road design can be selected. Contains all the information about the road design. For example, the geometry of the line, the formation layer of the road or the information related to the construction of cuttings and embankments.
Road design	Selectable list	<p>The files are stored in the \DBX folder or a subfolder of \DBX.</p> <p>The data is either typed in manually in the Alignment editor app or converted from a road design package.</p> <p>The road job is a read-only source of information and cannot be selected as a job. The selected Road design is visible in 3D viewer.</p>
Use a rail design	Check box	When this box is checked, a rail job can be selected.
Rail design	Selectable list	Contains all the information about the rail design including the geometry of the centre-line and the rail definition (superelevation). The files are stored in the \DBX folder or a subfolder of \DBX.

Field	Option	Description
		The rail job is a read-only source of information and cannot be selected as a job. The selected Rail design is visible in 3D viewer.
Use a tunnel design	Check box	When this box is checked, a tunnel job can be selected.
Tunnel design	Selectable list	Contains all the information about the tunnel design including the geometry of the centre-line and the tunnel profile. The files are stored in the \DBX folder or a subfolder of \DBX. The tunnel job is a read-only source of information. The selected Tunnel design is visible in 3D viewer.

CAD Layer Management



Key	Description
Store	To store the settings.
State	To change between the options in the metadata for State .
All	To make all layers have the same state as the currently highlighted layer.

Description of metadata

Metadata	Description
-	The name of the layer. For dxf files, all layers are listed, no matter if the layer is filled or empty.

Metadata	Description
State	<p>The state of the layer:</p> <ul style="list-style-type: none"> • Hidden These layers are not shown on the 3D viewer page and their positions are not used when zooming to extents. Nothing in these layers can be selected. • Visible These layers are shown on the 3D viewer page and their positions are used when zooming to extents. Nothing in these layers can be selected. Empty dxf layers can be set to visible. • Selectable These layers are shown on the 3D viewer page and their positions are used when zooming to extents. Objects on these layers are available to be selected.

CAD Import

Description of fields

Field	Option	Description
Prefix to use for points, Prefix to use for lines or Prefix to use for closed lines	Editable field	The identifier with up to four characters is added in front of the ID of the imported CAD points, lines or areas.
Objects to create when importing entities	Vertices and lines	<ul style="list-style-type: none"> • Imports the CAD lines into the job. • Creates points at the starting and the ending coordinates of the imported line/arc/polyline elements.
	Only at vertices	Creates points at the starting and the ending coordinates of the line/arc/polyline elements. The elements are not imported.
	Only lines	Imports only the CAD lines into the job. No points are created.
Ignore data at height	Editable field	Height values inside the DXF file are considered invalid and are not converted.
Apply a height to 2D data	Check box	When this box is checked, a height can be defined which is then applied to all imported 2D CAD points.
Height to apply	Editable field	Available when Apply a height to 2D data is checked. The height to apply to 2D CAD points.

Field	Option	Description
Ignore the extents in the dxf file	Check box	When this box is checked then the values for the extents defined in the dxf file will be ignored. This may be necessary if these values are very large meaning that the data will not be displayed in the 3D viewer after importing or attaching the file. When this box is not checked then the values in the dxf file for the extents are used.

Choose Linked Jobs





All jobs on the available data storage devices are listed.

Select the jobs you want to link.

Check a box if you want to link the control job to the job.

Key	Description
OK	To return to New Job, Linked jobs page.

Check box behaviour

	Description
	Checks or unchecks the check box of the highlighted job. The behaviour depends on the current status of the check box.
	Checks or unchecks the check box of the highlighted job. The behaviour depends on the current status of the check box.
	Move the focus on the screen upwards.
	Move the focus on the screen downwards.
Tapping the check box	Checks or unchecks the check box depending on the current status of the check box. Highlights the line.
Space bar	Starts the job search.

Description of metadata

Metadata	Description
-	The name of the job.
Source	The data storage device where the job is stored.
Date created	The date of when the job was created.

Dataset

The panel is similar to the panel that opens when **View & edit data** was selected from the job menu. Refer to "7.2 Accessing Data Management" for a description of the panel.

The differences are:

- All changes done in the data set are applied to the original jobs.
- For the key **New**: To create a point/line. New points/lines are stored in the main job and then displayed in the data set.
- For the metadata, **Source** is displayed. The linked job to which the point belongs.
- On the **3D viewer** page, the points and lines from the linked jobs are displayed. Selected filters for the data set points are applied.

The **Dataset** panel can also be accessed by a hot key or a favourites key.

6.5

Managing Job Codes

Description

To view, edit, group and sort all codes currently stored in the job.

Access step-by-step

1. Select **View & edit job properties** from the job menu in **Leica Captivate - Home**.
2. **Page** until the **Codelist** page is active.
3. When creating a job: Open the selectable list for **Codelist**.
4. When editing a job: **Edit**
5. **Codes** to access **Job Codes**.

Job Codes

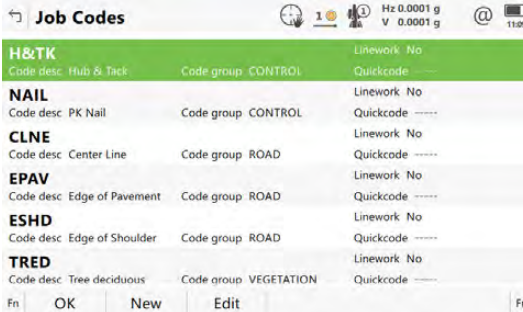

Code desc	Code group	Line work	Quickcode
H&TK Code desc: Hub & Tack	CONTROL	No	----
NAIL Code desc: PK Nail	CONTROL	No	----
CLNE Code desc: Center Line	ROAD	No	----
EPAV Code desc: Edge of Pavement	ROAD	No	----
ESHD Code desc: Edge of Shoulder	ROAD	No	----
TRED Code desc: Tree deciduous	VEGETATION	No	----

Key	Description
OK	To return to the previous panel.
New	To create a code. Refer to "8.4.2 Creating/Editing a Code".
Edit	To edit the highlighted code. Accesses Edit Code where new attributes can be added to a code and line styles can be changed.
Fn Group	To access Code Groups . To view, create, activate and deactivate code groups. Refer to "8.5 Managing Code Groups".
Fn Sort	To access Sort Codes . To sort codes by code name, code description, quick code or last used.

Next step

Edit to edit an existing job code.

Edit Code

← Edit Code

Code H&TK

Code description Hub & Tack

Code group CONTROL

Code type Point

Linework

Store New attrb

Key	Description
Store	To store the code including any newly created attributes.
New attrb	To add an attribute to a code.

The behaviour of this panel varies with the type of code to be edited.

When creating a job, more code metadata are editable. When editing a job, less code metadata are editable.

The differences are explained in the table.

Type of code	Description
Point codes	<ul style="list-style-type: none">New attributes can be added with New attrb.For new jobs: The line style, line colour and string number can be changed. These selections are stored to the code.
Free codes	New attributes can be added with New attrb .

For attributes for which an attribute name can be typed in:

Tap on the field of the attribute name or the field for the attribute value. The name of the attribute can be edited and an attribute value can be typed in.

7 Job Menu - View & edit data

7.1 Overview

Description

Data management is the administration of data stored in the job, including

- viewing data and related information.
- editing data.
- creating new data.
- deleting existing data.
- filtering existing data.

7.2 Accessing Data Management

Access

Select **View & edit data** from the job menu.





The objects listed on the pages belong to the edited job. The objects listed and their order depend on the active sort and filter settings. Refer to "7.6 Point Sorting and Filters" for information about sort and filter settings.

Job name, Points page

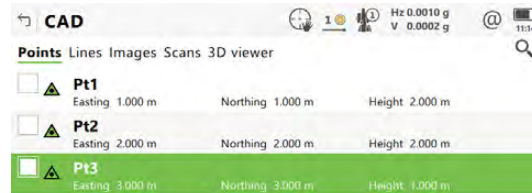



Check one or multiple points for editing. Use **Fn All** to select all points at once.



Key	Description
OK	To close the panel and return to the panel from where this panel was accessed.
New	To create a point.
Edit	To edit the highlighted point. In case of multiple point selection, editing the target height for all selected points is possible.  Editing the target height for multiple points is possible for TS points of class Measured, Adjusted and None .
Delete	To delete the highlighted point. In case of multiple point selection, all selected points are deleted.
More	To display information about the codes and code information if stored with any point, the 3D coordinate quality, the class, Easting, Northing and Elevation, the time and the date of when the point was stored.







Key	Description
	The order in which the Easting and Northing columns are shown depends on the Grid format configured to be used in Regional, Coordinates page.
	The Easting, Northing and Elevation values are shown in the unit configured in Regional, Distance page.
Page	To change to another page on this panel.
FnLog	To view points, lines and free codes stored with the job sorted by time. Refer to "7.5 Data Log".
Fn Filter	To define sort and filter settings. Refer to "7.6 Point Sorting and Filters".
Fn All or Fn None	To select or deselect all points at once.

Check box behaviour

Action	Description
	Checks or unchecks the check box of the highlighted point. The behaviour depends on the current status of the check box.
	Checks or unchecks the check box of the highlighted point. The behaviour depends on the current status of the check box.
	Move the focus on the screen upwards.
	Move the focus on the screen downwards.
Tapping the check box	Checks or unchecks the check box depending on the current status of the check box. Highlights the line.
Tapping the image linked to the point	Enlarges the images. Highlights the line.
Space bar	Starts the point search.

Description of symbols

The symbols match the symbols in the 3D viewer.

Symbol	Description
	Point of class Control (Ctrl) with full coordinate triplet
	Point of class Adjusted (Adj) or Average (Avge)
	Point of class Reference (Ref)
	Point of class Measured (Meas)
	Single Point Position uploaded from Infinity Point of class Navigated (Nav) or Estimated (Est)
	Point measured within a Stake app

Next step

Page changes to the **Lines** page.

Job name,
Lines page

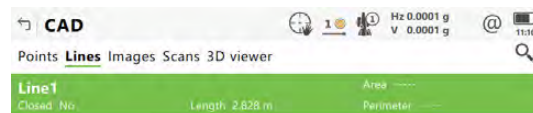

Fn OK New Edit Delete More Page Fn

Key	Description
OK	To close the panel and return to the panel from where this panel was accessed.
New	To create a line. After storing the new line, all existing lines which are open are closed. Refer to "7.4.2 Creating a New Line".
Edit	To edit the highlighted line.
Delete	To delete the highlighted line.

Key	Description
More	To display information about the codes if stored with any line, the start time, the end time of when the last point was added to the line, the length of the line, the perimeter and the area.
Page	To change to another page on this panel.
Fn Filter	To define sort and filter settings. Refer to "7.6 Point Sorting and Filters".

Description of metadata

Metadata	Description
-	The listed lines already stored in the job.
Closed	The status of a line. If a line is closed, it means that it is physically closed onto itself, effectively becoming an area.

Next step

Page until the **3D viewer** page is active.



For information on camera and images refer to "32.4 Image Management".

Job name, Scans page

Check one or multiple scans for a perspective display of the 3D point clouds in the **3D viewer**. Use **Fn All** to select all scans at once.

Key	Description
OK	To close the panel and return to the panel from where this panel was accessed.
Page	To change to another page on this panel.
Fn Delete	To delete the highlighted scan.
Fn All or Fn None	To select or deselect all scans at once.

Description of metadata

Information about the date, the time, the status and the number points.

7.3

Point Management

7.3.1

Creating a New Point

Access

In **Job name, Points** page, press **New**.

New Point, Coordinates page

New Point

Coordinates Code Images

Point ID: Pt4

Easting: 10.000 m

Northing: 10.000 m

Height: 10.000 m

Fn Store Page Fn

Key	Description
Store	To store the new point entered and all associated information.
North or South	Available for local geodetic or WGS 1984 geodetic coordinates when WGS84 latitude is highlighted. Changes between North and South latitude.
East or West	Available for local geodetic or WGS 1984 geodetic coordinates when WGS84 longitude is highlighted. Changes between East and West longitude.
Next	To store the point and to remain in the panel. The point ID increments according to point ID template.
Page	To change to another page on this panel.
Fn Coord	To view other coordinate properties.
Fn Tools	For an individual name independent of the ID template or to change back to the next ID from the configured ID template.

Description of fields

Field	Option	Description
Point ID	Editable field	The name of the new point. The configured point ID template is used. The ID can be changed in the following ways: <ul style="list-style-type: none"> To start a new sequence of point IDs, type over the point ID. For an individual name independent of the ID template Fn Tools and then Individual point ID. Fn Tools and then Sequential point ID changes back to the next ID from the configured ID template.
Coordinate fields	Editable field	Negative geodetic coordinates are interpreted as being of the opposite hemisphere or other side of the central meridian. For example, entering -25 °N is stored as 25 °S, entering -33 °E is stored as 33 °W.

Next step

Page changes to the **Code** page.

New Point, Code page

The settings for **Code & attributes** in **Leica Captivate - Home: Settings \Customisation\Coding** determine the availability of the subsequent fields and softkeys.

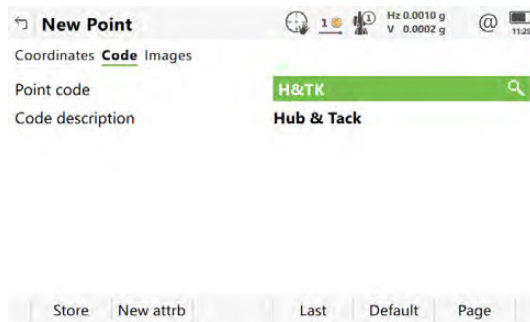

Key	Description
Store	To store the new point entered and all associated information.
New attrb	To create more attributes for this point code.
Last	To recall the last used attribute values which were stored with this point code.
Default	To recall the default attribute values for the selected code.
Page	To change to another page on this panel.

Description of fields

Field	Option	Description
Point code	Selectable list	The codes from the job codelist are used. All point codes of the job codelist can be selected. The description of the code is shown as a display only field. The attributes are shown as display only, editable fields or selectable lists depending on their definition.
	Editable field	Codes for points can be typed in. A check is performed to see if a point code of this name exists in the job. If so, an information message is displayed. If Suggested attribute values: Last used in Coding , the attributes are also shown.
Attribute	Editable field	Up to 20 attribute values are available.

Next step

Store stores the new point entered and all associated information.

The properties stored with the point are:

- Class: **Control**
- Sub class: **Fixed (Pos & Ht)**
- Source: **User entered**
- Instrument source: **GS**



It may happen that a point with the same point ID exists in the job. If the codes and/or attribute values of the new and the existing point do not match, a panel opens where they can be corrected.

7.3.2

Editing a Point

Access

In **Job name, Points** page, press **Edit**.



If multiple points are selected when **Edit** is pressed, only the target height is editable. Editing the target height for multiple points is possible for TS points of class **Measured**, **Adjusted** and **None**.

Point ID, Coordinates page

The visible pages on this panel depend on the properties of the point being edited.

It is possible to edit the point ID and for points of **Class: Control** and **Class: Estimated** also the coordinates. Other point-related data is shown in display only fields.



Changing the point ID of a point, applies this new point ID to all other points with the same original name, regardless of their class.



Points of **Class: Reference** cannot be renamed.



Changing coordinates of a point which has been previously used in other apps, for example COGO, or hidden point measurements does not update the app results.



An edited point retains the creation value for **Time**.

Pt3 Hz 0.0004 g V 0.0002 g 11:27

Coordinates Code Images

Point ID	Pt3
Easting	3.000 m
Northing	3.000 m
Height	1.000 m
Time	11:13:25
Date	11.09.17

Fn Store Previous More Page Fn

Key	Description
Store	To store the changes.
Previous	To display the previous point in the list of points displayed in Job name, Points page. Available unless the beginning of the list is reached.
Next	To display the next point in the list of points displayed in Job name, Points page. Available unless the end of the list is reached.
More	To display information about class, sub class, 3D coordinate quality, time and date of when point was stored, instrument source, source and the flag for Linework if available.
Page	To change to another page on this panel.
Fn Coord	To view other coordinate properties.

Key	Description
Fn Ell Ht or Fn Height	Available for local coordinates. Changes between the ellipsoidal and the orthometric height. Changing the height type does not edit the point.

Next step

Page changes to the next page.

Point ID, Stake results page

On this page, the stakeout results are displayed.



When changing **Target height** on the **Obs** page, the **Measured height** value is updated. The offset values used for staking the point will not be editable on the **Offset** page.

Key	Description
Store	To store the changes.
Page	To change to another page on this panel.

Description of fields

Field	Option	Description
Design point ID	Display only	The name of the design point that was staked.
Difference in easting	Display only	The difference between the Design easting and the Measured easting .
Difference in northing	Display only	The difference between the Design northing and the Measured northing .
Cut/Fill	Display only	The height difference between the Design height and the Measured height .
2D distance	Display only	Displays the horizontal difference between the design point and the staked point.
3D distance	Display only	Displays the spatial difference between the design point and the staked point.
Design easting	Display only	The entered design Easting.
Design northing	Display only	The entered design Northing.
Design height	Display only	The entered design elevation.
Measured easting	Display only	The Easting measured at the stored point.
Measured northing	Display only	The Northing measured at the stored point.
Measured height	Display only	The height measured at the stored point.

Next step

Page changes to the next page.

Point ID,
Obs page

Available when the edited point is **Class: Measured**.

For GS points

The name of the real-time base station from where the GNSS point was measured, the name of antenna used to measure the point and the baseline values, are shown in display only/observations fields.

For TS point

It is possible to edit the reflector height. The name of the setup from where the point was measured is shown in a display only field.

 Changing the reflector height recalculates the point height. The values for **Cut** and **Fill** in **Stake results** page are also updated.

The distance variables **Difference in Hz angle**, **Difference in V angle**, **Difference in slope distance** are shown in a display only field, whenever a measurement has been taken in both faces.

More displays the horizontal angle or the azimuth from the point to the instrument.

For TS points measured with Measure Foresight

Listed are the setup ID, the backsight point, the set number and the average measurement values.

 Press **Sets** to include or exclude measured sets in the calculation of a foresight point.

Next step

Page changes to the next page.

Point ID,
Offset page

Available when the edited point was measured with offsets using TS.

Check and change, if required, the entered offset values. When an offset values has been changed, the coordinates for the stored point will be updated.

Key	Description
Store	To store the changes.
Page	To change to another page on this panel.

Description of fields

Field	Option	Description
Offset left/ right		The cross offset of the target point, perpendicular to the line of sight.
	Display only	For staked points.

Field	Option	Description
	Editable field	For measured points.
Offset in/out		The length offset of the target point, in the direction of the line of sight.
	Display only	For staked points.
	Editable field	For measured points.
Offset height		The height offset of target point.
	Display only	For staked points.
	Editable field	For measured points.
Easting	Display only	The Easting measured at the stored point. Offset applied. Updated, if offset has been edited.
Northing	Display only	The Northing measured at the stored point. Offset applied. Updated, if offset has been edited.
Height	Display only	The height measured at the stored point. Offset applied. Updated, if offset has been edited.

Next step

Page changes to the next page.

Point ID, RTK info page

Available for GNSS points which were recorded in real-time mode, however not for average or mean points.

All fields are display only fields and cannot be edited.

The information is obtained from **Settings** and data coming across with the real-time information and the Ntrip connection.

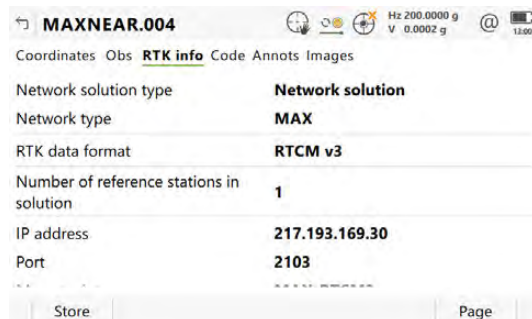

Description of fields

Field	Option	Description
Network solution	Single base-line	Displayed when Use RTK network is not checked in RTK Rover Settings , RTK network page.

Field	Option	Description
	Network solution	Displayed when Use RTK network is checked in RTK Rover Settings, RTK network page.
Network type	FKP, VRS, MAX, i-MAX	The type of reference network selected in RTK Rover Settings . Refer to "RTK Rover Settings,RTK network page".
	Nearest	If Network type: Nearest is selected in RTK Rover Settings , a singlebase solution is calculated and the number of base stations equals 1.
RTK data format	Display only	Refer to "RTK Rover Settings,General page".
Number of reference stations in solution	Display only	<ul style="list-style-type: none"> For single-baseline solutions, this number is always 1.
		<ul style="list-style-type: none"> For VRS and i-MAX, this number is always 1 since it is not possible to derive the number of base stations contributing to the VRS or i-MAX corrections from the data format.
		<ul style="list-style-type: none"> For network solutions, this information is derived from the content of the data format. Only RTCM v3 and Leica 4G are able to provide this number.
Mountpoint	Display only	<p>The name of the correction data stream that was selected from the source table received in the TCP/IP port. Available for network RTK with Ntrip.</p> <p>The information is available for all Ntrip connections independent from the Network type used. The information is derived from the Connection Settings, either manually defined or selected from the NTRIP Source Table.</p>
Point measured inside network	Display only	Available for network RTK with Ntrip and MAX and data format RTCM v3 or Leica 4G .
User ID	Display only	Available for single baseline RTK, network RTK with/without Ntrip.

Next step

Page changes to the next page.

Point ID, Elevations page

On this page, multiple elevations which have been stored with a staked point can be edited. Additional multiple elevations can be entered.

Refer to "Stake Results,Elevations page" for more information on multiple elevations.

Key	Description
OK	To store the changes.
Page	To change to another page on this panel.

Description of fields

Field	Option	Description
Elevation	Editable field	The entered elevation is stored with the point and used to calculate the cut and fill values.
Cut/Fill	Display only	<p>Height of the point being stored – Entered elevation ----- = Cut or fill value (always positive)</p> <p>Examples For cut: Height of the point being stored – Entered elevation ----- Result > 0</p> <p>598.5672 m – 596.4856 m = 2.0816 m = cut The displayed value is 2.0816 m.</p> <p>For fill: Height of the point being stored – Entered elevation ----- Result < 0</p> <p>598.5672 m – 599.7826 m = -1.2154 m = fill The displayed value is 1.2154 m.</p>
Information	Editable field	<p>Additional information that must be stored with the elevation. Only the entered Information which also has an entered elevation is stored to the point being stored.</p>

Next step

Page changes to the next page.

Point ID, Code page

Available when the edited point is **Class: Measured**.

The point code and code information can be edited. All point codes in the job can be selected.

The description of the code is shown as a display only field.

The attributes are shown as display only, editable fields or selectable lists depending on their definition.

The attribute values shown depend on the setting in **Coding. Suggested attribute values: Last used** shows the last used attribute values which are

stored for this point code in the active codelist. **Suggested attribute values:** **Default** shows the default attribute values for this point code if existing.



It may happen that a point with the same point ID exists in the job. If the codes and/or attribute values of the new and the existing point do not match, a panel opens where they can be corrected.

Next step

Page changes to the next page.

Point ID, Annots page

Available when the edited point is **Class: Navigated** or **Class: Measured** and no offset point.

The comments to be stored with the point can be edited.

Next step

Page changes to the next page.

Point ID, Mean page

Available when the edited point is **Class: Average**.

Refer to "7.3.3 Mean Page" for a detailed description.

7.3.3

Mean Page

Description

In order to check measurements, the same point can be measured more than once.

These measured points are assigned the class **Measured**. The various measured coordinate triplets for one point can be recorded using the same point ID. If the **Duplicate points** mode is activated, an average is calculated when more than one measured coordinate triplet is available for the same point ID.

The averaged point is given the class **Average**. It is checked if the deviations of each single point are within the limits configured in **Duplicate Points**.

After averaging, the **Mean** page becomes available when editing the point and accessible from the Measure app. Available functionality on the **Mean** page depends on the selected **Duplicate points** mode.

Averaging

Defining the mode and configuring the limits

The mode and the limits are configured in **Duplicate Points**.

Description of modes

Mode	Description
Check the average	When more than one measured coordinate triplet is recorded for the same point, the average for the position and the height is computed. Depending on the selected method, the average is computed weighted or arithmetic (no weighting). The class Average is assigned to the averaged point.

Mode	Description
	The horizontal and height distances from the measured points to the average are computed and displayed on the Mean page. A check is performed that the differences in position and height, between the averaged point and the point being stored, do not exceed the defined limits.
Check the abs diff	What is described for Don't check also applies for Absolute differences . Additionally, the absolute difference between two points selected from a list of measured points with the same point ID, is checked to be within the defined limits.
Don't check	Averaging functionality is turned off. With more than one measured coordinate triplet recorded for the same point, no average for the position and the height is computed.

Averaging with position only or height only points

Position only points, height only points and points with full coordinate triplets are handled in the averaging.

Access step-by-step

The **Mean** page can be accessed if

When a point is stored with same point ID as existing point: Check the average or **When a point is stored with same point ID as existing point: Check the abs diff** is configured in **Duplicate Points**.

AND

more than one measured coordinate triplet is recorded for the same point using the same point ID.

1. In **Job name, Points** page, highlight a point to be edited.
2. **Edit** to access **Job name, Mean** page.

Point ID, Mean page

All measured coordinate triplets recorded using the same point ID are shown.

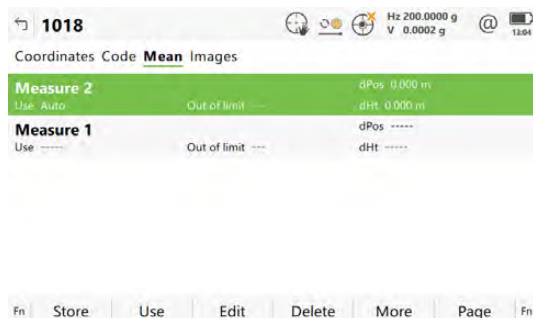

Key	Description
Store	To store the changes.
Use	To change between the options in Use metadata for the highlighted coordinate triplet. To include or exclude this triplet in or from the calculation of the average.

Key	Description
Edit	To view and edit the highlighted measured coordinate triplet. It is possible to edit the point ID and the antenna height without impact on all other classes of the point with the same original name. The coordinates are updated. A change in codes must be an overall change for the average point. Example: One of the measured coordinate triplets has a wrong point ID and should not be included in the average. By editing the point ID, the point is renamed and no longer contributes to the average.
Delete	To delete the highlighted coordinate triplet. The average is recomputed.
More	To change between time and date of when the point was stored and the 3D coordinate quality.
Page	To change to another page on this panel.
Fn Diff	Available for When a point is stored with same point ID as existing point: Check the abs diff and Yes for the Use metadata for exactly two measurements. To display the absolute coordinate differences when a local coordinate system is active. Differences exceeding the defined limit are indicated by !.

Description of metadata

Metadata	Description
Use	<p>The use of a measured coordinate triplet in the averaging.</p> <ul style="list-style-type: none"> • Auto The coordinate triplet is included in the averaging computation if within the averaging limit defined. • Yes The coordinate triplet is always included in the averaging computation even if it would fall outside the averaging limit defined. • No The coordinate triplet is never included in the averaging computation. • ----- The coordinate triplet cannot be included in the averaging computation. Automatically set by the system. <p>Use changes between the options.</p>
Time	The time the measured coordinate triplet was stored.
Date	The date the measured coordinate triplet was stored. The format is as defined in Regional, Time page.
dPos	The horizontal distance from the measured coordinate triplet to the average. dPos: ----- indicates unavailable information, for example for a height only point.
dHt	The height distance from the measured coordinate triplet to the average. dHt: ----- indicates unavailable information, for example for a position only point.

Metadata	Description
Out of limit	Available for measured coordinate triplets with Auto or Yes in the Use metadata if When a point is stored with same point ID as existing point: Check the average . Indicates an exceeding of the limits.

Next step

Store stores the changes.

7.4

Line Management

7.4.1

Overview

Description

A line consists of points and can be created/edited. The individual points are measured within any app. All points can be used except auxiliary points. Points can be simultaneously assigned to one or more lines.

7.4.2

Creating a New Line

Access

In **Job name, Lines** page, press **New**.

New Line, General page

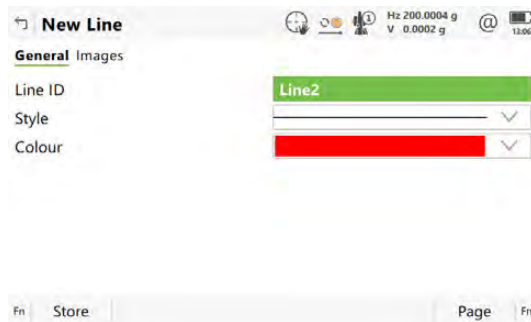

Key	Description
Store	To store the new line entered and all associated information.
Page	To change to another page on this panel.
Fn Indiv ID or Fn Run	For an individual name independent of the ID template or to change back to the next ID from the configured ID template.

Description of fields

Field	Option	Description
Line ID	Editable field	The name of the new line. The configured ID template for lines is used. The ID can be changed in the following ways: <ul style="list-style-type: none"> To start a new sequence of line IDs, type over the line ID. For an individual name independent of the ID template Fn Indiv ID. Fn Run changes back to the next ID from the configured ID template.

Field	Option	Description
Style	Selectable list	The line style in which lines are represented in 3D viewer and Infinity.
Colour	Selectable list	A colour in which the line is displayed.

Next step

Page changes to the **Geometry** page.

New Line, Images page

Images are displayed as thumbnail images in a list, together with the image name. Attach one or more images to the line.

Key	Description
Store	To store the changes and update the line.
New	To take an image.
Page	To change to another page on this panel.

Description of metadata

Information about the image size and the time and the date of when the image was stored.

Next step

Page changes to another page on this panel.

Creating lines most efficiently

To create lines with certain codes use quick coding. The job codelist must contain quick codes for lines. By typing the quick code a new line is created and immediately stored with that line code and attributes. For the line ID, the line ID template as defined in **ID Templates** is used.

7.4.3

Editing a Line



Access

In **Job name, Lines** page, press **Edit**.

Line ID, General page

Key	Description
Store	To store the changes.
More	To display End time and End date .
Page	To change to another page on this panel.

Description of fields

Field	Option	Description
Line ID	Editable field	The name of the line can be edited.  A line cannot be renamed to an existing line ID.
Style	Editable field	The line style in which lines are represented in 3D viewer and Infinity.
Colour	Editable field	A colour in which the line is displayed.
Number of points	Display only	The number of points contained within the line.
Length	Display only	The sum of the distances between the points in the sequential order in which they are stored for the line. This length can be a horizontal grid distance or a geodetic distance on the WGS 1984 ellipsoid.
Start date and Start time	Display only	The time/date when the line was created.  An edited line retains the creation value for Start time .
End date and End time	Display only	The time/date when the last point was added to the line. This can be different to the time the point was created. The values do not change after deleting the last added point or after editing unless an extra point is added to the line.

Next step

Page changes to the **Geometry** page.

Line ID, Geometry page

Listed is the geometry of the nodes that make up the line object. The order corresponds the position of the nodes along the line.

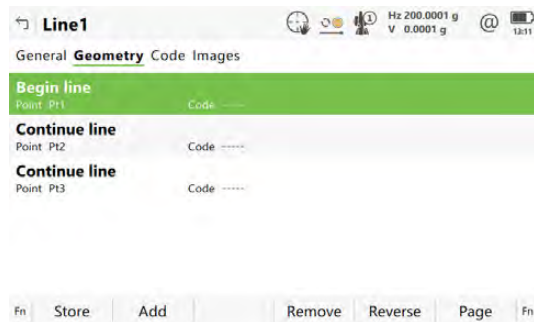

Key	Description
Store	To store the changes and update the line.
Add	To add a node below the highlighted node.
Edit	To edit the highlighted node, including the linework operation.
Delete	To remove the highlighted node.

Key	Description
Reverse	To reverse the order of the nodes and their geometry.
Page	To change to another page on this panel.

Next step

IF	THEN
Allow lines to be coded independently of points is checked in Coding, Code & attributes page	Page changes to the Code page.
Allow lines to be coded independently of points is not checked in Coding, Code & attributes page	Page changes to the Images page.

Line ID, Code page

Available when **Allow lines to be coded independently of points** is checked in **Coding, Code & attributes** page.

Key	Description
Store	To store the changes and update the line.
New attrb	To add an attribute of type normal and of value type text. Up to twenty attributes can be added. Attributes of type mandatory or fixed and of value type real or integer must be created in Infinity.
Last	Available if a code has been previously used in the job. To select from a list of last used codes. The codes are sorted by time with the most recently used code at the top of the list.
Default	To recall the default attribute values for the selected code.
Page	To change to another page on this panel.

Description of fields

Field	Option	Description
Line ID	Editable field	The name of the line can be edited.  A line cannot be renamed to an existing line ID.
Line code	Selectable list or editable field	The line code to be stored with the point. Depending on the setting for Allow new codes to be created in Coding, Code & attributes page, the field is a simple list or a selectable list and an editable field at the same time.
Code description	Display only	A description of the code.

Next step

Page changes to the **Images** page.

Line ID, Images page

The list shows all images linked to the line. Each image has a thumbnail image and an image name.

Key	Description
Store	To store the changes and update the line.
Sketch	To sketch over an image taken with a camera.
Delete	To delete the highlighted image.
Page	To change to another page on this panel.
Fn Unlink	To remove the link from the image to the line.

Next step

Page changes to another page on this panel.

7.5

Data Log

Description

A list of all objects and free codes in the job is displayed in order of time.

Access step-by-step

Access within data management

In **Job name**, **Points** page, press **Fn Log**.

Access within job management

In **Job name**, **General** page, press **Fn Log**.

Data log

All points, lines and free codes stored within the job are displayed. They are always sorted by time with the most recent record at the top. For lines, the value for **Start time** is relevant.

Time	Date	Code	Record type
20:17:13	06.03.2006	FNCM	Point
20:17:04	06.03.2006	----	Point
20:16:52	06.03.2006	FNCM	Point
20:16:41	06.03.2006	FNCM	Point
20:16:31	06.03.2006	----	Point

Key	Description
OK	To close the panel.
New	To insert a free code below/before the currently highlighted object or record. The functionality of inserting a free code is identical to the functionality of entering a free code during a survey.
Edit	To edit the highlighted object or free code. The functionality of editing a free code is identical to the functionality of entering a free code during a survey. Refer to "27.4 Free Coding".
Delete	To delete the highlighted object or free code.

Description of metadata

Information about the type of data recorded, the time and the date of when it was stored or for lines when they were created and the codes if stored with any object.

7.6 Point Sorting and Filters

7.6.1 Sorting and Filters for Points and Lines

Description

The sort settings define the order of the objects in the job. The filter settings define the objects to be viewed.

Two types of filters are available:

Type	Description
Point filter:	An active point filter shows selected points in Job name, Points page.
Line filter:	An active line filter shows selected lines in Job name, Lines page.



For information on camera and images refer to "32.4 Image Management".



The sort and filter settings are stored in the job. They are remembered after turning off the instrument.

When a job becomes active, then the sort and filter settings of this job are saved in the internal memory. If the data storage device is formatted then these last used sort and filter settings are used for the default job.

When a new job is created, the sort and filter settings from what was the job are copied to the new job.



Changing the job influences the sort and filter settings for the objects. The settings are changed to those of the selected job.

Access

On the **Points** or **Lines**, press **Fn Filter** to access **Sort & Filter**.

Sort & Filter, Points page

The available fields on this panel depend on the selected setting for **Filter to show**.

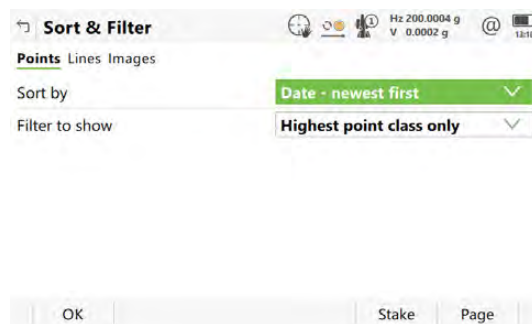

Key	Description
OK	To close the panel and return to the panel from where this panel was accessed. The selected sort and filter settings are applied.
Codes	Available for Filter to show: Points with certain codes . To define the code filters. Refer to "7.6.2 Point Code Filter".
Stake	To filter points for the Stake app. Refer to "7.6.3 Stakeout Filter".
Page	To change to another page on this panel.

Description of fields

Field	Option	Description
Sort by	Point ID - ascending, Point ID - descending, Date - oldest first or Date - newest first	Always available. The method points are sorted by.
	Filter to show	Always available. The method the points are filtered by.
	All	Shows all points.
	Highest point class only	Shows points of highest class.
	Range of point IDs	Shows points with point IDs between the entered start and end ID. The points are left aligned and sorted by the first digit.
	Pt IDs matching wildcard	Shows points with point IDs matching the wildcard.
	Time	Shows points which were recorded within a defined time window.
	Certain point classes only	Shows points of the selected class.
	Pts created by instrument	Shows points originating from the selected instrument or software program type.
	Points with certain codes	Shows points with selected codes attached.
	Multiple point ID ranges	Available when the Sort & Filter panel was accessed from the Dataset panel. Shows points with point IDs between several entered start and end ID.
Start ID	Editable field	Available for Filter to show: Range of point IDs . The first point to be displayed.

Field	Option	Description
End ID	Editable field	Available for Filter to show: Range of point IDs . The last point to be displayed.
Wildcard	Editable field	Available for Filter to show: Pt IDs matching wildcard . * and ? are supported. * indicates an undefined number of unknown characters. ? indicates a single unknown character.
Start date	Editable field	Available for Filter to show: Time . The date of the first point to be displayed.
Start time	Editable field	Available for Filter to show: Time . The time of the first point to be displayed.
End date	Editable field	Available for Filter to show: Time . The date of the last point to be displayed.
End time	Editable field	Available for Filter to show: Time . The time of the last point to be displayed.
Control (Ctrl), Adjusted (Adj), Reference (Ref), Measured (Meas), Navigated (Nav), Estimated (Est), None	Show or Hide	Available for Filter to show: Certain point classes only . Defined classes are shown or hidden.
View		Available for Filter to show: Certain point classes only .
	Highest triplet	The coordinate triplets of the highest class are shown.
	All triplets	All classes for one coordinate triplet are shown.
Instrument	All, TS, GS, Office, Level, Controller, Third party SW or Unknown	Available for Filter to show: Pts created by instrument . Points originating from this instrument type are shown.
List of ranges	Editable field	Available for Filter to show: Multiple point ID ranges . Enter the first and the last point of a range to be displayed. Single point entry is valid. <ul style="list-style-type: none"> • ,: Separates the ranges. • -: Separates the first and the last point of a range <p>Example: 1-20,25,30-40</p>

Next step

Page changes to the **Lines** page.

Sort & Filter, Lines page

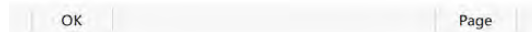
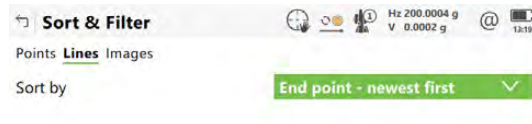

Key	Description
OK	To close the panel and return to the panel from where this panel was accessed. The selected sort and filter settings are applied.
Page	To change to another page on this panel.

Description of fields

Field	Option	Description
Sort by	Line ID - ascending, Line ID - descending, Start point - oldest first, Start point - newest first, End point - oldest first, End point - newest first	Always available. The method the lines are sorted by.

Next step

OK closes the panel.

7.6.2

Point Code Filter

Access step-by-step

1. In **Sort & Filter** select **Filter to show: Points with certain codes.**
2. **Codes** to access **Point Code Filter.**

Point Code Filter

This panel shows the point codes from the job and codes currently used as filter. Point codes are sorted according to the settings in **Sort Codes**.

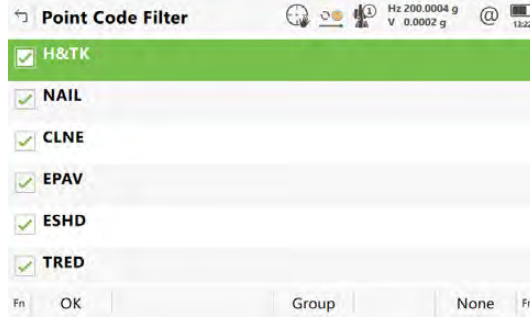

Key	Description
OK	To close the panel and return to the panel from where this panel was accessed.
Group	To activate and deactivate code groups. Accesses Code Groups . Any code group that has been previously deactivated are displayed as deactivated here. Codes belonging to a deactivated code group are not displayed in Point Code Filter .
Use	To activate and deactivate the filter for the highlighted code.
None or All	To deactivate or activate all point codes.
Fn Sort	To define the order of the codes. Accesses Sort Codes .

7.6.3

Stakeout Filter

Description

The settings on this panel define a filter for the Stake app. The Stake filter can be applied to show points which are already staked or points that are still to be staked.



The stakeout filter acts in addition to any other filter set in **Sort & Filter**. For example, points still to be staked out with a particular code can be filtered.

Access

In **Sort & Filter, Points** page, press **Stake** to access **Stakeout Filter**.

Stakeout Filter

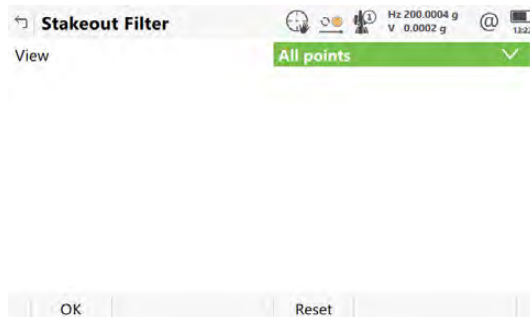

Key	Description
OK	To close the panel and return to the panel from where this panel was accessed.
Reset	To reset the staked flag for all points of the currently job.

Description of fields

Field	Option	Description
View	All points	Shows all points.
	Points to stake	Shows points not yet staked out.
	Staked points	Shows points which are already staked out.

8

Codelists

8.1

Overview



It is recommended to create a codelist in Infinity. A codelist can be transferred from Infinity to the internal memory of the instrument using the data storage device.

Steps from creating to using a codelist

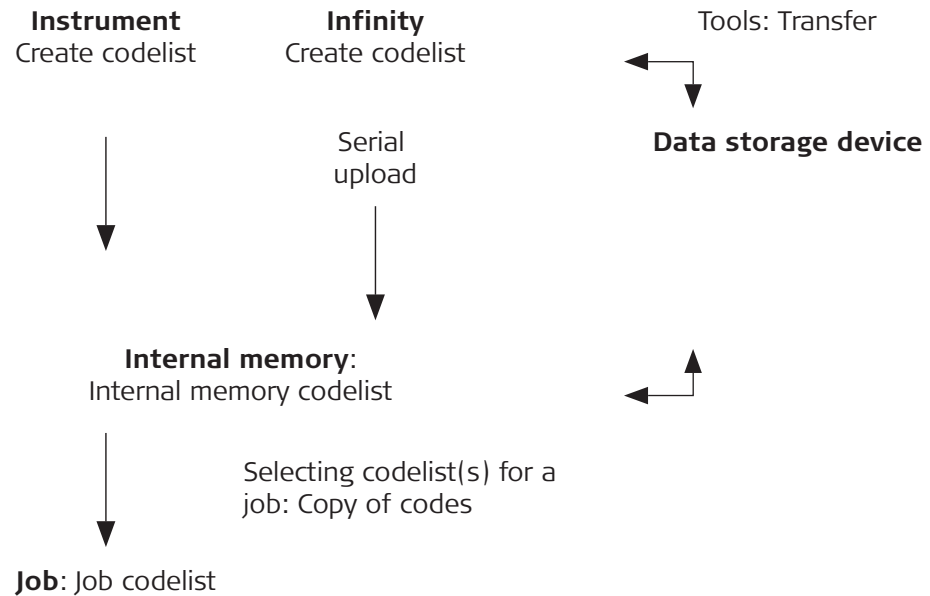

The creating, editing and managing of codelists is explained in this chapter. In order to use a codelist on the instrument, it must be transferred from the data storage device to the internal memory.

8.2

Accessing Codelist Management

Access

1. Select **Tap here to create new job** from the job menu in **Leica Captivate - Home**.
2. Go to the **Codelist** page.
3. Open the selectable list for **Codelist**.

Codelists

Listed are all codelists stored in the internal memory.

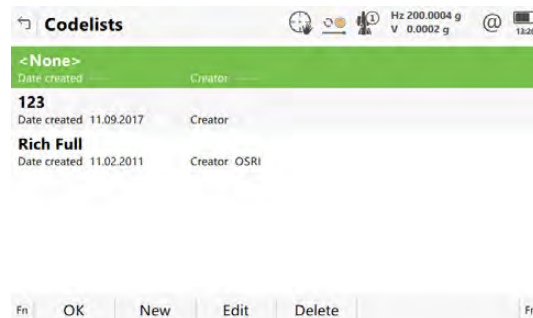

Key	Description
OK	To return to the panel from where this panel was accessed. The codes from the highlighted codelist are copied to the job.
New	To create a codelist. Refer to "8.3 Creating/Editing a Codelist".
Edit	To edit the highlighted codelist. Refer to "8.3 Creating/Editing a Codelist".
Delete	To delete the highlighted codelist.

8.3

Creating/Editing a Codelist

Access

In **Codelists** press **New** or **Edit**.

New Codelist or Edit Codelist

Key	Description
Store	To store the codelist.
Codes	To access Codes where codes can be created, edited or deleted and code groups can be accessed.

Description of fields

Field	Option	Description
Name	Editable field	A unique name for the codelist. The name can be up to 16 characters long and include spaces. Input required.
Description	Editable field	A detailed description of the codelist. This description can be, for example, work to be performed. Input optional.
Creator	Editable field	The name of the person who is creating the codelist. Input optional.

8.4

Managing Codes

8.4.1

Accessing Codes

Description

Managing codes includes

- creating new codes
- viewing codes with their related information
- editing codes
- deleting existing codes.

Access step-by-step

1. In **Codelists**, highlight the codelist of the codes which are to be managed.
2. **Edit** to access **Edit Codelist**.
3. **Codes** to access **Codes**.

Codes

Codes from currently active code groups are shown.

Metadata such as the code description, the quick codes if available, the code groups and the code type are displayed for each code.

The listed codes belong to

the codelist selected from the internal memory when creating a job.

OR

to the job codelist when editing a job.

The * indicates codes which have attributes attached.



Key	Description
OK	To close the panel and return to the panel from where this panel was accessed.
New	To create a code. Refer to "8.4.2 Creating/Editing a Code".
Edit	To edit the highlighted code. Refer to "8.4.2 Creating/Editing a Code".
Delete	To delete the highlighted code.
Fn Group	To view, create, delete, activate and deactivate code groups. Refer to "8.5 Managing Code Groups".
Fn Sort	To sort codes by code name, code description, quick code or the last use.

8.4.2

Creating/Editing a Code



The values for code groups, codes and attributes are case sensitive. For example, the code group Tree is not the same as the code group TREE.



Attribute names that have already been typed in cannot be edited in a job codelist.



A new code can also be created within an app. In this case, the new code is added to the job codelist.



New Code or Edit Code

The screenshot shows a mobile application interface for creating a new code. The title is 'New Code'. There are five input fields: 'Code' with the value '123', 'Code description' with '-----', 'Code group' with '1', 'Code type' with a dropdown menu showing 'Point', and 'Linework' with an unchecked checkbox. At the bottom of the form are two buttons: 'Store' and 'New attrb'. The top of the screen shows a status bar with various icons and system information like 'Hz 0.0001 g' and 'V 0.0000 g'.

Key	Description
Store	To add the new code and any associated attributes to the codelist in the internal memory.
New attrb	To add a new editable field for an attribute of attribute type normal and of value type text.

Description of fields

Field	Option	Description
Code	Editable field	A unique name for the new code. Input required. The name can be up to 48 characters long and include spaces. If using characters other than from the ASCII character set, the allowed length of the code name is shortened, depending on the characters used.
Code description	Editable field	A detailed description of the code. This description can be, for example, the full designation if Code is an abbreviation. Input optional. The description can be up to 48 characters long and include spaces. If using characters other than from the ASCII character set, the allowed length of the code name is shortened, depending on the characters used.
Code group	Selectable list	The code group to which the code is assigned.
Code type	Selectable list	Defines the use of the code. It can be used as point code or as a free code.
Linework	Check box	Available for Coding functionality: Create linework . The setting of this box defines how a smart-box is filled by default.

Field	Option	Description
		When this box is checked, the stringing and linework metadata are displayed in the code box on the user definable page  . When the code is newly selected, a new line is started. When the same point code remains selected, the next point being stored is added to the current line. When this box is not checked, the code box is set for point coding by default. Linework can still be activated.
Style	Selectable list	Available when Linework is checked. The style in which lines are represented in 3D viewer and Infinity.
Colour	Selectable list	A colour in which the line is displayed.
Attribute field	Editable field	Up to 20 attributes can be created.  Attributes of attribute type mandatory or fixed and of value type real or integer must be created in Infinity.

8.5

Managing Code Groups

Access

In **Codes**, press **Fn Group**.

Code Groups

The listed code groups belong to

the codelist selected from the internal memory when creating a job.

OR

to the job codelist when editing a job.

Codes from currently active code groups are shown.

Check the box in front of a code group to activate the code group.

Uncheck the box in front of a code group to deactivate the code group. Codes belonging to a deactivated code group are not displayed in **Codes**.

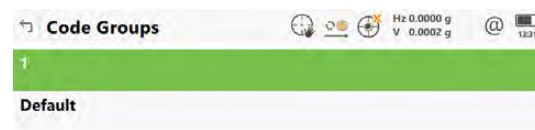

Key	Description
OK	To close the panel and return to the panel from where this panel was accessed.

Key	Description
New	To create a code group. In New Code Group type in a unique name for Name . Store stores the new code group typed in and returns to Code Groups .
Edit	Available for codelists in the internal memory. To edit the highlighted code group. In Edit Code Group type in the changes for Name . Store stores the changes and returns to Code Groups .
None or All	To deactivate or activate all code groups.

9 Coordinate Systems

9.1 Overview

Description

A coordinate system

- allows the conversion from WGS 1984 geodetic or cartesian coordinates to, local cartesian, geodetic or grid coordinates and back.
- can be attached to jobs.
- can be manually defined.
- can be computed in the field.
- can be directly received from a reference network. Refer to "18.7.1 Configuration of a Rover Real-Time Connection".
- can be downloaded to Infinity.
- can be uploaded from Infinity.

Using coordinate systems

Coordinate systems are used on the TS and the CS to combine GNSS data with TS data.



For TS:

An attached coordinate system is not used to reduce any measured distance on a TS instrument.



All GNSS surveyed points are always stored as WGS 1984 geodetic coordinates regardless of the coordinate system being used. Using a different coordinate system converts the coordinates displayed on the panel, but does **not** convert and restore the coordinate values in the database DBX.



For TS:

Points surveyed with a TS instrument are always stored in local grid coordinates regardless of the coordinate system being used.



One coordinate system can be attached to a job at one time. This coordinate system remains attached to the job unless it is changed.

Default coordinate systems

The default coordinate system is **WGS 1984**. It cannot be deleted. It is not possible to create a coordinate system called **WGS 1984**.

Additional default coordinate systems may be available for certain countries.

Active coordinate system

The active coordinate system is the one attached to the job. One coordinate system is always considered as the active coordinate system.

Automatic coordinate system (RTCM transformation parameters)

When **Use auto coordinate system** is checked in the **RTK Rover Wizard**, the coordinate system is directly received from the reference network via RTCM correction data. Refer to "18.7.1 Configuration of a Rover Real-Time Connection".

9.2

Accessing Coordinate System Management

Access

1. From the job menu, select **View & edit job properties**.
2. Go to the **Coordinate system**.

3. Open the selectable list for **Coordinate system**.

Coordinate Systems

Listed are all coordinate systems stored in the database DBX. Any unavailable information is shown as -----.

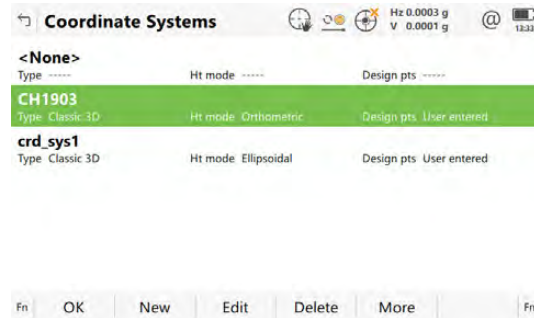

Key	Description
OK	To select the highlighted coordinate system and to return to the previous panel. The selected coordinate system is attached to the job.
New	To create a coordinate system manually. Refer to "9.3 Coordinate Systems - Creating and Editing".
Edit	To edit the highlighted coordinate system. Refer to "9.3 Coordinate Systems - Creating and Editing".
Delete	To delete the highlighted coordinate system. Deletion is not possible if the highlighted coordinate system is active and its source is RTCM.
More	To display information about the type of transformation used, the type of heights computed, the number of control points used for the determination and the date of when the coordinate system was created.
Fn Set deflt	To turn the highlighted coordinate system into a user-defined default coordinate system stored in the instrument.
Fn Default	To recall the deleted default coordinate systems.

9.3

Coordinate Systems - Creating and Editing



Coordinate systems can be defined by manual creation or determined by calculation.

In this chapter, the manual creation of coordinate systems is explained. Refer to "39 Determine Coordinate System" for information on the determination by calculation.



Coordinate systems with a Classic 3D transformation can be defined by manual creation.



The type of transformation of the selected coordinate system determines which elements of a coordinate system can be edited. The name of the coordinate system, the method of residual distribution and the geoid model in use are always editable.



For coordinate systems with source RTCM, only the geoid model in use can be changed.

However, if no projection is received with the automatic coordinate system, then the projection can also be defined.

Access

In **Coordinate Systems**, highlight a coordinate system. A copy of this coordinate system is taken for further configurations. Press **New** or **Edit**.

New Coordinate System or Edit Coordinate System

Key	Description
Store	To store the coordinate system.

Description of fields

Field	Option	Description
Name	Editable field	A unique name for the new coordinate system. The name can be up to 16 characters long and include spaces.
Residuals	<p>Available for transformations with control points. Manually entered transformations do not have control points. The method by which residuals are distributed throughout the transformation area. The transformation results become more realistic and any strain is dispersed in the transformation.</p> <p>1/distance, 1/distance², 1/distance^{3/2}</p> <p>Distribute the residuals of the control points according to the distance between each control point and the newly transformed point.</p> <p>Multiquadratic</p> <p>Distributes the residuals using a multi-quadratic interpolation approach.</p>	
Transformation	Selectable list	The type of transformation.
Pre-transformation	Selectable list	Available when editing a coordinate system and for Twostep transformations. The name of a preliminary 3D transformation, which, together with the selected projection, is used to obtain preliminary grid coordinates for a final 2D transformation.

Field	Option	Description
Ellipsoid	Selectable list	The local coordinates are based on this ellipsoid.
Projection	Selectable list	The map projection.
Geoid model	Selectable list	The geoid model.
CSCS model	Selectable list	The Country Specific Coordinate System model.

9.4 Transformations

9.4.1 Accessing Transformation Management



Transformations cannot be accessed for coordinate systems with source RTCM. Refer to "Automatic coordinate system (RTCM transformation parameters)".

Access step-by-step

1. In **Coordinate Systems**, highlight a coordinate system.
2. Press **New** or **Edit**.
3. Highlight **Transformation**.
4. **ENTER** to access **Transformations**.

Transformations

Listed are all Classic 3D transformations stored in the database DBX. Any unavailable information is shown as -----.

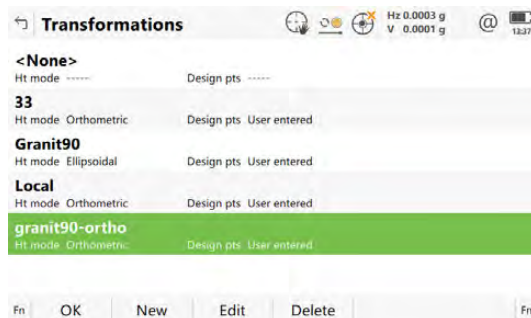

Key	Description
OK	To select the highlighted transformation and to return to the previous panel.
New	To create a transformation. Refer to "9.4.2 Creating/Editing a Transformation".
Edit	To edit the highlighted transformation. Refer to "9.4.2 Creating/Editing a Transformation".
Delete	To delete the highlighted transformation.
Fn Set deflt	To turn the highlighted transformation into a user-defined default transformation stored in the instrument.



Classic 3D transformations can be created.

Access

In **Transformations**, highlight a transformation. A copy of this transformation is taken for further configurations. Press **New** or **Edit**.

New Transformation or Edit Transformation, General page

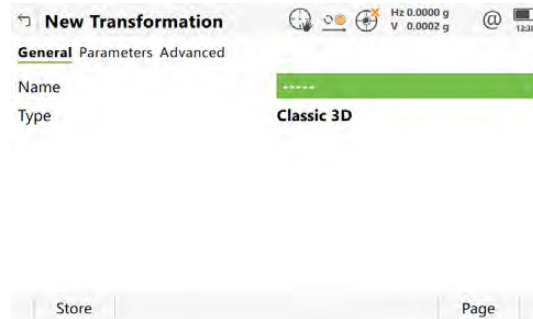

Key	Description
Store	To store the transformation.
Clear	To set the editable fields to 0. Available on the Parameters and the Advanced page.
Page	To change to another page on this panel.

Description of fields

Field	Option	Description
Name	Editable field	A unique name for the new transformation. The name can be up to 16 characters long and include spaces.
Type	Display only	No other transformations than Classic 3D can be created.

Next step

Page changes to the **Parameters** page.

New Transformation or Edit Transformation, Parameters page

Enter the known values of the transformation parameters.

Next step

Page changes to the **Advanced** page.

New Transformation or Edit Transformation, Advanced page

Select at least a height mode and a transformation model.

Description of fields

Field	Option	Description
Height mode	Selectable list	The type of heights to be computed.

Field	Option	Description
Model	Selectable list	The transformation model to be used. For Model: Molodensky-Badekas , more editable fields are available.

Next step

Store stores the transformation.

9.5

Ellipsoids

9.5.1

Accessing Ellipsoid Management



Ellipsoids cannot be accessed for coordinate systems with source RTCM. Refer to "Automatic coordinate system (RTCM transformation parameters)".

Access step-by-step

1. In **Coordinate Systems**, highlight a coordinate system.
2. Press **New** or **Edit**.
3. Highlight **Ellipsoid**.
4. **ENTER** to access **Ellipsoids**.

Ellipsoids

Listed are all ellipsoids stored in the database DBX.

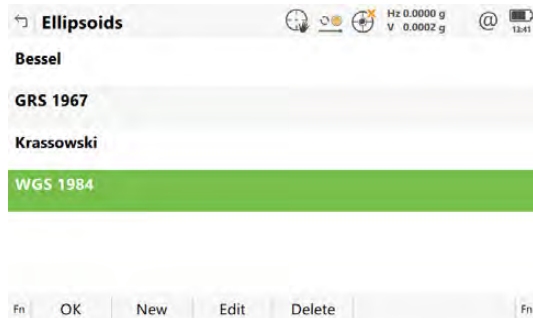

Key	Description
OK	To select the highlighted ellipsoid and to return to the previous panel.
New	To create an ellipsoid. Refer to "9.5.2 Creating/Editing an Ellipsoid".
Edit	To edit the highlighted ellipsoid. Refer to "9.5.2 Creating/Editing an Ellipsoid".
Delete	To delete the highlighted ellipsoid.
Fn Set deflt	To turn the highlighted ellipsoid into a user-defined default ellipsoid stored in the instrument.
Fn Default	To recall the deleted default ellipsoids.

9.5.2

Creating/Editing an Ellipsoid

Access

In **Ellipsoids**, highlight an ellipsoid. A copy of this ellipsoid is taken for further configurations. Press **New** or **Edit**.

New Ellipsoid or Edit Ellipsoid

New Ellipsoid

Name -----

Axis a 6378137.000 m

1/f 298.25722356

Store

Key	Description
Store	To store the ellipsoid.

Description of fields

Field	Option	Description
Name	Editable field	A unique name for the new ellipsoid. A name is mandatory, can be up to 16 characters long and include spaces.
Axis a	Editable field	The semi-major axis a.
1/f	Editable field	The reciprocal value of flattening f.

9.6

Projections

9.6.1

Accessing Projection Management



Projections cannot be accessed for coordinate systems with source RTCM. Refer to "Automatic coordinate system (RTCM transformation parameters)".

Access step-by-step

1. In **Coordinate Systems**, highlight a coordinate system.
2. Press **New** or **Edit**.
3. Highlight **Projection**.
4. **ENTER** to access **Projections**.

Projections

Listed are all projections stored in the database DBX. Any unavailable information is shown as -----.

Projections

<None>

Type -----

Czech JTSK
Type Transverse Mercator

Czech and Slovak
Type Transverse Mercator

DK Bornholm
Type Transverse Mercator

DK Jylland
Type Transverse Mercator

DK S34 Bornholm
Type Transverse Mercator

Fn OK New Edit Delete Fn

Key	Description
OK	To select the highlighted projection and to return to the previous panel.
New	To create a projection. Refer to "9.6.2 Creating/Editing a Projection".
Edit	To edit the highlighted projection. Refer to "9.6.2 Creating/Editing a Projection".
Delete	To delete the highlighted projection.
Fn Set deflt	Available unless a default projection is highlighted. To turn the highlighted projection into a user-defined default projection stored in the instrument.
Fn Default	To recall the deleted default projections.

Description of metadata

Metadata	Option	Description
Type		The projection type. Refer to standard surveying literature for details on projections.
	Customised	Customised projection. Certain fixed projections which cannot be defined by any of the following options.
	Transverse Mercator	Transverse Mercator. Conformal projection onto a cylinder with its axis lying on the equatorial plane. The cylinder is tangential to a meridian.
	TMx	A customised projection for use in the UK, based on the UTM projection.
	UTM	Universal Transverse Mercator. Transverse Mercator Projection with fixed zone-defining constants. The central meridian is selected automatically according to the selected zone number.
	Oblique Mercator	Oblique Mercator. Oblique Mercator Conformal projection onto a cylinder. The cylinder is tangent to any circle other than the equator or a meridian.
	Mercator	Mercator. Conformal projection onto a cylinder with its axis lying on a meridian plane. The cylinder is tangent to the sphere along the equator.
	Lambert 1 parallel	Lambert 1 Parallel. Conformal projection onto a cone, with its axis coinciding with the z-axis of the ellipsoid.
	Lambert 2 parallel	Lambert 2 Parallel. Conformal projection onto a cone, with its axis coinciding with the z-axis of the ellipsoid. The cone is secant to the sphere.

Metadata	Option	Description
	Cassini Soldner	Soldner-Cassini. Projection onto a cylinder. It is not an equal area or conformal. The scale is true along the central meridian and along lines perpendicular to central meridian.
	Polar stereo	Polar Stereographic. Conformal azimuthal projection onto a plane. The point of projection is on the surface of the ellipsoid diametrically opposite of the origin which is the centre of the projection.
	Double stereo	Double Stereographic. Conformal azimuthal projection onto a plane. The point of projection is on the surface of the sphere diametrically opposite of the centre of the projection.
	RSO	Rectified Skewed Orthomorphic. This is a special type of Oblique Mercator projection.

9.6.2

Creating/Editing a Projection

Access

In **Projections**, highlight a projection. A copy of this projection is taken for further configurations. Press **New** or **Edit**.

New Projection or Edit Projection

Key	Description
Store	To store the projection.

Description of fields

Field	Option	Description
Name	Editable field	A unique name for the new projection. A name is mandatory, can be up to 16 characters long and include spaces.
Type	Selectable list	The projection type. The setting determines the availability of the subsequent fields for the parameters of the projection. Refer to "9.6.1 Accessing Projection Management" for a description of the projection types.

9.7

Geoid Models

9.7.1

Overview

Use in the field

For use on the instrument in the field, geoid field files are created from the geoid model.

Create geoid models on the instrument

Geoid models can be created on the instrument in one of two ways:

1. The geoid field file is stored on a data storage device and can be used when the data storage device is inserted in the instrument.
2. The geoid field file is stored in the internal memory of the instrument. Refer to "9.7.3 Adding a New Geoid Model from the Data Storage Device / Internal Memory" for information on how to transfer geoid field files to the internal memory on the instrument.

9.7.2

Accessing Geoid Model Management

Access step-by-step

1. In **Coordinate Systems**, highlight a coordinate system.
2. Press **New** or **Edit**.
3. Highlight **Geoid model**.
4. **ENTER** to access **Geoid Models**.

Geoid Models

Listed are all geoid models stored in the database DBX. Any unavailable information is shown as -----. For example, ----- would be shown if the geoid field file associated to the geoid model is not available on the data storage device/internal memory.

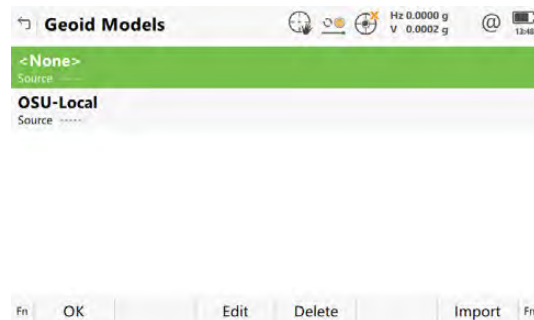

Key	Description
OK	To select the highlighted geoid model and to return to the previous panel.
Edit	To view the highlighted geoid model. None of the fields can be edited. The geoid field file from which the geoid model was created must be stored in the internal memory or in the \DATA\GPS\GEOID directory on the data storage device.
Delete	To delete the highlighted geoid model. The geoid field file which was associated with this geoid model is then also deleted.

Key	Description
Import	To add a geoid model. The \DATA\GPS\GEOID directory on the data storage device is automatically scanned for geoid field files. Refer to "9.7.3 Adding a New Geoid Model from the Data Storage Device / Internal Memory".

9.7.3

Adding a New Geoid Model from the Data Storage Device / Internal Memory

Requirement

At least one geoid field file with the extension *.gem is in the \DATA\GPS\GEOID directory on the data storage device / internal memory.

Add geoid model step-by-step

1. Listed in **Geoid Models** are all geoid models stored in the internal memory.
OR
Press **Import** to scan the \DATA\GPS\GEOID directory on the data storage device.
2. For each geoid field file on the data storage device or in the internal memory, one geoid model is automatically created. The names given to the geoid models are those names which were entered in Infinity.
 Existing geoid models are automatically overwritten by new models with the same name.

9.8

CSCS Models

Use in the field

For use on the instrument in the field, CSCS field files are created from the CSCS model.



Adding a CSCS model on the instrument and the functionality of all panels and fields are similar to those for geoid models. Refer to "9.7.3 Adding a New Geoid Model from the Data Storage Device / Internal Memory".

The directory on the data storage device / internal memory for CSCS field files with the extension *.csc is \DATA\GPS\CSCS.

10

Job Menu - Import data

10.1

Overview

Description

The data to import must be stored on the data storage device or in the internal memory.

Data can be imported to a job

- on the data storage device.
- on the internal memory.

Import formats

Format	Characteristic	Description
ASCII	Import variables	Point ID, grid coordinates, point codes. No free codes, no attributes.
	Format definition	Free format. Use and order of variables and delimiter can be defined during import.
	Units	As currently configured on the instrument
	Height	Orthometric or ellipsoidal
	Specialities	
	Local heights but no coordinates in file	Points are imported without coordinates but with local height and code if available.
	Coordinates but no heights in file	Points are imported without height but with coordinates and code if available.
No coordinates or heights in file	No import	
No point IDs in file	No import	
GSI8GSI16	Import variables	Point ID (WI 11), local coordinates (WI 81, WI 82, WI 83), point codes (WI 71). No free codes, no attributes. Example for GSI8: 110014+00001448 81..01+00001363 82..01-00007748 83..01-00000000 71....+000sheep
	Format definition	Fixed format. Easting and Northing can be switched during import.
	Units	As defined in the GSI file
	Heights	Orthometric or ellipsoidal
Specialities		

Format	Characteristic	Description
	Local heights but no coordinates in file	Points are imported without coordinates but with local height and code if available.
	Coordinates but no heights in file	Points are imported without height but with coordinates and code if available.
	No coordinates or heights in file	No import
	No point IDs in file	No import
DXF	Import variables	Block, point, line, arc, polyline. Local coordinates. No free codes, no attributes.
	Format definition	Fixed format (X/Y/Z).
	Units	Not predefined.
	Heights	Z value imported as orthometric.
	Specialities	
	No coordinates or heights in file	No import
MxGenio	-	-
LandXML	-	-
Terramodel	-	-
Carlson	-	-
Japan XML	-	-
DTM data	Format definition	DXF file containing DTM data
XML data	Import variables	Definable: points, lines, coordinate system, codes, global codelist, alignments, DTM

Checks

Points are always imported with the class **Control** and a coordinate quality of -----. Refer to "I Glossary".

While importing points to a job, checks are performed against point ID, class and coding of points already existing in the job.

10.2

Importing ASCII/GSI Data

Requirements

At least one ASCII file with any file extension, is stored in the \DATA or \GSI directory of the data storage device.



Do not remove the data storage device while importing the data.

Access

From the job menu select **Import data\ASCII / GSI**.

Import ASCII/GSI Data

Key	Description
OK	To import the data.
Display	To view the file from which data is imported.
Fn Settings	To define the format of the data to be imported.
Fn Heights	To define how heights and the Easting are imported.

Description of fields

Field	Option	Description
Data type to import	Selectable list	Defines if ASCII or GSI data are imported.
From	Selectable list	Defines from which storage device the data are imported.
From file	Selectable list	For Data type to import: ASCII data : All files in the \DATA directory on the data storage device can be selected. For Data type to import: GSI data : All files with extension *.gsi in the \GSI directory on the data storage device can be selected.
To job	Selectable list	Available when Create new job on import is not checked.
	Editable field	Available when Create new job on import is checked. The name of the new job.
Create new job on import	Check box	When this box is checked and the file from which the data should be imported is selected the To job field displays a suggested job name. The suggested job name is the name of the file without the extension.
Store imported data	Selectable list	Available when Create new job on import is checked. The new job can either be a job or a design job.
Store new job to	Selectable list	Available when Create new job on import is checked. The device on which the new job is stored.
Display in job carousel	Check box	Available when Create new job on import is checked. When this box is checked, the job is visible in the job carousel.

Field	Option	Description
		When this box is not checked, the job is invisible in the job carousel. Exclude jobs from the job carousel to reduce the scrolling effort.

Next step

Fn Settings accesses, depending on selection for **Data type to import**, either **Settings** or **Settings (GSI)**.

Settings

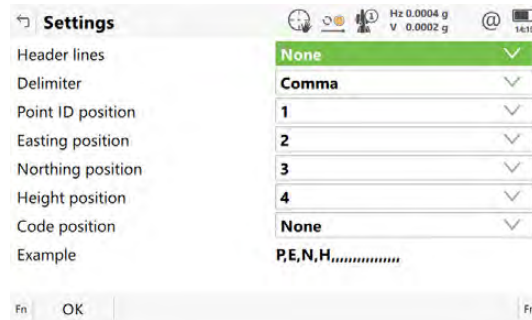

Key	Description
OK	To return to the previous panel.
Fn Default	To recall the default import settings.

Description of fields

Field	Option	Description
Header lines	Selectable list	This option allows up to ten header lines which can exist in an ASCII file to be skipped. Select the number of header lines.
Delimiter	Selectable list	The separator between the import variables.
Point ID position, Easting position, Northing position, Height position and Code position	None (not for Point ID position) and from 1 to 20	Select the positions of the particular variables. An example is shown at the bottom of the panel.
Multiple spaces between data	Check box	Available for Delimiter: Space . Check this box for space delimited data having multiple spaces between the variables. Uncheck this box for space delimited data having one space between the variables.

Field	Option	Description
Number of lines/pt	Selectable list	Available for Delimiter: Line feed . The number of lines used to describe each point.

Next step

1. **OK** leads back to **Import ASCII/GSI Data**.
2. **Fn Heights** to access **Define Ht Type & Easting**.

Settings (GSI)

Description of fields

Field	Option	Description
Switch WI81/WI82	Check box	If this box is checked, then all WI 81 data, normally Easting, is imported as Northing and all WI 82 data, normally Northing, is imported as Easting. This coordinate switch is necessary for "left handed" coordinate systems.
Definition of feet	Selectable list	The type of feet used in the GSI file.

Next step

1. **OK** leads back to **Import ASCII/GSI Data**.
2. **Fn Heights** to access **Define Ht Type & Easting**.

Define Ht Type & Easting

Description of fields

Field	Option	Description
Import as	Selectable list	The height type for the imported data.
Easting	Selectable list	The Easting can be imported as written in the ASCII file or it can be multiplied by -1. This change is required by some coordinate systems.

OK leads back to **Import ASCII/GSI Data**.

10.3

Importing XML Data

Requirements

At least one file in XML format with the file extension *.xml has to be stored in the \DATA directory of the data storage device.

 The file can contain points, lines, alignments (Road/Rail/Tunnel jobs) and DTM's/PLA's.

Access

From the job menu select **Import data\XML**.

Import XML Data

Key	Description
OK	To import the data.

Description of fields

Field	Option	Description
From	Selectable list	Defines from which storage device the data is imported.
From file	Selectable list	All files with extension *.xml in the \DATA directory on the data storage device can be selected.
Import points, lines, coordinate systems & point codes	Check box	When the box is checked, a job can be selected to import the data to.
Import global codelist	Check box	When this box is checked, a global codelist is imported. The codelist must be stored in the \CODE directory of the data storage device.
Import alignments	Check box	When the box is checked, the job type Road , Rail or Tunnel can be chosen. A job name can be entered and a Road , Rail or Tunnel job is created once the data is imported.
Import DTM	Check box	When this box is checked, a job name can be entered and a DTM job is created once the data is imported.

Next step

OK start the import.

10.4

Importing DXF Data

Requirements

At least one file in DXF format with the file extension *.dxf has to be stored in the \DATA directory of the data storage device.



Do not remove the data storage device while importing the data.

Access

From the job menu select **Import data\DXF**.

Import DXF Data

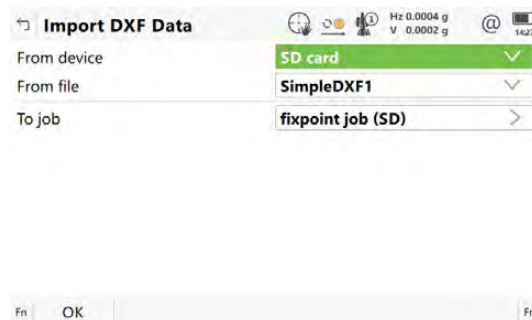

Key	Description
OK	To import the data.
Fn Settings	To define the format of the data to be imported.

Description of fields

Field	Option	Description
From device	Selectable list	Defines from which storage device the data is imported.
From file	Selectable list	All files with extension *.dxf in the \DATA directory on the data storage device can be selected.
To job	Selectable list	Choosing a job as destination for import makes this job the job.

Next step

Fn Settings accesses **DXF Import Settings**.

DXF Import Settings

Description of fields

Field	Option	Description
Block prefix	Editable field	Optional prefix to imported blocks.
Prefix to use for points	Editable field	Optional prefix to imported points.
Prefix to use for lines	Editable field	Optional prefix to imported lines.
Units used within .dxf file	Selectable list	Choosing the unit for the DXF data to be imported.
Objects to create when importing entities	Vertices and lines	<ul style="list-style-type: none"> Imports the CAD lines into the job. Creates points at the starting and the ending coordinates of the imported line/arc/polyline elements.
	Only at vertices	Creates points at the starting and the ending coordinates of the line/arc/polyline elements. The elements are not imported.
	Only lines	Imports only the CAD lines into the job. No points are created.
Convert white elements	Check box	Option if white coloured elements are converted to black coloured elements.
Ignore data at height	Selectable list	Height values inside the DXF file are considered invalid and are not converted.
Apply a height to 2D data	Check box	When this box is checked, a height can be defined which is then applied to all imported 2D CAD points.

Field	Option	Description
Height to apply	Editable field	Available when Apply a height to 2D data is checked. The height to apply to 2D CAD points.

Next step

OK leads back to **Import DXF Data**.

10.5

Importing DTM Data

Requirements

- At least one file in DXF format with the file extension *.dxf has to be stored in the \DATA directory of the data storage device.
- The DXF file must contain a 3D face layer.



Do not remove the data storage device while importing the data.

Access

From the job menu select **Import data\DTM**.

Import DTM Data

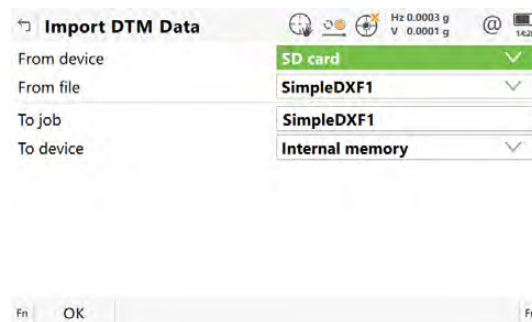

Key	Description
OK	To import the data.
Fn Settings	To define the linear units of the data to be imported.

Description of fields

Field	Option	Description
From device	Selectable list	Defines from which storage device the data are imported.
From file	Selectable list	All files with extension *.dxf in the \DATA directory on the data storage device can be selected.
To job	Editable field	The name of the new DTM job. The job is created once the data is imported.
To device	Selectable list	Defines to which storage device the data are imported.

Next step

Fn Settings accesses **Settings**.

Settings

Description of fields

Field	Option	Description
Linear unit used within file	Selectable list	Choosing the unit for the DXF data to be imported.

Next step

OK leads back to **Import DTM Data**.

10.6

Importing Alignment Data

Requirements

The requirements depend on the file type:

- For **MX Genio**: At least one file in **MX Genio** format with the file extension *.dxf is stored in the \DATA directory of the data storage device.
- For **LandXML/Terramodel/Japan XML**: At least one file in **LandXML/Terramodel/Japan XML** format with the file extension *.xml is stored in the \DATA directory of the data storage device.
- For **MX Genio**: At least one file in **MX Genio** format with the file extension *.txt is stored in the \DATA directory of the data storage device.
- For **Carlson**: At least one file in **Carlson** format with the file extension *.cl is stored in the \DATA directory of the data storage device.

Access

From the job menu select **Import data\Alignment**.

Import Alignment Data

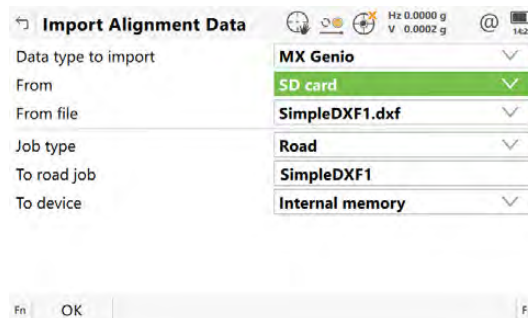

Key	Description
OK	To import the data.
Fn Settings	To define the format of the data to be imported. Available for Data type to import: MX Genio , Data type to import: DXF and Data type to import: Carlson .

Description of fields

Field	Option	Description
Data type to import	Selectable list	Defines which type of data is imported.
From	Selectable list	Defines from which storage device the data is imported.
From file	Selectable list	For Data type to import: DXF : All files with extension *.dxf in the \DATA directory on the data storage device can be selected.

Field	Option	Description
		<p>For Data type to import: LandXML/Carlson/Japan XML: All files with the extension *.xml in the \DATA directory on the data storage device can be selected.</p> <p>☞ For cross section-based LandXML data, vertex connection definitions are mandatory.</p> <p>☞ For Terramodel data, the file must contain the centreline.</p> <p>For Data type to import: MX Genio: All files with the extension *.txt in the \DATA directory on the data storage device can be selected.</p> <p>For Data type to import: Carlson: All Carlson centreline files with the extension *.cl in the \DATA directory on the data storage device can be selected.</p>
Section file	Selectable list	<p>For Data type to import: Terramodel: All ASCII cross section files with the extension *.txt in the \DATA directory on the data storage device can be selected.</p> <p>For Data type to import: Carlson: All Carlson cross section files with the extension *.sct in the \DATA directory on the data storage device can be selected.</p>
Job type	Road and Rail	The type of job the data are converted to.
To road job or To rail job	Editable field	When importing data, a new/empty rail or road job must be created for the data to be stored in.

Settings

This panel is available for **Data type to import: DXF**, **Data type to import: MX Genio** and **Data type to import: Carlson**.

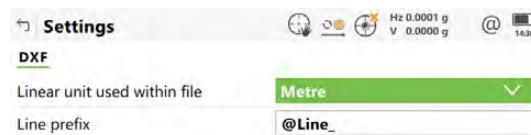

OK

Key	Description
OK	To return to the previous panel.

Description of fields

Field	Option	Description
Linear unit used within file	Selectable list	The units used in the file to import.
Line prefix	Editable field	Available for Data type to import: DXF . The prefix to be used.



Next step

1. **OK** leads back to **Import Alignment Data**.
2. **OK** opens, depending on the selections made, a panel for the line, layer or track selection.

Import MX Genio Data, for Road jobs

Key	Description
OK	To start the import.
Centre	To set the highlighted line as centreline.
Use	To set Yes or No in the Use metadata for excluding/including the highlighted line from/to import.

 Line selection is also possible in **3D viewer**.

IF	THEN
a single line must be selected	tap on the line.
multiple lines must be selected	click the icons:  and  Drag the stylus on the panel in a diagonal line to make a rectangular area.
the context menu must be activated	hold down the supplied stylus anywhere on the map for 0.5 second. Refer to "35.6 Context Menu".  To deselect all objects for import, select Clear selection .

Description of metadata

Metadata	Description
-	Displays the name of all the lines in the layer.
Centreline	Shows Centreline for the line selected as centreline.
Use	For Yes : The selected line is used for the import. For No : The selected line is not used for the import.

Next step

OK start the import.

Define Track Design, MxGenio for Rail jobs

For MxGenio, only single track Rail jobs can be created.

Key	Description
OK	To start the import.
Ch CL	To select/deselect the highlighted line as external chainage centreline. The selection is optional.
Track cl	To select/deselect the highlighted line as track centreline. The selection is mandatory.
Left rail	To select/deselect the highlighted line as left rail. The selection is optional.
Right rail	To select/deselect the highlighted line as right rail. The selection is optional.

 Line selection is also possible in **3D viewer**.

IF	THEN
a single line must be selected/deselected	tap on the line.
the context menu must be activated	hold down the supplied stylus anywhere on the map for 0.5 second. Refer to "35.6 Context Menu".



Description of metadata



Metadata	Description
-	Displays the name of all the lines.
Use as	Displays a line selected as external chainage centreline, track centreline, left rail or right rail.

Next step

OK start the import.

Select Layers to Import, for DXF Road/Rail data, LandXML Road/Rail data, Terramodel Road data and Carlson Road data

Key	Description
OK	To start the import.
Edit	<ul style="list-style-type: none"> For Road: To define the centreline and to exclude/include the highlighted line from/to import. For Rail: To define the external chainage centreline (optional), to define the track centreline (mandatory), to define the left rail (optional) and to define the right rail (optional).
	By default, the longest line is set as the centreline.
	For DXF and LandXML data (Road and Rail), line selection, per layer, is also possible in 3D viewer . Names of the Road lines from design data are displayed in black. Names of the selected line is displayed in red.
	<ul style="list-style-type: none"> To select a single line, tap on the line.

Key	Description
	<ul style="list-style-type: none"> For Road: To select multiple lines, click the  and  icon, drag the stylus on the panel in a diagonal line to make a rectangular area. To activate the context menu, hold down the supplied stylus anywhere on the map for 0.5 second. Refer to "35.6 Context Menu".
Use	To set Yes or No in the Import: metadata for excluding/including the highlighted layer from/to import.
Fn All or Fn None	To change the setting for the Import: metadata for all layers at once.

Description of metadata

Metadata	Description
-	Displays the name of all layers available for importing.
Centreline	Shown for the line selected as centreline.
Import:	For Yes: The selected layer is used for the import. For No: The selected layer is not used for the import.

Next step

OK start the import.

11

Job Menu - Export data

11.1

Overview

Description

Data can be exported

- to a file on the data storage device.
- to a file on the internal memory.

Export format

Format	Characteristic	Description
ASCII	Export variables	Point ID, grid coordinates, point codes, code description, up to four attributes and linework. No free codes.
	Format definition	Free format. Use and order of variables and delimiter can be defined during export.
	Units	As currently configured on the instrument
	Height	Orthometric or ellipsoidal
ASCII with format file	Export variables	Refer to the online help of Leica Geo Office or Leica Instrument Tools.
	Format definition	Composed individually as format file using Leica Geo Office or Leica Instrument Tools. Refer to the online help of Leica Geo Office or Leica Instrument Tools for information on creating format files.
	Units	Defined within the format file.
	Coordinate conversion	All coordinate types are supported.
	Height	All height types are supported. If the desired height cannot be computed, the default value for the missing variable is output.
	Specialities: Points in file outside of CSCS model	If the variable is missing, the default value is output.
Points in file outside of geoid model	If the variable is missing, or a geoid separation is available, the default value is output.	
DXF	Coordinate conversion	All points are converted to local grid position using the coordinate system.
	Height	Orthometric height and ellipsoidal height are supported.
	Specialities: Points in file outside of CSCS model	Points outside of CSCS model are not exported.

Format	Characteristic	Description
	Points in file outside of geoid model	The ellipsoidal height is exported.
XML	Coordinate conversion	All points are converted to local grid position using the coordinate system.
	Height	Orthometric height and ellipsoidal height are supported.
	Specialities:	
	Points in file outside of CSCS model	Local grid position of the points outside of CSCS model is not exported.
	Points in file outside of geoid model	The ellipsoidal height is exported.
Fbk, Rw5, Raw	Coordinate conversion	All points are converted to local grid position using the coordinate system.
	Height	If a geoid model exists, then orthometric height is supported, otherwise ellipsoidal height is exported.
	Units	Metre, US Ft or Int Feet, Gons, Dec Deg, DMS

11.2

Exporting Data from a Job to an ASCII Format

Description

The settings on this panel define the data that is converted and exported and what format is used.

Data is exported from the selected job. Currently active view, filter and sort settings are applied.

Access

From the job menu select **Export data\ASCII**.

Export ASCII Data

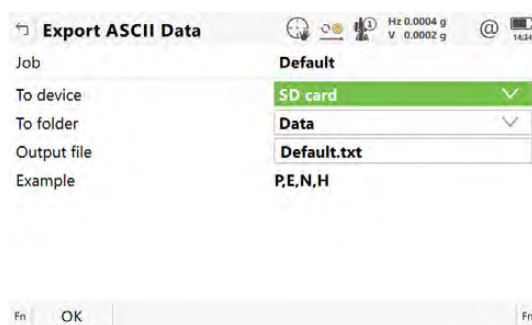

Key	Description
OK	To select the highlighted format file.
Fn Settings	To define the format of the data to be exported.
Fn Filter	To define the order in which points and lines are exported as well as which points are exported.

Key	Description
Fn Coord sys	To update the coordinate system in which the coordinates are exported.

Description of fields

Field	Option	Description
Job	Selectable list	To select the job to export.
To device	Selectable list	Defines where the exported data are saved to.  For To device: Internal memory the data is always exported to the \DATA directory.
To folder	Selectable list	The data can be exported to the \DATA or the root directory or to the folder where the selected job is located.
Output file	Editable field	The name of the file to which the data is exported.

Next step

Fn Settings accesses **Settings**.

Settings

Key	Description
OK	To return to the previous panel.
Fn Default	To recall the default import settings.

Description of fields

Field	Option	Description
Delimiter	Selectable list	The separator between the import variables.
1st position to 8th position	None, Point ID, Easting, Northing, Height, Code, Code information, Code & code info, Code description, Attribute 1 to Attribute 4 and Linework	Select the variable of the particular positions. An example is shown on the Export ASCII Data panel.

11.3

Exporting Data from a Job to a Custom Format

Description

The settings on this panel define the data that is converted and exported and what format is used.

Data is exported from the selected job. Currently active view, filter and sort settings are applied.

Requirements

At least one format file was created using Leica Geo Office or Leica Instrument Tools and transferred to the internal memory.

Access

From the job menu select **Export data\ASCII with format file**.

Export ASCII (Format File)

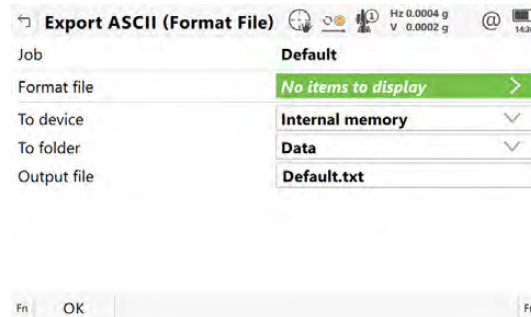

Key	Description
OK	To select the highlighted format file.
Fn Settings	To configure the default extension to be used.
Fn Filter	To define the order in which points and lines are exported as well as which points are exported.
Fn Coord sys	To update the coordinate system in which the coordinates are exported.

Description of fields

Field	Option	Description
Job	Selectable list	To select the job to export.
Format file	Selectable list	The format files currently available in the internal memory.
To device	Selectable list	Defines where the exported data are saved to.  For To device: Internal memory the data is always exported to the \DATA directory.
To folder	Selectable list	Available for To device: SD card , and To device: USB . The data can be exported to the \DATA, the \GSI or the root directory or to the folder where the selected job is located. Data must be stored to the \GSI directory to be read in a TS instrument.
Connect using	Display only	Available for To device: RS232 . The port currently configured for the RS232 interface.

Field	Option	Description
Device	Display only	Available for To device: RS232 . The device currently configured for the RS232 interface.
Output file	Editable field	The name of the file to which the data is exported.

11.4

Exporting Data in DXF Format

General

Data can be exported to a DXF file in a data storage device or the internal memory.



Do not remove the data storage device while exporting the data.

Access

From the job menu select **Export data\DXF**.

Export DXF Data

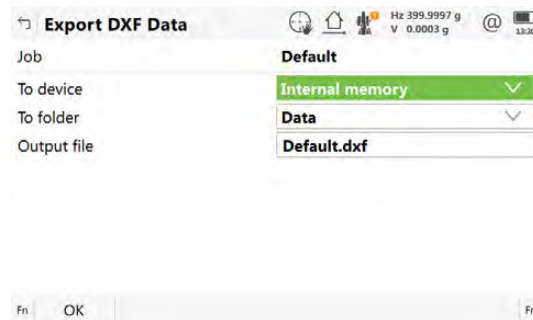

Key	Description
OK	To accept the settings.
Fn Settings	To define what is exported.

Description of fields

Field	Option	Description
Job	Selectable list	To select the job to export.
To device	Selectable list	Available for To folder: Data . Defines which data storage device the data is exported to.
	Display only	Available for To folder: Same as job . Displays the data storage device of the selected Job .
To folder	Selectable list	Defines if the data is exported to the \DATA directory or to the folder where the selected job is located.
Output file	Editable field	The name of the file to which the data is exported.

Next step

Fn Settings goes to **Settings, Objects to be exported** page.

Settings, Objects to be exported page

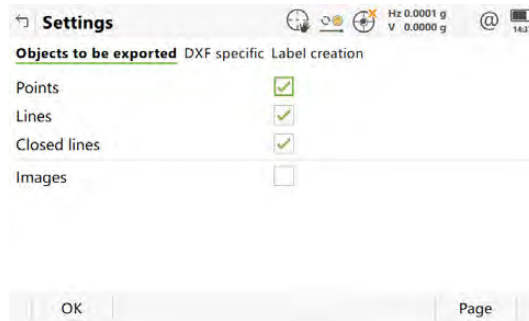

Key	Description
OK	To export the data.
Filter	To define the order in which points and lines are exported as well as which points are exported. Refer to "7.6 Point Sorting and Filters".
Page	To change to another page on this panel.

Description of fields

Field	Option	Description
Points	Check box	When this box is checked, points are exported.
Lines	Check box	When this box is checked, lines are exported.
Images	Check box	When this box is checked, images are exported.

Next step

Page changes to the **DXF specific** page.



For information on camera and images refer to "32.6 Exporting Images".

Settings, DXF specific page

Description of fields

Field	Option	Description
Export lines & closed lines	Selectable list	Defines if lines and closed lines are exported as line or polyline entities.
Symbol size	Editable field	Defines the size used for creation of symbols.
Dimensions	Selectable list	Defines if the data is exported as 2D or 3D.
DXF layer to export to	Selectable list	Defines the DXF layer.
Export symbols	Check box	When this box is checked, the relevant symbols are also exported.

Next step

Page changes to the **Label creation** page.

Settings, Label creation page

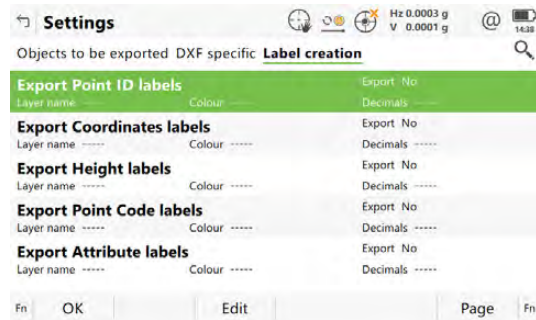

Key	Description
OK	To accept the settings.
Edit	To define if the label is exported, its colour, the number of decimal places to use and what layer or block it is exported to.
Page	To change to another page on this panel.
Fn About	To display information about the program name, the version number, the date of the version, the copyright and the article number.

Description of metadata

Metadata	Description
-	The name of the label.
Export	Shows if the label is exported or not.
Layer name	The name of the layer that is exported which can be: <ul style="list-style-type: none">Name of a user-defined layer If the label is exported to a user-defined layer.Same layer as point If the label is exported to the same layer as the point symbol.Block with point If the label is exported to a block with the point symbol.----- The label is not exported.
Colour	The colour of the label.
Decimals	The number of decimals used.

Next step

Edit access a panel to define the export labels.

Export label

Description of fields

Field	Option	Description
First check box in panel	Check box	When this box is checked, the chosen label types are exported.  All other fields on the panel are active and can be edited.
Colour	Selectable list	Defines the colour for the label.
Export to	User defined Same layer as point Block with point	The label is exported to a user-defined layer. The label is exported to the layer which the point symbols are exported to. The label is exported to a block with the point symbol and all other labels which are also set to be exported to Block with point . Only one block is created for a point and there can be one or more labels in this block.
Layer name	Selectable list	Available for Layer name: User defined is checked. The name of the layer.
Export code descriptions	Check box	Available when Export Point Code labels is highlighted in Settings, Label creation page. Defines if the code descriptions are exported with the point code.
Export attribute names	Check box	Available when Export Attribute labels is highlighted in Settings, Label creation page. Defines if the attribute names are exported with the attribute values.

Next step

OK returns to **Settings**.

11.5

Exporting Data in XML Format

General

Data can be exported to an XML file in the

- \DATA directory or
- same directory as the job is in

on the

- data storage device or
- internal memory.



Do not remove the data storage device while exporting the data.

Access

From the job menu select **Export data\XML**.

Export XML Data

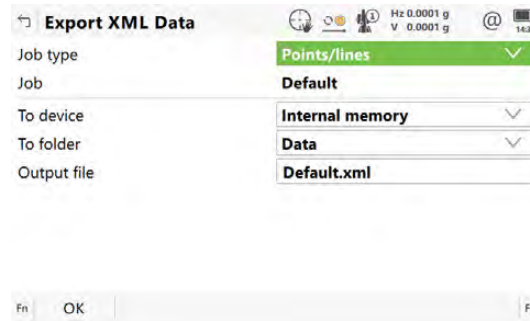

Key	Description
OK	To export the data.
Fn Settings	To define what is exported.

Description of fields

Field	Option	Description
Job type	Points/lines, Road, Rail or Tunnel	The type of job to be exported. To use this option, select LandXML version: 1.2 and check Use Hexagon XML extension in Settings, XML page.
Job	Selectable list	To select the job to export. The selectable list depends on the setting for Job type .
To device	Selectable list	Defines where the exported data are saved to.
To folder	Selectable list	The data can be exported to the \DATA directory or to the folder where the selected job is located.
Output file	Editable field	The name of the file to which the data is exported.

Next step

Fn Settings goes to **Settings, Export** page.

Settings, Export page

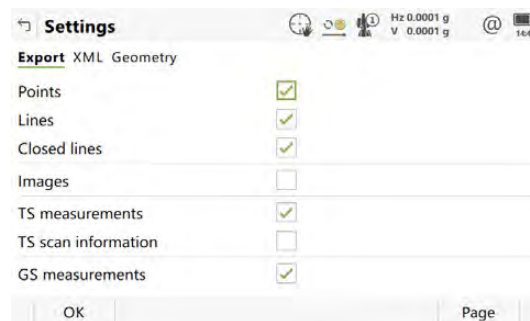

Key	Description
OK	To return to the previous panel.
Page	To change to another page on this panel.

Description of fields

Field	Option	Description
Points	Check box	When this box is checked, points are exported.
Lines	Check box	When this box is checked, lines are exported.
Closed lines	Check box	When this box is checked, closed lines are exported.
Images	Check box	When this box is checked, all onboard, TS and panoramic images are exported.
TS measurements	Check box	When this box is checked, TS observations are exported.
TS scan information	Check box	When this box is checked, information about any scans is exported. This includes the scan definition information, but not the current scan points.
GS measurements	Check box	When this box is checked, GPS observations are exported.
Codes	Check box	When this box is checked, point codes and line codes are exported.
Free codes	Check box	When this box is checked, the free code, free code description, free code group and the free code attributes, are all exported to the LandXML file associated to each exported point. Free code export works also when Use Hexagon XML extension is checked on the XML page.
App results	Check box	When this box is checked, all app results are exported. They are only exported when Use Hexagon XML extension is checked on the XML page.

Next step

Page changes to the **XML** page.



For information on camera and images refer to "32.6 Exporting Images".

Settings, XML page

Description of fields

Field	Option	Description
Dimensions	Selectable list	Defines the dimension of the exported entities.
LandXML version	Selectable list	Defines the LandXML version of the file exported file.
Use Hexagon XML extension	Check box	Available for LandXML version: 1.2 . When this box is checked, a job type can be selected for the export in the Export XML Data panel.

Next step

Page changes to the **Geometry** page.

Settings, Geometry page

Description of fields

Field	Option	Description
Export splines as Civil 3D multi arc	Check box	When this box is checked, splines will be exported as multi-arcs. This is needed since some CAD software does not support splines. The use of this check box allows long, meandering objects in the field, such as fence lines, can be measured as splines and still be accurately represented in all CAD packages - even those where splines are not supported
Export closed lines as Parcels	Check box	When this box is checked, closed lines are exported as parcels. When this box is not checked, the closed lines are exported as plan features but with the same the contents as for parcels. Then software such as Carlson can import closed lines from a LandXml file, as they only read plan features in their field-to-finish routine. Parcel objects are used in AutoCAD Civil 3D. Parcels represent lots in a subdivision of real estates or features with closed boundaries, such as bodies of water and soil regions.

11.6

Exporting Data using Stylesheets

Access

From the job menu select **Export data\XML with stylesheet.**

Export XML (Style-sheet)

Key	Description
OK	To export the data.

Description of fields

Field	Option	Description
Job type	Points/lines, Road, Rail or Tunnel	The type of job to be exported.
Job	Selectable list	To select the job to export.
Use protected style-sheets	Check box	When this box is checked, a protected style-sheet is used. *.lss files currently available in the \CONVERT folder on the internal memory are listed. When this box is not checked, a standard stylesheet is used. *.xsl files currently available in the \CONVERT folder on the internal memory are listed.

Field	Option	Description
Password	Editable field	Available when Use protected stylesheets is checked. The password allows the use of *.lss protected stylesheets. The password can have 16 characters at maximum. If the password is correct and OK is pressed, then the export will be carried out If the password is incorrect and OK is pressed, then the export cannot be carried out. An error message is displayed in case of a wrong password or a problem derived from the export.
Stylesheet to use	Selectable list	The style sheets currently available in the \CONVERT folder on the internal memory.
Description	Display only	A detailed description of the style sheet. When Use protected stylesheets is not checked, then this information is entered by the user in a variable within the style sheet. When Use protected stylesheets is checked and the correct password was typed in, then this information read and displayed from the style sheet.
To device	Selectable list	Defines where the exported data is saved to.
To folder	Selectable list	The data can be exported to the \DATA directory or to the folder where the selected job is located.
Output file	Editable field	The name of the file to which the data is exported. The file extension is defined by the user in a variable inside the style sheet. Default is "txt" if the extension has not been defined.

11.7

Exporting Data in FBK/RW5/RAW Format

General

Data can be exported to file with the format of:

- AutoDesk FBK
- TDS RAW
- TDS RW5
- Carlson RW5
- MicroSurvey RW5
- Bentley's software solutions

The newly created file is stored in the \DATA directory of the data storage device or to the folder where the export job is located.

The formatted FBK files can be imported directly into Autodesk products.

The created RW5, RAW and RWD files can be processed with various survey office packages.

Although the export operation converts any job to an FBK/RW5/RAW/RWD file, the figure creation is based on existing lines present in the job.



Do not insert "best fit arc" geometry in the linework. CAD packages do not support "best fit arc" geometry via FBK or RW5 formats. Line geometry modifications (editing or reversing) that are done after line-work measurements are only supported by the FBK format.

Point codes

Each point collected should have a point code.

IF you are creating	THEN
Autodesk FBK file	Point codes are used to match the Description Keys in Autodesk LDT and Civil 3D to each position located.
TDS RW5 file	Point codes are used to generate raw linework in TDS Foresight.
MicroSurvey RW5 file	Point codes are used to match the Description Keys in MicroSurvey CAD to each position located.

Line ID

IF you are creating	THEN
Autodesk FBK file	The figure ID follows the user selection as defined in the setting menu.
TDS RW5 file	The line IDs are not used when importing data into TDS Foresight.
MicroSurvey RW5 file	The line IDs are not used when importing data into MicroSurvey CAD 2005.



Do not remove the data storage device while exporting the data.

Access

From the job menu select **Export data\Fbk, Rw5, Raw**.

Export Fbk/Rw5/Raw/Rwd

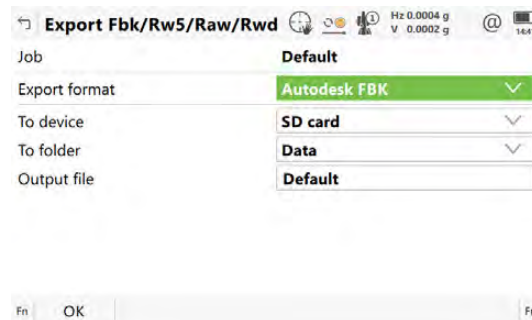

Key	Description
OK	To export the data.
Fn Settings	To configure some format-specific options.

Description of fields

Field	Option	Description
Job	Selectable list	To select the job to export.
Export format	Autodesk FBK, TDS RW5, TDS RAW, Carlson RW5, MicroSurvey RW5 or Bentley RWD	Ensure that this field is set properly.
To device	Selectable list	Defines where the exported data are saved to.
To folder	Display only	The data can be exported to the \DATA directory or to the folder where the export job is located.
Output file	Editable field	Default is the name of the selected Job . It can be changed.  The extension designation (.FBK, .RW5, .RAW or RWD) is added automatically.

Next step

Fn Settings to access the setting panel.

Settings for Fbk Export, General page

Description of fields

Field	Option	Description
Use numerical point ID	Check box	Available unless Export format: TDS RW5 .
Point ID offset	Editable field	Available when Use numerical point ID is checked. The point IDs are offset by this value.
Use angle right	Check box	Define if angle right values are exported.
Split measurements and figures	Check box	When this box is checked, TS linework is shifted after the measurements. This setting supports cases where the line is edited or reversed.
Figure ID		Available for Export format: Autodesk FBK, Export format: Carlson RW5 and Export format: MicroSurvey RW5 . The name that will be assigned to the figure or linework geometry in the CAD program.
Point code		The point code is used as ID.

Field	Option	Description
	Line ID	Selecting Line ID is the only way to support simultaneous lines for Carlson RW5 and MicroSurvey RW5 formats. TDS RW5 and TDS RAW formats have no way to support simultaneous lines.
Create feature code (FC) and attribute (AT) records	Check box	Available for Export format: TDS RAW . When this box is checked, the Feature Code and Attribute records are used to provide point code and attributes in a more detailed format.
Append first 2 attributes to pt code instead of creating AT records	Check box	Available for Export format: TDS RAW and when Create feature code (FC) and attribute (AT) records is checked. When this box is checked, then the two first attributes are appended directly to the code and not written as Attribute record.

Next step

Page changes to the **Objects** page.

Settings for Fbk Export, Objects page



Key	Description
OK	To return to Export Fbk/Rw5/Raw/Rwd .
All	To check all boxes at once.
Page	To change to another page on this panel.
Fn About	To display information about the app name, the version number, the date of the version, the copyright and the article number.

Description of fields

Field	Option	Description
All fields	Check box	To include points from an app, check a box.

Next step

OK returns to **Export Fbk/Rw5/Raw/Rwd**.

11.8

Copy Data Between Jobs

Description

This chapter explains the process of copying data from one job to another.



Important features:

- Points are copied as defined by the point filter settings.
- Points selected for copying can be viewed in a points listing. The point sort settings define the order of the points in the listing. The point filter settings define the points to be viewed in the listing.
- Only points are copied - observation data is not copied.
- When points are copied from one job to another:
 - the point codes and attached attributes are also copied.
 - the **Class** is retained.
 - the **Sub class** is retained.
 - the **Source** is changed to **Copied Point**.
 - the point coordinate quality is retained.
 - the **Date** and **Time** is retained.

Access

From the job menu select **Export data**, scroll down and select **Between jobs**.

Copy Data Between Jobs

Copy Data Between Jobs

From job: Default

Coordinate system: <None>

To job: Default

Fn OK Fn

Key	Description
OK	To copy a selection of points.
Filter	To define the point sort and/or point filter settings of points from the job. Refer to "7.6 Point Sorting and Filters".
Data	To view, edit and delete points and lines stored with the job. Points and lines are shown on separate pages. Selected sort and filter settings apply. Refer to "7 Job Menu - View & edit data".

Description of fields

Field	Option	Description
From job	Selectable list	Describes where the points are copied from.
To job	Selectable list	Describes where the points are copied to.



All changes made affect the design job.

Linked jobs and global data

Linked jobs will overwrite the points and lines from the global design job selected in **Design Data**.

Access

Select **Leica Captivate - Home: Create pts & lines**.



Data displays the data in the design job.

Create a Point, Coordinates page

For all point fields, the 3D viewer can be used to select the desired point.

Key	Description
Store	To store the line/arc to the design job.
Next	To store the line/arc and to remain in the panel. The line ID increments according to line ID template.
Meas app	To measure a point manually. Available when a point field is highlighted.
Fn Indiv ID and Fn Run	To change between entering an individual line ID different to the defined ID template and the running line ID according to the ID template.

Description of fields

Field	Option	Description
Line ID	Editable field	The name of the new line. The configured ID template for lines is used. The ID can be changed in the following ways: <ul style="list-style-type: none"> To start a new sequence of line IDs, type over the line ID. For an individual name independent of the ID template Fn Indiv ID. Fn Run changes back to the next ID from the configured ID template.
Azimuth	Editable field	The azimuth of the line from the start point.
Difference in height	Editable field	The difference in height from the start point to the end point of the line.
Grade	Editable field	The gradient of the line from the start point to the end point of the line.
Horizontal distance	Editable field	The horizontal grid distance from the start point to the end point of the line.
Line length	Display only	For lines: The horizontal grid distance between the two points of the line. If the distance cannot be calculated, ----- is displayed. For arcs: The horizontal grid distance along the arc between the points. If the distance cannot be calculated, ----- is displayed.

Field	Option	Description
Radius	Editable field	The radius of the arc.
Start point	Selectable list	The first point forming the line.
Second point	Selectable list	The medium point forming the arc.
End point	Selectable list	The last point forming the line.
Point ID	Editable field	The end point of the defined line. Available for creating a line with Method:Point, brng, dist, height diff or Point, brng, dist, grade .

Methods for creating lines, arcs and polylines

Description of fields

Field	Option	Description
Method		Select one of the following options to create a line/arc/polyline.
	2 points and Line from 2 points	For lines/polylines. Uses two known points to define the line.
	Point, brng, dist, grade and Line from point, bearing, distance & grade	For lines/polylines. Defines the line using a known point, a distance, an azimuth and the gradient of the line. A new point is created at the end of the line.
	Point, brng, dist, height diff and Line from point, bearing, distance & height difference	For lines/polylines. The same as Point, brng, dist, grade/Line from point, bearing, distance & grade but uses the difference in height instead of the gradient. A new point is created at the end of the line.
	3 points and Arc from 3 points	For arcs/polylines. Defines the arc using three known points.
	2 points & radius and Arc from 2 pts & a radius	For arcs/polylines. Defines the arc with two known points and a known radius.

Create new line/arc

For all point fields, the 3D viewer can be used to select the desired point.

Key	Description
Store	To store the line/arc to the design job.
Next	To store the line/arc and to remain in the panel. The line ID increments according to line ID template.

Key	Description
Meas app	To measure a point manually. Available when a point field is highlighted.
Fn Indiv ID and Fn Run	To change between entering an individual line ID different to the defined ID template and the running line ID according to the ID template.

Description of fields

Field	Option	Description
Line ID	Editable field	The name of the new line. The configured ID template for lines is used. The ID can be changed in the following ways: <ul style="list-style-type: none"> To start a new sequence of line IDs, type over the line ID. For an individual name independent of the ID template Fn Indiv ID. Fn Run changes back to the next ID from the configured ID template.
Azimuth	Editable field	The azimuth of the line from the start point.
Difference in height	Editable field	The difference in height from the start point to the end point of the line.
Grade	Editable field	The gradient of the line from the start point to the end point of the line.
Horizontal distance	Editable field	The horizontal grid distance from the start point to the end point of the line.
Line length	Display only	For lines: The horizontal grid distance between the two points of the line. If the distance cannot be calculated, ----- is displayed. For arcs: The horizontal grid distance along the arc between the points. If the distance cannot be calculated, ----- is displayed.
Radius	Editable field	The radius of the arc.
Start point	Selectable list	The first point forming the line.
Second point	Selectable list	The medium point forming the arc.
End point	Selectable list	The last point forming the line.
Point ID	Editable field	The end point of the defined line. Available for creating a line with Method:Point, brng, dist, height diff or Point, brng, dist, grade .

Create new polyline - Several segments

1. In **Create a Polyline** select **Several segments**.

2. Select the method to use for the first segment. Refer to "Methods for creating lines, arcs and polylines" for a description of methods.
3. Type in the values for the first segment. Refer to "Create new line/arc" for a description of the fields.
4. **Next** to store the segment.
5. Repeat step 2. to 4. until all segments are entered.
6. **Finish** to store the polyline.

Create new polyline - Several entered points

In **Create a Polyline** select **Several entered points**.

Key	Description
Store	To store the line to the design job.
Fn Indiv ID and Fn Run	To change between entering an individual line ID different to the defined ID template and the running line ID according to the ID template.

Description of fields

Field	Option	Description
Line ID	Editable field	<p>The name of the new line. The configured ID template for lines is used. The ID can be changed in the following ways:</p> <ul style="list-style-type: none"> • To start a new sequence of line IDs, type over the line ID. • For an individual name independent of the ID template Fn Indiv ID. Fn Run changes back to the next ID from the configured ID template.
Create line from these points	Editable field	<p>Enter a list of points from the design job and characters to define the line.</p> <p>.</p> <p>Entering a dot between the points adds point-by-point to the polyline. Example: Entering 1.3.5 creates a polyline with the points 1, 3 and 5 in that order.</p> <p>-</p> <p>Entering a minus between the points adds all points between the two points to the polyline, according to the point ID ordering. Example: Entering 1-5 creates a polyline with all points between 1 and 5.</p> <p> This can only be used with numeric point IDs.</p> <p>()</p> <p>Entering () creates an arc between the points which are outside () through the point which is inside (). Example: Entering 1(3)5 creates a 3-point arc from 1 to 5 through 3 as the arc mid point.</p>
Line length	Display only	The calculated 2D line length according to the selected points. Units according to distance in regional settings.

Field	Option	Description
		 The line length is shown in the unit configured in Regional, Distance page.

Create Offset Line & Points

Key	Description
OK	To store the line/points to the design job.
Page	To change to another page on this panel.

Description of fields

Field	Option	Description
Line ID	Selectable list	To select a line. Open the selectable list to access the Line Selection panel showing all selectable lines from the design job.
Objects to create	Line	To create lines only.
	Points	To create points only.
	Line & points	To create lines and points.
	Single point	To create only one point.
Offset	Editable field	Perpendicular offset of the line. Left is negative. Right is positive.
Line ID	Editable field	The name of the new line. The configured ID template for lines is used. Type over the line ID to change it.
Starting point ID	Editable field	The point ID of the line start point. The configured ID template for points is used.
Start chainage	Display only	The beginning chainage of the line.
Chainage	Editable field	Chainage of the current position along the line.
Point ID	Editable field	The name of the new point. The configured point ID template is used. The ID can be changed in the following ways: <ul style="list-style-type: none"> To start a new sequence of point IDs, type over the point ID. For an individual name independent of the ID template Fn Tools and then Individual point ID. Fn Tools and then Sequential point ID changes back to the next ID from the configured ID template.

Extend existing poly-line

1. In **Choose line to extend** select the line to extend.
2. **OK**.

3. Continue as if creating a new polyline. Refer to "Create new polyline - Several segments".
-

13

Connections - GS connection wizard

Description

This chapter explains how the field controller can be connected with a GNSS antenna using a wizard.

Access

Select **Leica Captivate - Home: Settings\Connections\GS connection wizard**.

 Unavailable for CS35.

GS Connection Wizard - Step 1

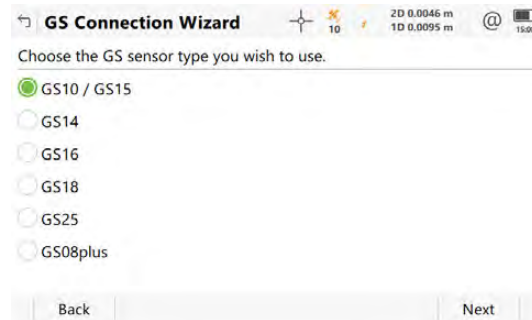

Key	Description
Back	To return to the previous panel.
Next	To confirm the settings and to continue to the next panel.

GS Connection Wizard - Step 2

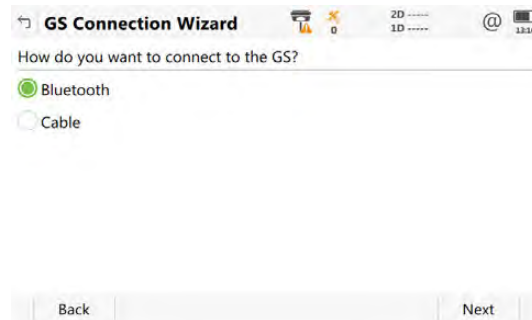

Key	Description
Back	To return to the previous panel.
Next	To confirm the settings and to continue to the next panel.

Next step

Next changes to the next panel.

IF	THEN
connected using cable	follow the instructions on the panel.
connected using Bluetooth	the panel shown depends on whether a Bluetooth GS connection has previously been configured or not.

GS Connection Wizard - Step 3

This panel is displayed if a Bluetooth connection has previously been configured.

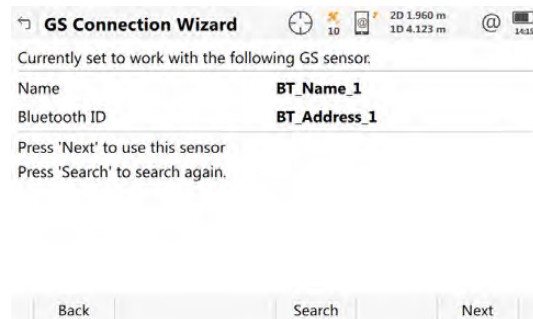

Key	Description
Back	To return to the previous panel.
Search	To search for a different GS instrument.
Next	To confirm the settings and to continue to the next panel.

Next step

Follow the instructions on the panel.

GS Connection Wizard - Step 4

This panel is displayed if NO Bluetooth connection has previously been configured.

Move the focus using the arrow keys or the stylus to select a Bluetooth device.



Key	Description
Back	To return to the previous panel.
Search	To search again for a GS.
Next	To connect to the selected device and continue to the next panel.

Next step

Follow the instructions on the panel.

14

Connections - TS connection wizard

14.1

Starting the TS Connection Wizard

Description

This chapter explains how the field controller can be connected with a total station using a wizard.

Access

Select **Leica Captivate - Home: Settings\Connections\TS connection wizard**.



Unavailable for CS35.

TS Connection Wizard - Step 1

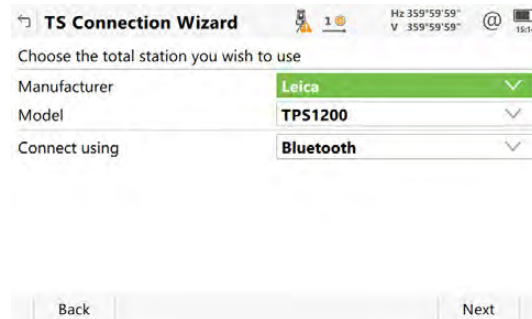

Key	Description
Back	To return to the previous panel.
Next	To confirm the settings and to continue to the next panel.

Description of fields

Field	Option	Description
Manufacturer	Selectable list	The brand of the instrument.
Model	Selectable list	The instrument model.
Connect using	Cable, Bluetooth, Long-range TS or External radio CTR20 expansion pack	How the instrument is connected. The options available depend on the selection for Model . The CTR20 can only be used on the field controller. To connect a field controller with CTR20 attached to a TS with RH17/TCPS30 attached.  Offline configuration is possible if a Bluetooth address is known.

Next step

Next changes to the next panel.

14.2

Connection Using Cable

Description

The connection settings must be specified.

TS Connection Wizard - Step 2

TS Connection Wizard

Ensure the same settings are made on the total station

Baud rate: 115200

Parity: None

Data bits: 8

Stop bit: 1

Flow control: None

Back Default Next

Key	Description
Back	To return to the previous panel.
Default	To return the fields back to their default values.
Next	To confirm the settings and to continue to the next panel.

Description of fields

Field	Option	Description
Baud rate	From 1200 to 115200	Frequency of data transfer from instrument to device in bits per second.
Parity	None, Even or Odd	Error checksum at the end of a block of digital data.
Data bits	6, 7 or 8	Number of bits in a block of digital data.
Stop bit	1 or 2	Number of bits at the end of a block of digital data.
Flow control	None or RTS/CTS	Activates hardware handshake. When the instrument/device is ready for data, it asserts the Ready To Send line indicating it is ready to receive data. This line is read by the sender at the Clear To Send input, indicating it is clear to send the data.

Next step

Next and follow the instructions on the panel.

14.3

Connection Using Bluetooth

Description

The panel shown depends on whether a last used Bluetooth ID is available for the chosen instrument model.

TS Connection Wizard - Step 2

This panel is displayed if the chosen instrument model has a previously used Bluetooth ID already stored.

For a CTR20 connection, the last total station with RH17/TCPS30 which was connected is displayed.

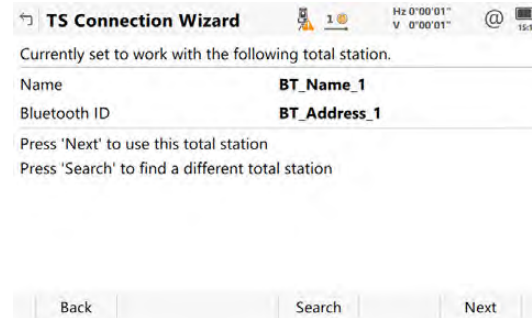

Key	Description
Back	To return to the previous panel.
Search	To search for a different total station. For a CTR20 connection also: To check if the radio used for the connection was changed.
Next	To confirm the settings and to continue to the next panel.

Next step

Follow the instructions on the panel.

Connect to Total Station - Step 2

This panel is displayed if the chosen instrument model has NO previous used Bluetooth ID already stored.

Move the focus using the arrow keys or the stylus to select a Bluetooth device.

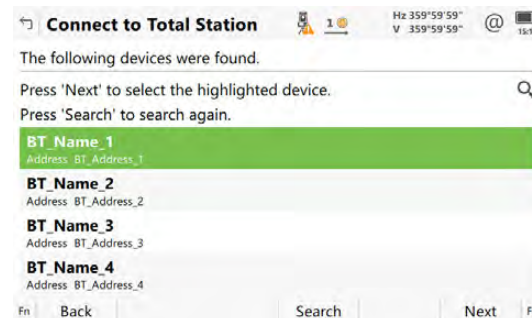

Key	Description
Next	To connect to the selected device and continue to the next panel.
Search	To search for a different total station.
Back	To return to the previous panel.

Next step

Follow the instructions on the panel.

14.4

Connection Using Internal Radio

TS Connection Wizard - Step 2

Description of fields

Field	Option	Description
Link number	Editable field	The assigned channel number.
Set as	Remote or Base	 The radio modules inside the field controller and the TS instrument must be set to opposite settings. Set the field controller to Remote and TS instrument to Base .

Next step

Next and follow the instructions on the panel.

14.5

Connection To Leica Legacy and Third Party Total Stations



Once you begin working with the CS always work on the controller! Do not touch the total station software, excluding turning the laser pointer, laser plummet or guide lights on/off for some models.



Refer to "33.7 Connection to Other Total Stations" for supported functions.

Settings required

Before using any Leica Legacy or third-party total station, ensure that the following values are set on the **TS**:

Instrument	Settings
Leica Legacy total station	<ol style="list-style-type: none">Total station ppm/scale:<ul style="list-style-type: none">Atmospheric ppm = 0Geometric ppm = 0 or scale factor = 1These settings ensure that the correct coordinates are calculated at the CS. It is still possible to apply the relevant atmospheric and geometric ppm/scale factor values. These values must then be set on the CS.Communication settings:<ul style="list-style-type: none">The communication settings on the TS must match the default parameters for that particular instrument type as seen on the CS.For TPS1000 and TPS1100 instruments:<ul style="list-style-type: none">set the communication mode to GSIensure the TS is in the measurement panel when trying to connect.

Instrument	Settings
Third-party total station - Topcon	<ol style="list-style-type: none"> 1. Total station ppm/scale: <ul style="list-style-type: none"> • Atmospheric ppm = 0 • Geometric ppm = 0 or scale factor = 1 • Prism constant = 0 (non-motorised instruments only) • The vertical angle on the total station must be set to zenith for all Topcon instruments. • The angular unit on both the total station and controller must match <p>These settings ensure that the correct coordinates are calculated at the CS. It is still possible to apply the relevant atmospheric and geometric ppm/scale factor values. These values must then be set on the CS.</p> 2. Communication settings: <ul style="list-style-type: none"> • The communication settings on the TS must match the default parameters for that particular instrument type as seen on the CS. • On motorised Topcon total stations, for example GTS800 and above, set the communication values through Prog\Ext. Link\Setting\RS232. • For non-motorised instruments, ensure that the total station is in the measurement panel when trying to connect. 3. External Link mode <ul style="list-style-type: none"> • To connect to motorised Topcon total stations, for example GTS800 and above, set the external link mode through Prog\Ext. Link\Execute. 4. Required cable: <ul style="list-style-type: none"> • TDS DB9 Data Cable (148 SCGTSSOKTOP – Topcon/Sokkia)
Third party total station - Sokkia	<ol style="list-style-type: none"> 1. Total station ppm/scale: <ul style="list-style-type: none"> • Atmospheric ppm = 0 • Geometric ppm = 0 or scale factor = 1 • Prism constant = 0 • The vertical angle display setting must be the same on the CS and the total station <p>These settings ensure that the correct coordinates are calculated at the CS. It is still possible to apply the relevant atmospheric and geometric ppm/scale factor values. These values must then be set on the CS.</p>

Instrument	Settings
	<p>2. Units:</p> <ul style="list-style-type: none"> For a Sokkia Set030R/220/010 instrument, the angle unit at the total station must be set to degrees, minutes, seconds. The angle setting at the CS does not matter. <p>3. Communication settings:</p> <ul style="list-style-type: none"> The communication settings on the TS must match the default parameters for that particular instrument type as seen on the CS. For all Sokkia instruments, ensure the TS is in the measurement panel when trying to connect. On motorised Sokkia total stations, set additional total station communication values: Comms mode: RS232C, Checksum: No and Controller: 2 Way + Remote For the Sokkia SRX set Tilt correction: No to have an uninterrupted connection. On the total station go to Settings\Obs. Condition\Tilt crn: No. <p>4. Required cable:</p> <ul style="list-style-type: none"> TDS DB9 Data Cable (148 SCGTSSOKTOP – Topcon/Sokkia)
Third party total station - Nikon	<p>1. Total station ppm/scale:</p> <ul style="list-style-type: none"> Atmospheric ppm = 0 Geometric ppm = 0 or scale factor = 1 Prism constant = 0 The angular unit on both the total station and controller must match <p>These settings ensure that the correct coordinates are calculated at the CS. It is still possible to apply the relevant atmospheric and geometric ppm/scale factor values. These values must then be set on the CS.</p> <p>2. Communication settings:</p> <ul style="list-style-type: none"> The communication settings on the TS must match the default parameters for that particular instrument type as seen on the CS. For all Nikon instruments, ensure the TS is in the measurement panel when trying to connect. <p>3. Required cable:</p> <ul style="list-style-type: none"> TDS DB9 Data Cable (148 CNTG Nikon)

15

Connections - CS connection wizard

15.1

Starting the CS Connection Wizard

Description

This chapter explains how to configure a TS to be remotely controlled from the CS.

Access

Select **Leica Captivate - Home: Settings\Connections\CS connection wizard**.

CS Connection Wizard, Which software is running on the field controller?

 A CS running Leica SmartWorx Viva cannot remote control a TS running Leica Captivate.

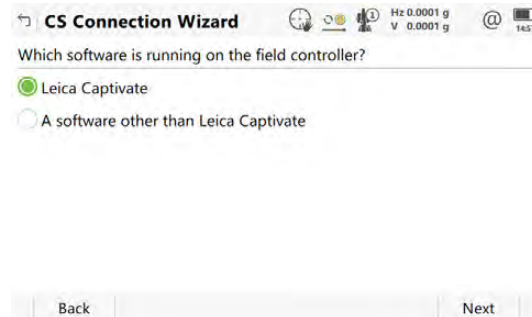

Key	Description
Back	To return to the previous panel.
Next	To confirm the settings and to continue to the next panel.

Next step

Independent of the selection made, **Next** changes to a panel where the connection type must be selected.

CS Connection Wizard, How do you want the CS controller to connect to the TS?

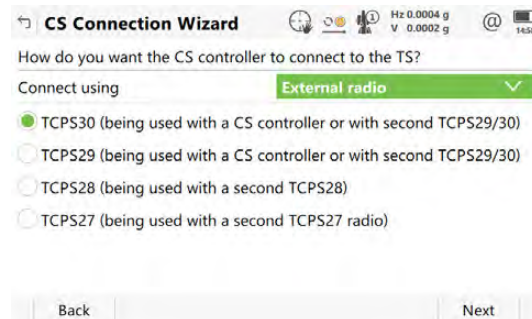

Key	Description
Back	To return to the previous panel.
Next	To confirm the settings and to continue to the next panel.

Description of fields

Field	Option	Description
Connect using		How the instrument is connected.  For CS35, only Bluetooth connections can be configured.
	Radio handle, Bluetooth, External radio	When External radio is selected, choose the type of External radio in use.
	Cable	For TS16: Serial cable connection. For MS60/TS60: USB cable connection. Select Cable for a USB cable connection. Use the cables GEV234 (LEMO - USB), GEV237 (LEMO - LEMO) or GEV261 (combined RS232/USB cable).
	Cable RS232	Available when A software other than Leica Captivate is checked in the previous panel. Available on MS60/TS60 to configure serial connection.
	WLAN	Available when A software other than Leica Captivate is checked in the previous panel. Requires settings in WinCE.

Next step

Next changes to the next panel.

IF	THEN
connected using RadioHandle	Next changes to the next panel. The RadioHandle is detected automatically, if it is plugged into the TS. The name of the RadioHandle is then displayed. If the RadioHandle is not plugged onto the TS, then select the RadioHandle which is used. Press Next .  The RH17 can only be connected to a CS20 equipped with a CTR20.
connected using TCPS27/TCPS28	Select the TCPS connected and press Next . Refer to "15.2 Connection Using TCPS".
connected using TCPS29/TCPS30	Select the TCPS connected and press Next . Further settings are not required.
connected using cable	refer to "15.3 Connection Using Cable".
a MS60/TS60 is connected using cable and Leica Captivate is running on the field controller	the system sets all the parameters to be able to connect to a CS using USB interface from port 1.

IF	THEN
a MS60/TS60 is connected using cable and a software other than Leica Captivate is running on the field controller	<ul style="list-style-type: none"> for a serial connection refer to "15.3 Connection Using Cable". for a USB connection, the system sets all the parameters to be able to connect to a CS using USB interface from port 1.
connected using Bluetooth	Next changes to the next panel. The Bluetooth connection is established automatically. Press Finish .
connected using WLAN	enable and configure WLAN within WinCE. Next changes to the next panel. Press Finish .

15.2

Connection Using TCPS

TS Connection Wizard



This panel is valid for TCPS27/TCPS28/TCPS29.

The channel on which the TCPS broadcasts can be changed. Changing channels changes the frequency at which the TCPS operates. This may be necessary to enable multiple pairs of TCPS to work simultaneously in the same area without interfering with each other.

Key	Description
Back	To return to the previous panel.
Next	To confirm the settings and to continue to the next panel.
Fn Default	To return the fields back to their default values.
Fn Save	To save the settings.

Description of fields

Field	Option	Description
Radio type	Display only	The type of protocol.
Link number	Editable field	The assigned channel number.
Set as	Remote or Base	The TCPS inside the field controller and the TS16/MS60/TS60 must be set to opposite settings. Set the field controller to Remote and TS16/MS60/TS60 to Base .

Next step

Next and follow the instructions on the panel.

15.3

Connection Using Cable

CS Connection Wizard
- Ensure the same settings are made on the CS.

Valid for TS16/MS60/TS60.

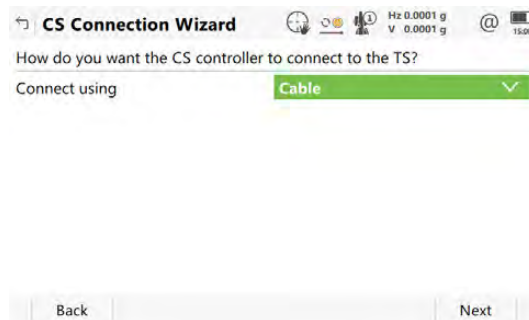

Key	Description
Back	To return to the previous panel.
Next	To confirm the settings and to continue to the next panel.
Fn Default	To return the fields back to their default values.

Description of fields

Field	Option	Description
Baud rate	From 1200 to 115200	Frequency of data transfer from instrument to device in bits per second.
Parity	None, Even or Odd	Error checksum at the end of a block of digital data.
Data bits	6, 7 or 8	Number of bits in a block of digital data.
Stop bit	1 or 2	Number of bits at the end of a block of digital data.
Flow control	None or RTS/CTS	Activates hardware handshake. When the instrument/device is ready for data, it asserts the Ready To Send line indicating it is ready to receive data. This line is read by the sender at the Clear To Send input, indicating it is clear to send the data.

Next step

Next and follow the instructions on the panel.

16

RTK rover wizard

16.1

Overview

Description

Using this wizard, the settings for a real-time rover behaviour are defined at one glance. These settings are stored in an RTK profile.

Access

Select **Leica Captivate - Home: Settings\Connections\RTK rover wizard**.



If RTK profiles exist, the wizard starts with the panel shown in this section. Otherwise, the wizard starts the process of creating a RTK profile. In this case, refer to "16.2 Creating a New RTK Profile".

For CS35: The **RTK Rover Wizard** is reduced to GS specific settings. Use Windows for all other settings required. While using the **RTK Rover Wizard**, the CS35 must physically be connected to the GS.

RTK Rover Wizard

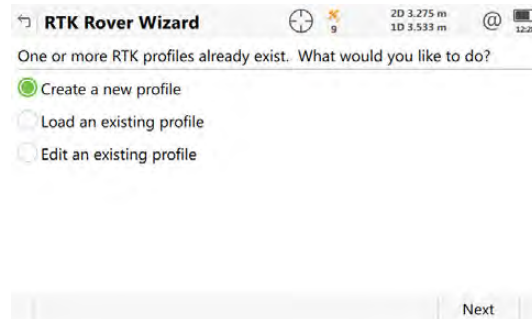

Key	Description
Next	To accept changes and to continue with the subsequent panel within the wizard.

Next step

IF you want to	THEN
create a set of settings	select Create a new profile , press Next and continue with "16.2 Creating a New RTK Profile".
select a different set of settings	select Load an existing profile , press Next and continue with "16.3 Loading an Existing RTK Profile".
edit an existing set of settings	select Edit an existing profile , press Next and continue with "16.4 Editing an Existing RTK Profile".

16.2

Creating a New RTK Profile

RTK Rover Wizard,
Enter a name for the
new RTK profile

Type in the name and a description for the new set of settings.

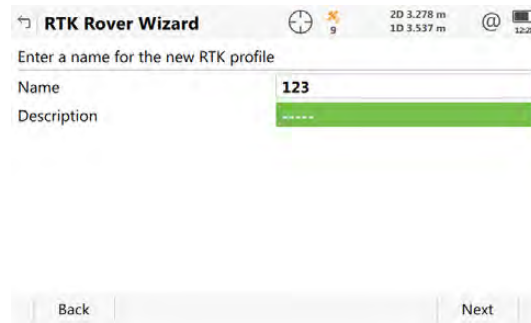

Key	Description
Back	To return to the previous panel.
Next	To accept changes and to continue with the subsequent panel within the wizard.

16.3

Loading an Existing RTK Profile

RTK Rover Wizard,
Choose an RTK profile

Select an existing RTK profile from the selectable list. Listed are profiles that match the instrument in use.



Key	Description
Back	To return to the previous panel.
Delete	Pressing this key deletes the RTK profile currently shown in the selectable list.
Finish	To accept changes and to return to Leica Captivate - Home .

16.4

Editing an Existing RTK Profile

RTK Rover Wizard, Choose an RTK profile

Select the RTK profile to be edited from the selectable list. Listed are profiles that match the instrument in use.

RTK Rover Wizard 2D 3.280 m 1D 3.539 m @ 12:28

Choose an RTK profile

RTK profile 123

Connection type Radio

Create a copy

Back Delete Next

Key	Description
Back	To return to the previous panel.
Delete	Pressing this key deletes the RTK profile currently shown in the selectable list.
Next	To accept changes and to continue with the subsequent panel within the wizard.

Description of fields

Field	Option	Description
Create a copy	Check box	Creates a copy before the editing process starts.

Description

This chapter explains how the field controller can be connected to the Internet using a wizard and without using RTK.

Access

Select **Leica Captivate - Home: Settings\Connections\Internet wizard**.



For CS35, **Internet wizard** is unavailable. Use Windows to configure an Internet connection.

The panel displayed varies.

IF	AND	THEN
the Internet wizard is started for the first time	a CS is used	the Internet device can be connected to the <ul style="list-style-type: none"> • CS 3.5G modem port • Bluetooth mobile phone
	a TS16/MS60/TS60 is used	the Internet device can be connected to a Bluetooth phone of type <ul style="list-style-type: none"> • GSM/UMTS/LTE device • CDMA device
the Internet connection is configured	not connected	<ul style="list-style-type: none"> • the Internet connection can be edited. • the connection can be started.
the Internet connection is configured	connected	<ul style="list-style-type: none"> • the Internet connection can be edited. • the connection can be stopped.

Next step

Make a selection, press **Next** and follow the instructions on the panel.

18

Connections - All other connections

18.1

Accessing Configuration Connections

Description

The instrument has various connections which can be configured to be used with different ports and devices.

Access

Select **Leica Captivate - Home: Settings\Connections\All other connections**.

Connection Settings

The panel gives an overview of all connections with the currently assigned port and device.

For an RTK rover, this panel consists of the **CS connections** and the **GS connections** page.

For a GS08plus, this panel consists of only one page.



For CS35, only **GS rover** and **Total station** connections can be configured.

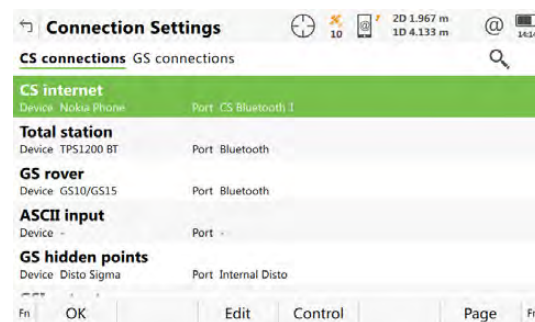

Key	Description
OK	To return to the panel from where this panel was accessed.
Edit	To configure the parameters related to the highlighted connection. Refer to the sections on each individual connection in this chapter.
Control	Available for certain devices connected to certain connections. To configure more parameters related to the highlighted device. For MS60/TS60: Available when the GeoCOM connection is set to Cable (USB) and WLAN . To show the IP and the port for Third-party connections.
Fn Connect and Fn Disconnect	Available for a real-time connection configured to use an Internet connection. To connect/disconnect from the GNSS reference data.

18.2

CS internet / GS internet / TS Internet

18.2.1

Leica Captivate

Description

The Internet connection

- allows accessing the Internet using the field controller (CS internal phone modem) or the instrument plus a phone modem device.
- can be used together with the real-time connection to receive real-time data from, for example, a Ntrip Caster using Internet communication.

Refer to "34 NTRIP via Internet" for information about Ntrip.

The settings on this panel define the port and parameters required for accessing the Internet.

Access

For CS:

- In **Connection Settings, CS connections** page, highlight **CS internet. Edit.**

For CS - GS rover:

- In **Connection Settings, GS connections** page, highlight **GS internet. Edit.**

For CS - GS base:

- In **Base Connection Settings**, select **GS internet. Edit.**

For TS:

- In **Connection Settings**, highlight **TS Internet. Edit.**

For CS35:

- Use Win8 to configure an Internet connection.

For TS with GS:

- In **Connection Settings, TS connections** page, highlight **TS Internet. Edit.**
- In **Connection Settings, GS connections** page, highlight **GS internet. Edit.**

Internet Connection, Internet page

Key	Description
OK	To accept changes and return to the panel from where this panel was accessed.
Search	To search for all available Bluetooth devices. If more than one Bluetooth device is found a list of available devices is provided. Available if CS Bluetooth 1 or CS Bluetooth 2 are selected.
Device	To create, select, edit or delete a device. Refer to "18.1 Accessing Configuration Connections". Available if Use Internet connection on CS/Use Internet connection on GS/Use Internet connection on TS is checked.

Key	Description
Page	To change to another page on this panel. Available if Use Internet connection on CS/Use Internet connection on GS/Use Internet connection on TS is checked.

Description of fields

Field	Option	Description
Use Internet connection on CS, Use Internet connection on GS or Use Internet connection on TS	Check box	Activates the Internet connection.
Connect using		The ports available for connection to the Internet.
	CS modem	The internal GSM modem of the field controller.
	CS RS232 port	The RS232 port on the field controller.
	CS Bluetooth 1 and CS Bluetooth 2	The Bluetooth ports on the field controller which are used for the connection functionality.
	CS modem	
	GS Port 1	For GS10/GS25: The physical port P1 on the box. For GS15: The red LEMO port.
	GS Port 2	For GS10/GS25: The physical port P2 on the box. For GS15: The black LEMO port.
	GS Port 3	For GS10: The physical port P3 on the box. For GS15/GS25: The port for the slot devices.
	GS Port 4	For GS25: The physical port P4 on the box.
	TS Bluetooth 1 and TS Bluetooth 2	The Bluetooth ports on the TS16 which is used for the connection functionality.
Device	Display only	The name of the selected device.
Use user ID & password	Check box	If checked, a user ID and a password can be typed in.
User ID	Editable field	Some providers ask for a user ID to allow connecting to the Internet using GPRS. Contact your provider if a user ID must be used. It is possible to show/hide the User ID.

Field	Option	Description
Password	Editable field	Some providers ask for a password to allow connecting to the Internet using GPRS. Contact your provider if a password is required.
Display password	Check box	When this box is checked, the password is displayed in the Password field. When this box is not checked, dots are displayed in the Password field.



Next step

Page changes to the **Advanced** page.

Internet Connection, Advanced page

Description of fields

Field	Option	Description
Use static IP address	Check box	<p>In order to get access to the Internet, an IP address is required. This IP address identifies the instrument in the Internet. This option should only be checked if a static IP address is available for the instrument.</p> <p>The IP address to get access to the Internet is provided by the network provider permanently. Each time the instrument wants to access the Internet using the device the same IP address identifies the instrument. This behaviour is important if the instrument is used as a TCP/IP server.</p>
IP address	Editable field	Available if Use static IP address is checked. To set the IP address.
Use DynDNS	Check box	<p>Available for GS internet connection on the base.</p> <p>To configure a dynamic DNS service. This setting provides access to the RTK data stream of a GS base server while it is using a dynamic IP address. The setting allows TCP/IP clients to use an Internet domain name to address a GS with a dynamic IP address.</p> <p>Use case: A GS is set up in base mode with an Internet connection using GPRS. The GS has a different IP address every time the Internet connection is established or after running for a certain time. The GS checks every 12 min if its IP address has changed. If so, the GS updates the DynDNS settings.</p> <p>Refer to 18.2.2 DynDNS for more information about DynDNS.</p>

Field	Option	Description
Service provider	Selectable list	Available when Use DynDNS is checked. Select the DNS service to use.  Register at the selected DynDNS service to receive a user name and password and to create a host name.
Host name	Editable field	Available when Use DynDNS is checked. Type in the host name that you created at the DynDNS service where you registered.  Rovers can resolve host names. Using DynDNS is an easy way to provide RTK data from an instrument without having to know the current IP address.
User name	Editable field	Available when Use DynDNS is checked. Type in the user name provided by the DynDNS service where you registered.
Password	Editable field	Available when Use DynDNS is checked. Type in the password provided by the DynDNS service where you registered.
Display password	Check box	When this box is checked, the password is displayed in the Password field. When this box is not checked, dots are displayed in the Password field

Next step

OK returns to the panel from where **Internet Connection** was accessed.

18.2.2

DynDNS

Usage with dynamic IP address

Goal

To access a GS with a dynamic IP address using a host name.

Basic concept of dynamic DNS (DynDNS)

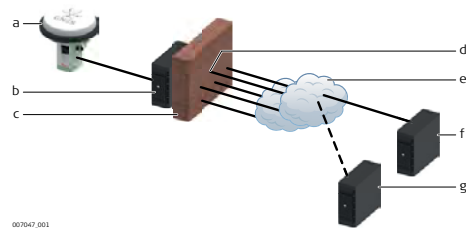

- a GS with mobile Internet device
- b ISP with DNS server
- c Firewall
- d Port 8245 or 80
- e Internet
- f checkip.dyndns.org
- g dyndns.com

- When using a mobile Internet connection, be aware of two types of restrictions:

1. The first restriction is on the outgoing ports. When the GS is trying to access checkip.dyndns.org it uses port 8245. For using two-dns.de, an alternative to DynDNS.com, port 80 is needed additionally. It is important that ports 8245 and possibly 80 are open for outgoing connections, depending on which service you use.
 2. The second restriction is for incoming connections. If you managed to connect to DynDNS.com and associate your IP address with your host-name, you could theoretically connect to it using the hostname. In practise, you can run into the problem of ports not being open.
- Most likely your ISP has closed the standard ports - port 80 for web interface access or port 21 for FTP access.
In order to access the Internet with a mobile device/SIM card, you need an **Access Point Name**, a user name and a password and a list of open incoming ports.
Imagine this APN like a subnet for your phone that your ISP can configure, for example what external networks, services, open ports are available. Usually when you use mobile devices/SIM cards from the same ISP, the APN is the same for all these devices.
The open ports you can use when providing RTK data from your GS are defined by this APN profile. This means besides the APN, user name and password, you must also ask your ISP for a list of open ports. These open ports can then be configured on the GS for the **Base RTK 1** and **Base RTK 2** interface. All other ports on the GS cannot be configured/changed.



Ask for a list of open ports for the APN you want to use before configuring your DynDNS setup.

Configuring mobile Internet and DynDNS step-by-step

1. Contact your Internet service provider and ask for the APN profile for your mobile device/SIM card. You receive a document listing all open ports for your APN.
2. Register at the DynDNS service of your choice.
Create:
 - A user name and password for your DynDNS account.
 - A host name for the GS.
3. Select **Leica Captivate - Base\Settings\Connections\All other connections**.
4. Highlight **GS internet** and press **Edit**.
5. On the **Internet** page, check **Use Internet connection on GS**.
Select the mobile device to use.
6. On the **Advanced** page, check **Use DynDNS**.
Select the **Service provider**.
Enter **Host name**, **User name** and **Password**.
7. To see the details about your mobile Internet connection:
Tap on @ in the icon bar. Select **Internet status**.
The last updated IP address is displayed.
8. Select **Leica Captivate - Base\Settings\Connections\All other connections**.
9. Highlight **Base RTK 1** and press **Edit**.
10. Configure the transmission of RTK correction data and press **OK**.
11. Press **Control**.

12. Configure **User type: Server**. Make sure the TCP/IP port is set to a port listed as open in your APN profile. Configure, how many clients can connect to this port simultaneously to allow up to ten rovers to connect to a base RTK port.
13. You can now receive RTK correction data from your base using the host name and the configured RTK port.

Troubleshooting

- Tap on @ in the icon bar. Select **Internet status**. Check that DynDNS status is shown as **On**. Check that the currently registered IP address is correct.
- Everything is fine, but you do not get data from the port that you configured for your data stream? Use the DynDNS tool <http://www.dyndns.com/support/tools/openport.html> and enter the IP address of your GS. You can find the IP address as described above. Enter the port you are trying to connect to. The tool tells you if this port is open. If not, change your data stream setting to a different port.

18.3

GS rover / GS base

Description

To connect the field controller to the sensor (antenna) either on the base or on the rover side.



For CS35, the setting for **Sensor** can be selected. Only Bluetooth connections can be used. The Bluetooth connection itself must be configured in Windows.

Access

For RTK rover:

- In **Connection Settings, CS connections** page, highlight **GS rover. Edit**.

For RTK base:

- In **Base Connection Settings**, select **GS base. Edit**.

Connect to GS Rover / Connect to GS Base

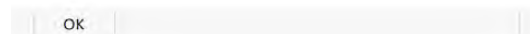

Key	Description
OK	To accept changes and return to the panel from where this panel was accessed. When you change the sensor type, shut down Leica Captivate. Restart Leica Captivate before using the sensor.
Search	To search for all available Bluetooth devices. If more than one Bluetooth device is found a list of available devices is provided. Available for GS with Connect using: Bluetooth .

Description of fields

Field	Option	Description
Sensor	Selectable list	Select the attached model.
Connect using	Cable or Bluetooth	How the instrument is connected. The options available depend on the selection for Sensor . The availability of the other fields depends on the selection made here.  For CS35: Only Bluetooth connections can be used. Use Windows to configure the Bluetooth connection.
Last used rover	Display only	Available for RTK rover. The name of the selected Bluetooth device.
Last used base	Display only	Available for RTK base. The name of the selected Bluetooth device.
Bluetooth ID	Display only	The ID of the selected Bluetooth device.

18.4

ASCII input

18.4.1

Configuration of an ASCII Input Connection

Description

The ASCII Input connection receives ASCII messages from third-party devices such as depth sounders, barometers, digital cameras, pipe detectors, Geiger counters. The ASCII messages are stored as annotations together with the next manually measured point and/or auto point.

The settings on this panel define the port and the device to be used and the type of ASCII messages to be written to individual annotations.

Access

For RTK rover:

- In **Connection Settings, CS connections** page, highlight **ASCII input. Edit.**

For CS35:

- Unavailable. Use Windows to configure a connection.

ASCII Input, ASCII input page

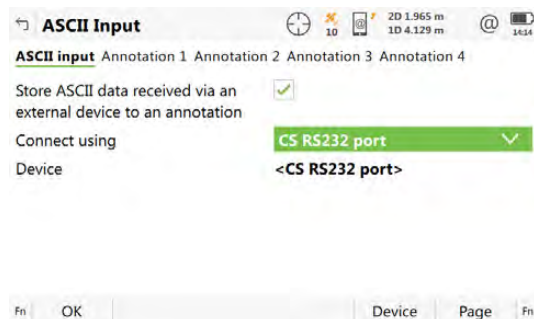

Key	Description
OK	To accept changes and return to the panel from where this panel was accessed.

Key	Description
Device	Available when Store ASCII data received via an external device to an annotation is checked. To create, select, edit or delete a device. Refer to "20.2 Accessing Devices".
Page	To change to another page on this panel.
Fn Command	To configure a message to be sent through the configured port to the device.

Description of fields

Field	Option	Description
Store ASCII data received via an external device to an annotation	Check box	Activates the ASCII input connection.
Connect using	CS Bluetooth 1 and CS Bluetooth 2 CS RS232 port	The Bluetooth ports on the field controller which are used for the connection functionality. The RS232 port on the field controller.
Device	Display only	The name of the device selected for ASCII input.

Next step

Page changes to the **Annotation 1/Annotation 2/Annotation 3/Annotation 4** page.

ASCII Input,
Annotation 1/
Annotation 2/
Annotation 3/
Annotation 4page

Description of fields

Field	Option	Description
Store ASCII data to this annotation	Check box	If checked, ASCII messages are recorded with the selected annotation.
Message desc	Editable field	The description for the ASCII message being received. This description is then displayed in other panels.
Message ID	Display only	The message ID to identify a particular ASCII message coming from the device. The message is then saved to the annotation. The following characters can be used as filter: ^ To accept strings starting with the subsequent characters. For example, ^1 accepts 12 but not 21. \$ To accept strings ending with the preceding characters. For example, 1\$ accepts 21 but not 12. . To accept any character except newline.

Field	Option	Description
		[] To accept a set of characters. For example, [0-9] accepts all numbers. Any characters to accept strings that include the characters at any position. For example 1 accepts 1234, 4321 or 2134 but not 2345.
Prefix when writing	Check box	Stores the description in Message desc as prefix to the ASCII message. This prefix helps to more easily identify the annotations registered with a point.

Next step

Page changes to another page on this panel.

18.4.2

Configuration of a Command to the Device

Access

For RTK rover:

- In **ASCII Input, ASCII input** page, **Fn Command**.

Send Command to Device

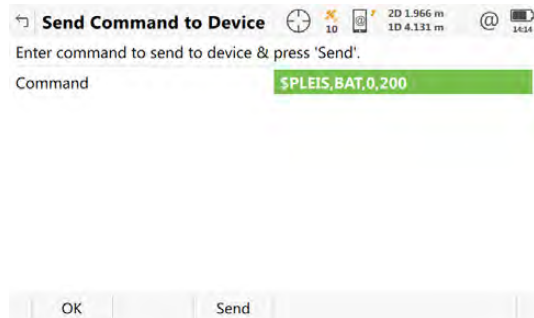

Key	Description
OK	To accept changes and return to the panel from where this panel was accessed.
Send	To send the command to the device.

Description of fields

Field	Option	Description
Command	Editable field	A message to be sent to the device through the configured port when the Measure or stake app is accessed. This functionality, for example, allows the device to be started remotely. The last used command that was entered is remembered as part of the active working style.

18.5

Hidden point

Description

Hidden point measurement devices are used for measuring to points which cannot be directly measured with GNSS, for example house corners or trees. The measurements made with a hidden point measurement device are directly

transferred to the instrument for the calculation of the coordinates of the hidden point. They can also be entered manually.

The settings on this panel define the port, the device and estimated qualities to be used for the hidden point connection.

Access

For RTK rover:

- In **Connection Settings, CS connections** page, highlight **Hidden point. Edit.**

For CS35:

- Unavailable. Use Windows to configure a connection.

Hidden Point

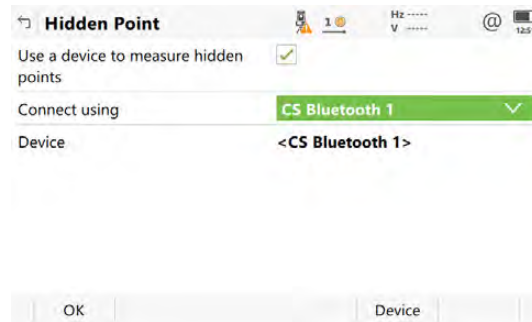

Key	Description
OK	To accept changes and return to the panel from where this panel was accessed.
Search	Available when a Bluetooth port and device is selected. To search for all available Bluetooth devices. If more than one Bluetooth device is found a list of available devices is provided.
Device	To create, select, edit or delete a device. Refer to "20.2 Accessing Devices".

Description of fields

Field	Option	Description
Use a device to measure hidden points	Check box	To compute a hidden point with height. Activates the hidden point connection. If not checked, the measured values must be entered manually.
Connect using	CS Bluetooth 1 and CS Bluetooth 2	The Bluetooth ports on the field controller which are used for the connection functionality.
	CS RS232 port	The RS232 port on the field controller.
	Internal Disto	The DISTO in the CS20.
Device	Display only	The name of the selected hidden point device.

Field	Option	Description
Bluetooth ID	Display only	Available if CS Bluetooth 1 or CS Bluetooth 2 are selected. The Bluetooth ID of the hidden point device.

Diagram

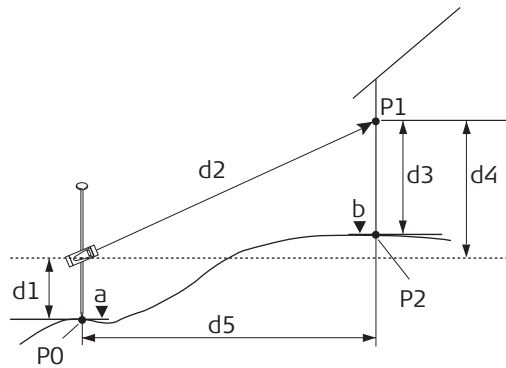

GS_052

- P0 Known point
- P1 Target point
- P2 Hidden point
- a Height of P0
- b Height of P2 = $a + d1 + d4 - d3$
- d1 Device height: height of hidden point measurement device above P0
- d2 Slope distance
- d3 Device height: height of P1 above P2
- d4 Height difference between hidden point measurement device and P1
- d5 Horizontal distance

Distance offsets at hidden point measurement devices

A Leica DISTO is shown as an example

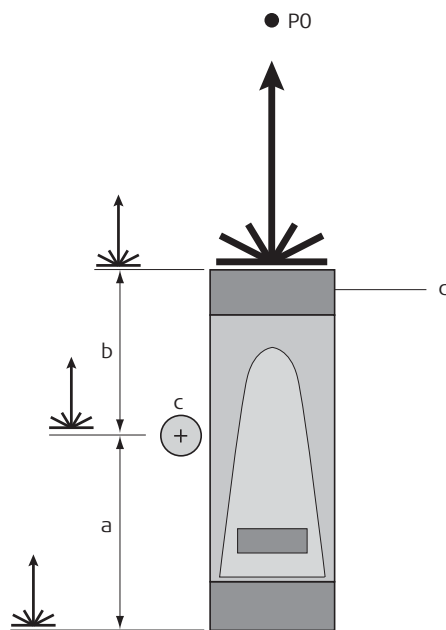

GS_053

- a) Negative **Distance offset**
- b) Positive **Distance offset**
- c) Pole
- d) DISTO
- P0 Hidden point

Description

The Export Job connection allows data from a job to be exported from the instrument to another instrument.

The settings on this panel define the port and the device to which the data is exported.

Access

For RTK rover:

- In **Connection Settings, CS connections** page, highlight **Export job. Edit.**

For TS:

- In **Connection Settings** highlight **Export job. Edit.**

For CS35:

- Unavailable. Use Windows to configure a connection.

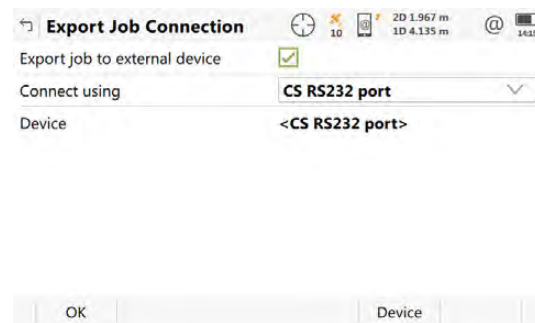
Export Job Connection

Key	Description
OK	To accept changes and return to the panel from where this panel was accessed.
Search	Available when CS Bluetooth 1 or CS Bluetooth 2 are selected. To search for all available Bluetooth devices. If more than one Bluetooth device is found a list of available devices is provided.
Device	To create, select, edit or delete a device. Refer to "20.2 Accessing Devices".

Description of fields

Field	Option	Description
Export job to external device	Check box	Activates the connection.
Connect using	CS Bluetooth 1 / CS Bluetooth 2 or TS Bluetooth 1 / TS Bluetooth 2	The Bluetooth ports on the field controller or the TS which are used for the connection functionality.

Field	Option	Description
	CS RS232 port or Cable	The RS232 port on the field controller or the TS.
	Radio handle	Hotshoe connection for RadioHandle. This port is on top of Communication side cover.
Device	Display only	The device currently assigned to the selected port within the active working style. The device which is selected determines the availability of the next fields.

18.7

RTK rover

18.7.1

Configuration of a Rover Real-Time Connection

Description

The real-time connection allows real-time related parameters to be configured. These parameters include defining the real-time messages and the base to be used.

Access

For RTK rover:

- In **Connection Settings, GS connections** page, highlight **RTK rover. Edit.**

RTK Rover Settings, General page

The available fields and keys on this panel depend on the selected settings.

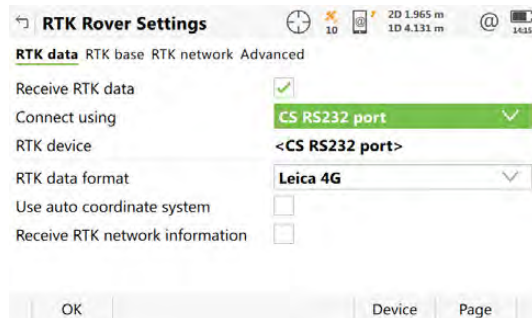

Key	Description
OK	To accept changes and return to the panel from where this panel was accessed.
Search	Available when connecting using Bluetooth. To search for all available Bluetooth devices. If more than one Bluetooth device is found a list of available devices is provided.
Device	To create, select, edit or delete a device. Refer to "20.2 Accessing Devices".  For CS35: Configure Bluetooth mobile phones and short range Bluetooth for TS applications in Windows.
Page	To change to another page on this panel.

Description of fields

Field	Option	Description
Receive RTK data	Check box	If checked, the rover real-time connection is activated.
Connect using	CS modem	The internal GSM modem of the field controller.
	CS RS232 port	The RS232 port on the field controller. Unavailable for GS08plus.
	CS Bluetooth 1 and CS Bluetooth 2	The Bluetooth ports on the field controller used for the connection.  For CS35, only Bluetooth connections are configurable.
	CS Internet 1, CS Internet 2 and CS Internet 3	The Internet ports on the field controller. If these ports are not assigned to a specific connection, then these ports are extra remote ports.
	GS Port 1	For GS10: The physical port P1 on the box. For GS14/GS15/GS16/GS18: The red LEMO port. For GS25: The physical LEMO port P1 on the box.
	GS Port 2	For GS10: The physical port P2 on the box. For GS15: The black LEMO port. For GS25: The physical LEMO port P2 on the box.
	GS Port 3	For GS10: The physical port P3 on the box.
	GS Port 4	For GS25: The physical LEMO port P4 on the box.
	GS modem	The internal GSM modem of the GS14/GS16.
	GS Internet 1, GS Internet 2 and GS Internet 3	The Internet ports on the GS. If these ports are not assigned to a specific connection, then these ports are extra remote ports.
TS Bluetooth 1 and TS Bluetooth 2	TS Bluetooth 1 and TS Bluetooth 2	The Bluetooth ports on the TS which are used for the connection functionality.
	TS Internet 1, TS Internet 2 and TS Internet 3	The Internet ports on the TS. If these ports are not assigned to a specific connection, then these ports are extra remote ports.
	CS CGR radio	The CGR20 that can be attached to the CS20.

Field	Option	Description
RTK device	Display only	The device currently assigned to the selected port within the active working style. The device which is selected determines the availability of the next fields.
RTK data format		<p> If a mountpoint was selected from a downloaded source table during the use of the RTK connection wizard, then the RTK format which is used with the NTRIP mountpoint is displayed.</p> <p>Leica 4G The proprietary Leica real-time GNSS data format supporting GPS L1/ L2/ L5, GLONASS L1/L2, Galileo E1/E5a/E5b/AltBOC and BeiDou B1/B2. This format is recommended when working exclusively with Leica instruments.</p> <p>Leica The proprietary Leica real-time GNSS data format supporting GPS L1/L2 and GLONASS L1/L2. This format is recommended when working exclusively with Leica instruments.</p> <p>CMR/CMR+ CMR and CMR+ are compacted formats used to broadcast data for third-party instruments.</p> <p>RTCM 18,19 v2 Message according to RTCM version 2.x. Uncorrected carrier phase and pseudorange. Message 3 is also generated. Use for real-time operations where the ambiguities are resolved at the rover. Accuracy at the rover: 1 - 5 cm rms after a successful ambiguity resolution.</p> <p>RTCM v3 Use RTCM when rover units from a different manufacturer are used. Use to decode the standard RTCM v3 and the RTCM v3 (MSM) messages from the base. Message according to RTCM version 3. A new standard format for transmission of Global Navigation Satellite System correction information. Higher efficiency than RTCM v2.x. Supports real-time services with reduced bandwidth.</p> <p>Message types for real-time GNSS operation:</p> <ul style="list-style-type: none"> • 1001: L1-only GPS real-time observables • 1002: Extended L1-only GPS real-time observables • 1003: L1 & L2 GPS real-time observables • 1004: Extended L1 & L2 GPS real-time observables • 1005: Stationary real-time base station Antenna Reference Point

Field	Option	Description
		<ul style="list-style-type: none"> • 1006: Stationary real-time base station ARP with antenna height • 1007: Antenna descriptor • 1008: Antenna descriptor and serial number • 1009: L1-only GLONASS real-time observables • 1010: Extended L1-only GLONASS real-time observables • 1011: L1 & L2 GLONASS real-time observables • 1012: Extended L1 & L2 GLONASS real-time observables
		<p>Network RTK Messages according to Master-Auxiliary Concept:</p> <ul style="list-style-type: none"> • 1014: Network Auxiliary Station Data message. This message contains details of the base stations in the network. For example, the master station and its coordinates, and the coordinate differences between the master and its auxiliaries. • 1015: Ionospheric Correction Differences message • 1016: Geometric Correction Differences message • 1021: Helmert/Abridged Molodensky transformation • 1022: Molodensky-Badekas transformation • 1023: Transformation Residual Message, ellipsoidal grid representation; CSCS/position & geoid/height residuals are supported • 1024: Transformation Residual Message, plane grid representation; CSCS/position & geoid/height residuals are supported • 1025: Projection types except LCC2SP, OM • 1026: Projection type Lambert Conic Conformal (LCC2SP) • 1027: Projection type Oblique Mercator (OM) • 1029: Unicode Text String message • 1032: Physical Reference Station Position message • 1033: Receiver and Antenna Descriptor message

Field	Option	Description
		<ul style="list-style-type: none"> • 1037: GLONASS Ionospheric Correction Differences message (phase). • 1038: GLONASS Geometric Correction Differences message (phase). • 1039: GLONASS Combined Geometric and Ionospheric Correction Differences message (phase). • 1068: GLONASS Ionospheric Correction Differences message (code). • 1069: GLONASS Geometric Correction Differences message (code). • 1070: GLONASS Combined Geometric and Ionospheric Correction Differences message (code). • 1230: GLONASS biases
		<p>Pseudorange and phase range values for L1 and L2. Depending on the type of instrument, the data for L1-only or for L1 and L2 are sent out.</p> <p>Message types for universal real-time GNSS operation, decoding from : RTCM v3 (MSM)</p> <p>The receiver can decode RTCM v3 (MSM).</p>
		<ul style="list-style-type: none"> • 1071: Compact GPS pseudo ranges (MSM1) • 1072: Compact GPS phase ranges (MSM2) • 1073: Compact GPS pseudo ranges and phase ranges (MSM3) • 1074: Full GPS pseudo ranges and phase ranges plus Carrier-to-Noise Ratio (MSM4) • 1075: Full GPS pseudo ranges, phase range, phase range rate and CNR (MSM5) • 1076: Full GPS pseudo ranges and phase ranges plus CNR, high resolution (MSM6) • 1077: Full GPS pseudo ranges, phase ranges, phase range rates and CNR, high resolution (MSM7) • 1081: Compact GLONASS pseudo ranges (MSM1) • 1082: Compact GLONASS phase ranges (MSM2) • 1083: Compact GLONASS pseudo ranges and phase ranges (MSM3) • 1084: Full GLONASS pseudo ranges and phase ranges plus CNR (MSM4)

Field	Option	Description
		<ul style="list-style-type: none"> • 1085: Full GLONASS pseudo ranges, phase ranges, phase range rates and CNR (MSM5) • 1086: Full GLONASS pseudo ranges and phase ranges plus CNR, high resolution (MSM6) • 1087: Full GLONASS pseudo ranges, phase ranges, phase range rates and CNR, high resolution (MSM7) • 1091: Compact Galileo pseudo ranges (MSM1) • 1092: Compact Galileo phase ranges (MSM2) • 1093: Compact Galileo pseudo ranges and phase ranges (MSM3) • 1094: Full Galileo pseudo ranges and phase ranges plus CNR (MSM4) • 1095: Full Galileo pseudo ranges, phase ranges, phase range rates and CNR (MSM5) • 1096: Full Galileo pseudo ranges and phase ranges plus CNR, high resolution (MSM6) • 1097: Full Galileo pseudo ranges, phase ranges, phase range rates and CNR, high resolution (MSM7) • 1121: Compact BeiDou pseudo ranges (MSM1) • 1122: Compact BeiDou phase ranges (MSM2) • 1123: Compact BeiDou pseudo ranges and phase ranges (MSM3) • 1124: Full BeiDou pseudo ranges and phase ranges plus CNR (MSM4) • 1125: Full BeiDou pseudo ranges, phase ranges, phase range rates and CNR (MSM5) • 1126: Full BeiDou pseudo ranges and phase ranges plus CNR, high resolution (MSM6) • 1127: Full BeiDou pseudo ranges, phase ranges, phase range rates and CNR, high resolution (MSM7)
		<p>Accuracy at the rover:</p> <ul style="list-style-type: none"> • For L1-only: 0.25-1m rms. • For L1 and L2: 1-5cm rms after a successful ambiguity resolution.

Field	Option	Description
	RTCM 1,2 v2	Message according to RTCM version 2.x. Differential and delta differential GPS corrections. Message 3 is also generated. Use for DGPS. Accuracy at the rover: 0.25-1m rms.
	RTCM 9,2 v2	Message according to RTCM version 2.x. GPS partial correction set and delta differential GPS corrections. Message 3 is also generated. Use for DGPS with a slow data channel in the presence of interference. Accuracy at the rover: 0.25-1m rms.
	RTCM 20,21 v2	Message according to RTCM version 2.x. Real-time carrier phase corrections and high accuracy pseudorange corrections. Message 3 is also generated. Use for real-time operations. Accuracy at the rover: 1-5cm rms after a successful ambiguity resolution.
	RTCM 1,2,18,19 v2	Available for RTK base. Message according to RTCM version 2.x. Combination of RTCM 1,2 v2 and RTCM 18,19 v2 .
	RTCM 1,2,20,21 v2	Available for RTK base. Message according to RTCM version 2.x. Combination of RTCM 1,2 v2 and RTCM 20,21 v2 .
	The availability of the following options, depends on the selection made for SBAS tracking on the Advanced page.	
	Automatic SBAS	SBAS satellites are tracked and the SBAS service used is automatically selected.
	WAAS	Wide Area Augmentation System satellites are tracked.
	EGNOS	European Geostationary Navigation Overlay System satellites are tracked.
	MSAS	MTSAT Satellite-based Augmentation System where MTSAT stands for Multi-functional Transport SATellite
	GAGAN	GPS Aided Geo Augmentation Navigation satellites are tracked.
RTCM version	1.x, 2.1, 2.2 or 2.3	Available when the selected RTK data format is an RTCM version 2 format. The same version must be used at the reference and the rover.
Bits per byte	6 or 8	Defines the number of bits/byte in the RTCM message being received.
Use auto coordinate system	Check box	Available for RTK data format: RTCM v3 or Leica 4G . To set an RTCM coordinate system received by a reference network as active coordinate system.
Receive RTK network information	Check box	Available for RTK data format: RTCM v3 or Leica 4G . Activates an info message (RTCM message 1029).

Field	Option	Description
Behaviour	Selectable list	Available when Receive RTK network information is checked.
	Log only	The info message is logged to a text file.
	Show only	The info message is shown by the instrument.
	Show & log	The info message is shown by the instrument and logged to a text file.

Next step

Page changes to the **RTK base** page.

RTK Rover Settings, RTK base page

Description of fields

Field	Option	Description
Sensor at base	Selectable list	The instrument type used at the base. If the real-time data format contains information of the instrument type, certain corrections based on this information are applied in order to provide correct results. The real-time data formats Leica , Leica 4G , CMR/CMR+ and RTCM v3 contain this information. These corrections are important when third-party instruments are used as reference.
Antenna at base	Selectable list	The antenna used at the base. If the real-time data format contains information of the antenna, certain corrections based on this information are applied in order to provide correct results. The real-time data formats Leica , Leica 4G , CMR/CMR+ and RTCM v3 contain this information.  If the reference data is corrected by absolute antenna calibration values and a Leica standard antenna is being used on the rover, select ADVNULLANTENNA as base antenna.
RTK base is sending unique ID	Check box	If checked, an ID can be typed in.
RTK base ID	Editable field	The special ID of the base station from which real-time data is received. The allowed minimum and maximum values vary.
	From 0 to 31	For RTK data format: Leica and RTK data format: CMR/CMR+ .
	From 0 to 1023	For RTCM version: 2.x .
	From 0 to 4095	For RTK data format: Leica 4G and RTK data format: RTCM v3 .

Next step

Page changes to the **RTK network** page.

RTK Rover Settings, RTK network page

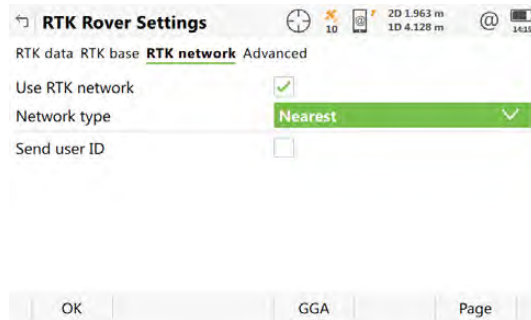

Key	Description
OK	To accept changes and return to the panel from where this panel was accessed.
Fn GGA	To activate the sending of a GGA message for RTK networks. Refer to "18.7.3 Configuration of GGA Message Sending for Reference Network Applications".
Page	To change to another page on this panel.

Description of fields

Field	Option	Description
Use RTK network	Check box	If checked, an RTK network can be used.
Network type	Nearest	Defines the type of reference network to be used. Refer to SmartNet documentation for more detailed descriptions. The rover sends its position using NMEA GGA message to SmartNet. From this position, SmartNet determines the reference in a reference network that is closest to the rover. The corrections from that reference are sent to the rover. Supported for all real-time data formats. If this option is selected, an NMEA GGA message must be activated using Fn GGA .
	i-MAX	individualised Master-AuXiliary corrections. The rover sends its position using NMEA GGA message to SmartNet where the Master-Auxiliary corrections are calculated. SmartNet individualises the corrections, which means it determines the best suitable corrections for that rover. If this option is selected, an NMEA GGA message can be activated using Fn GGA .

Field	Option	Description
	MAX	Master-AuXiliary corrections The rover typically does not send its position to SmartNet. SmartNet calculates and sends Master-Auxiliary corrections to the rover. The rover individualises the corrections for its position, which means it determines the best suitable corrections. The corrections are sent in RTCM v3 with message types 1015/1016. If this option is selected, an NMEA GGA message can be activated using Fn GGA .
	VRS	Virtual Reference Station . If this option is selected, an NMEA GGA message must be activated using Fn GGA . Refer to "18.7.3 Configuration of GGA Message Sending for Reference Network Applications".
	FKP	Area correction parameters. Derived from German: FlächenKorrektur Parameter
Send user ID	Check box	Activates the sending of a Leica proprietary NMEA message defining the user.
User ID 1 and User ID 2	Editable field	The specific user IDs to be sent as part of the Leica proprietary NMEA message. By default the serial number of the instrument is displayed.

Next step

Page changes to the **Advanced** page.

RTK Rover Settings, Advanced page

Description of fields

Field	Option	Description
Compute xRTK positions	Check box	To activate or deactivate a slightly less accurate RTK position type, typically 5 - 10 cm, automatically providing more availability for phase fixed positions with a reliability of 99%. Recommended when working in heavy canopy environments.  For NMEA messages, positions measured with the xRTK mode are flagged as fixed.
SBAS tracking		Allows the Space-Based Augmentation System to be configured to provide extra corrections in conjunction with GPS signals. Also commonly referred to as Satellite-Based Augmentation System , SBAS provides corrected time and distance measurements calculated by a network of ground relay stations and geostatic satellites. An SBAS can correct for problems such as atmospheric delays, poor satellite geometry and incorrect satellite positioning.

Field	Option	Description
	Automatic SBAS	SBAS satellites are tracked and the SBAS service used is automatically selected.
	WAAS	Wide Area Augmentation System satellites are tracked.
	EGNOS	European Geostationary Navigation Overlay System satellites are tracked.
	MSAS	MTSAT Satellite-based Augmentation System where MTSAT stands for Multi-functional Transport SATellite
	GAGAN	GPS Aided Geo Augmentation Navigation satellites are tracked.

Next step

Page changes to another page on this panel.

18.7.2

Configuration with Digital Cellular Phone and Radio

Description

An ideal real-time setup is to combine a radio and a digital cellular phone to get the best of both technologies. The radio can be used where the radio signals can be received. The advantage is that the radio data transmission is free. If the radio channel is broken, when the rover goes out of range or due to an obstruction, change to the digital cellular phone to complete the measurements. This switch allows maximum productivity and minimal costs with real-time applications.

Field procedure step-by-step

1. Set up a base.
2. On the base, attach a digital cellular phone to one port and a radio to another port.
3. Configure both connections on the base.
4. Start the base. Real-time data is transmitted on two ports simultaneously - using different devices.
5. Set up a rover.
6. On the rover, attach a digital cellular phone to one port and a radio to another port.
7. Use two working styles to configure both connections on the rover.
8. Start the rover using either the digital cellular phone connection or the radio connection.
9. On the rover, change the working style in use in order to change between using digital cellular phone and radio. There is no need to return to the base.

18.7.3

Configuration of GGA Message Sending for Reference Network Applications

Description

Most reference networks require an approximate position of the rover. For reference network applications, a rover dials into the reference network and submits its approximate position in form of an NMEA GGA message.

By default, the instrument sends GGA messages with updated current positions automatically when a reference network is selected.

Surveying regulations in some countries require that one certain position can be selected. This position is then sent to the reference network as GGA message through the real-time connection every five seconds.

Refer to "E.3 GGA - Global Positioning System Fix Data" for information on GGA message format.

Access

In **RTK Rover Settings, RTK network** page, press **Fn GGA**.

Send GGA NMEA

Key	Description
OK	To accept changes and return to the panel from where this panel was accessed.
Last	Available for GGA position to send: Last or current position . To use the same coordinates in the GGA message as when the instrument was last used in a reference network application. This functionality is possible when position coordinates from a previous reference network application are still stored in the internal memory.
Here	Available for GGA position to send: Last or current position . To use the coordinates of the current navigation position in the GGA message.
Fn Coord	Available for GGA position to send: From job . To view other coordinate types. Local coordinates are available when a local coordinate system is active.
Fn Ell Ht and Fn Height	To change between the ellipsoidal and the orthometric height. Available for local coordinates.

Description of fields

Field	Option	Description
GGA position to send	Automatic	The current rover position is sent to the reference network. The position is updated and sent every 5 seconds.
	From job	A point from the job can be selected in Point ID . The position of this point is sent to the reference network every 5 seconds.

Field	Option	Description
	Last or current position	The position last used in a reference network application or the current navigation position can be selected using Last or Here . The selected position is sent every 5 seconds.
	None	No GGA message is sent to the reference network.
Point ID	Selectable list	Available for GGA position to send: From job . The coordinates of this point are sent out in the GGA message.

18.8

Base RTK 1 / Base RTK 2



Unavailable for GS08plus.

Description

The real-time connection allows real-time related parameters to be configured. These parameters include defining the real-time messages, data rates and time slicing. Up to two real-time connections can be configured on the instrument.

Access

For RTK base:

- In **Base Connection Settings** highlight **Base RTK 1. Edit**.



Two real-time devices can be attached to two different ports, for example a radio and a digital cellular phone. On the reference, the two devices can operate simultaneously. Highlight **Base RTK 2** and press **Edit** to configure a second real-time connection.

RTK Base Settings (RTK 1)/ RTK Base Settings (RTK 2), General page

The available fields and pages on this page depend on the selected settings.

Key	Description
OK	To accept changes and return to the panel from where this panel was accessed.
Device	Available for Connect using: GS Port 1/GS Port 2/GS Port 3/GS Port 4/GS radio/GS modem . To create, select, edit or delete a device. Refer to "20.2 Accessing Devices".
Page	To change to another page on this panel.

Description of fields

Field	Option	Description
Transmit RTK data	Check box	Activates the base real-time connection.
Connect using	GS Port 1	For GS10: The physical port P1 on the box. For GS14/GS15/GS16/GS18: The red LEMO port. For GS25: The physical LEMO port P1 on the box.
	GS Port 2	For GS10: The physical port P2 on the box. For GS15: The black LEMO port. For GS25: The physical LEMO port P2 on the box.
	GS Port 3	For GS10: The physical port P3 on the box. For GS15/GS25: The slot for a device.
	GS Port 4	For GS25: The physical LEMO port P4 on the box.
	GS Internet 1, GS Internet 2 and GS Internet 3	The Internet ports on the GS. If these ports are not assigned to a specific connection, then these ports are extra remote ports.
	GS radio GS modem	Available for GS14/GS16/GS18. Available for GS14/GS16.
Device	Display only	The device currently assigned to the selected port within the active working style.
RTK data format	Leica, Leica 4G, CMR/CMR+, RTCM v3, RTCM 18,19 v2, RTCM 1,2 v2, RTCM 9,2 v2, RTCM 20,21 v2, RTCM 1,2,18,19 v2	Refer to "18.7.1 Configuration of a Rover Real-Time Connection" for information about these real-time data formats.
	RTCM v3 (MSM)	Refer to "18.7.1 Configuration of a Rover Real-Time Connection" for information about this real-time data format. RTCM v3 (MSM) generates GNSS receiver observables in a universal manner to meet the coming reality when more GNSS and their signals become available. Encodes the raw observations of all tracked GNSS signals and delivers them as RTK corrections. RTCM v3 (MSM) and RTCM v3 are treated separately.

Field	Option	Description
RTCM version	1.x, 2.1, 2.2 or 2.3	Available when the selected RTK data format is an RTCM version 2 format. The same version must be used at the reference and the rover.
Use external antenna on GS15	Check box	Available for Connect using: GS Port 3 . Allows external radio/GSM antenna on the GS15 to be used for slot devices.

Next step

Page changes to the **Data rates** page.

RTK Base Settings (RTK 1)/
RTK Base Settings (RTK 2),
Data rates page

Description

For all real-time data formats, parts of the message can be output at different rates.

The settings on this panel define the output rates for the various parts of the selected real-time data format. The available fields on this panel depend on the selected setting for **RTK data format** in **RTK Base Settings (RTK 1)/RTK Base Settings (RTK 2)**.

Description of fields

Field	Option	Description
RTK data format	Display only	The selected data format.
Data	From 0.1s to 60.0s	Rates for the transmission of raw observations. The default settings are suitable for standard applications. They can be changed for special applications. A check is performed for permissible combinations.
Message type	Compact Extended	The message type of RTCM v3 and Leica 4G . Suitable for standard applications. For RTK data format: RTCM v3 (MSM) , encoding according to MSM3. Refer to "RTK Rover Settings, General page". For RTK data format: RTCM v3 (MSM) , encoding according to MSM5. Refer to "RTK Rover Settings, General page".
Coordinates	From 10s to 120s	Rate for the transmission of reference coordinates.
Information	From 10s to 120s Off	Rate for the transmission of base station information such as point ID. Available for RTCM v3 (MSM) . No receiver and antenna descriptors information message is sent out. Default for Message type: Compact .
End of message	Nothing or CR	To add a Carriage Return at the end of the real-time message.

Field	Option	Description
Messages to be streamed (local coordinates will be computed using the coordinate system on the GS sensor)	Selectable list	Available for RTCM version: 2.3 . The messages sent within the coordinate message.
RTK base ID	Editable field	<p>An identification for a base station. It is converted into a compact format and sent out with real-time data in all real-time data formats. It is different from the point ID of the base station.</p> <p>If working with several base stations in time slicing mode on the same frequency, an ID of the base station is required. In this case, the ID of the base station from which data is accepted must be typed in at the rover.</p> <p>The allowed minimum and maximum values vary.</p> <p>From 0 to 31 For Leica and CMR/CMR+.</p> <p>From 0 to 1023 For any RTCM version 2 format.</p> <p>From 0 to 4095 For Leica 4G, RTCM v3 and RTCM v3 (MSM).</p>

Next step

Page changes to the **Time slicing** page.

RTK Base Settings (RTK 1)/
RTK Base Settings (RTK 2),
Time slicing page

Description of fields

Field	Option	Description
Use time slicing	Check box	The possibility to send delayed real-time messages. This functionality is required when real-time messages from different base stations are sent on the same radio channel. Time slicing works for all device types.
Total base stations being used	2, 3 or 4	The number of base stations in use from where real-time messages are sent.

Field	Option	Description
Time slot for this base	2, 3 or 4 The contents of the select-able list depend on the settings for Total base stations being used .	The time slot represents the current time delay. The number of possible time slots is the number of base stations in use. The time delay equals 1s divided by the total number of base stations. If two base stations are used, the time delay is 0.50s. Therefore, the time slots are at 0.00s and at 0.50s. With three base stations, the time delay is 0.33s. The time slots are at 0.00s, 0.33s and 0.66s.

Next step

Page changes to another page on this panel.

18.9

NMEA 1 / NMEA 2



Unavailable for GS08plus.



For GS08plus, streaming of GGA messages is supported for RTK network operations.

Description

National **M**arine **E**lectronics **A**ssociation has developed a message standard related to the marine electronics industry. NMEA messages have been accepted as the standard for sharing specific data information between companies since the late 1970s. Refer to "E NMEA Message Formats" for a comprehensive description of each NMEA message.

The settings on this panel define the port, the device and the type of NMEA message to be used for the NMEA Out connection.

Up to two NMEA Out connections can be configured. Each NMEA Out connection can output different messages at different rates with different talker IDs. The output of NMEA messages on both ports is simultaneous.

The panels for the settings of both NMEA connections are identical except for the title - **NMEA Output 1** and **NMEA Output 2**. For simplicity, the title **NMEA Output 1** is used in the following.

Access

For RTK rover:

- In **Connection Settings, GS connections** page, highlight **NMEA 1** or **NMEA 2**. **Edit**.

For CS35:

- Unavailable. Use Windows to configure a connection.

NMEA Output 1

Key	Description
OK	To accept changes and return to the panel from where this panel was accessed.
Messages	To configure what NMEA messages are output, the rates and the output timing method. Refer to paragraph "NMEA Messages".
Device	To create, select, edit or delete a device.

Description of fields

Field	Option	Description
Stream NMEA messages from the GS sensor	Check box	Activates the output of NMEA.
Connect using	GS Port 1	For GS10/GS25: The physical port P1 on the box. For GS14/GS15/GS16/GS18: The red LEMO port.
	GS Port 2	For GS10/GS25: The physical port P2 on the box. For GS15: The black LEMO port.
	GS Port 3	For GS10: The physical port P3 on the box. For GS15/GS25: The slot for a device.
	GS Port 4	For GS25: The physical port P4 on the box.
	GS BT	The Bluetooth port on the GS.
	GS Internet 1, GS Internet 2, GS Internet 3	The Internet ports on the GS. If these ports are not assigned to a specific connection, then these ports are extra remote ports.
	GS radio	Available for GS14/GS16.
	GS modem	Available for GS14/GS16/GS18.
Device	Display only	Usually, RS232 is used to transfer NMEA messages.
NMEA Version	4.0 (extended)	Backwards compatible to NMEA in Leica Captivate version 5.0 plus BeiDou support.

Field	Option	Description
	4.1 (compact)	More compact message output than in Leica Captivate version 5.0 plus BeiDou support.
Use a defined talker ID	Check box	When this box is checked, a user-defined talker ID can be typed in. Otherwise, the standard NMEA Talker ID is used: GN = G lobal N avigation S atellite S ystem = GPS with GLONASS/Galileo/BeiDou in any combination GP = GPS only GL = GLONASS GA = Galileo BD = BeiDou
Talker ID	Editable field	Available when Use a defined talker ID is checked. Appears at the beginning of each NMEA message.
Messages to be streamed (local coordinates will be computed using the coordinate system on the GS sensor)	Display only	The NMEA messages currently selected for output.

Overview of NMEA messages sent depending on settings

Message	GPS	GNSS	GPS	GNSS
	NMEA v4.0		NMEA v4.1	
GGA	\$GPGGA	\$GNGGA	\$GPGGA	\$GNGGA
GGK	\$GPGGK	\$GNGGK	\$GPGGK	\$GNGGK
GGK_PT	\$PTNL,GGK	\$PTNL,GGK	\$PTNL,GGK	\$PTNL,GGK
GGQ	\$GPGGQ	\$GNGGQ \$GPGGQ \$GLGGQ \$GAGGQ \$BDGGQ	\$GPGGQ	\$GNGGQ
GLL	\$GPGLL	\$GNGLL	\$GPGLL	\$GNGLL
GNS	\$GPGNS	\$GNGNS	\$GPGNS	\$GNGNS
GSA	\$GNGSA	\$GPGSA	\$GPGSA	\$GNGSA
GSV	\$GPGSV	\$GPGSV \$GLGSV \$GAGSV \$BDGSV	\$GPGSV	\$GPGSV \$GLGSV \$GAGSV \$BDGSV

Message	GPS	GNSS	GPS	GNSS
	NMEA v4.0		NMEA v4.1	
LLK	\$GPKLL	\$GNLLK \$GPKLL \$GLLLK \$GALLK \$BDLLK	\$GPKLL	\$GNLLK
LLQ	\$GPKLQ	\$GNLLQ \$GPKLQ \$GLLLQ \$GALLQ \$BDLLQ	\$GPKLQ	\$GNLLQ
RMC	\$GNRMC	\$GNRMC	\$GNRMC	\$GNRMC
VTG	\$GPVTG	\$GNVTG	\$GPVTG	\$GNVTG
ZDA	\$GPZDA	\$GPZDA	\$GPZDA	\$GPZDA

NMEA Messages

This panel shows the messages that can be output, which messages are currently output, the output rates and the output timing method.

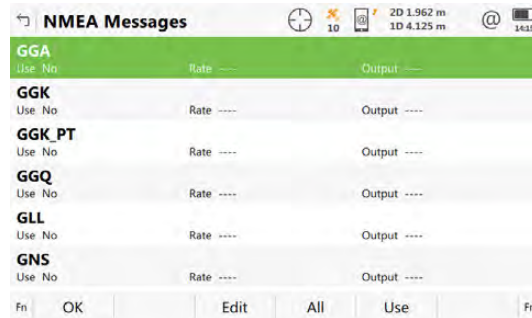

Key	Description
OK	To accept changes and return to the panel from where this panel was accessed.
Edit	To configure how the currently highlighted message is output. Refer to paragraph "NMEA Message to Send".
All and None	To activate and deactivate the output for all messages.
Use	To activate and deactivate the output for the highlighted message.

Next step

IF an NMEA message	THEN
is not to be configured	OK closes the panel.
is to be configured	highlight the message and Edit .

NMEA Message to Send

Key	Description
OK	To accept changes and return to the panel from where this panel was accessed.

Description of fields

Field	Option	Description
Stream the NMEA message	Check box	When this box is checked, the selected NMEA message is output.
Send message	Immediately	The NMEA message is created as soon as the information is available. It is sent out in the time interval as defined in Rate .
	On point stored	The NMEA message is sent on point storage.  If the time interval defined in Rate is shorter than the epochs of the panel update, then the internal computation of positions is changed to allow the specified rate of NMEA positions. The panel update remains unchanged.
Point type		Available for Send message:On point stored . Defines the type of points for which the NMEA message is sent.
	All points	The NMEA message is sent when any type of point is stored.
	Occupied pts only	The NMEA message is sent when a manually measured point is stored.
	Auto pts only	The NMEA message is sent when auto points are stored.
Rate	From 0.05s to 3600.0s	Available unless Send message: On point stored . Defines the time intervals at which the NMEA messages are created.
Don't send message if quality limit is exceeded	Check box	When this box is checked the CQ control can be defined.

Field	Option	Description
Check quality of	Position only, Height only or Position & height	Available when Don't send message if quality limit is exceeded is checked. Activates a control over the coordinate quality. If the coordinate quality of the position and/or height component exceeds the limit as defined in Quality limit , then NMEA messages are not output.
Quality limit	Editable field	Available when Don't send message if quality limit is exceeded is checked. The limit for the coordinate quality up to which NMEA messages are output.

Next step

1. **OK** returns to **NMEA Messages**.
2. **OK** returns to the panel from where **NMEA Messages** was accessed.

18.10

Remote (OWI)



Unavailable for GS08plus.

Description

The remote connection allows:

- the instrument to be controlled using a device other than the field controller, for example a computer. **Outside World Interface** or **Leica Binary 2** commands can be used to control the instrument through the remote port. Documentation for OWI and LB2 is available on request from the Leica Geosystems representative.
- a message log to be requested from a remote client via an OWI message. A message log contains a history of warning messages and message lines.
- the downloading of data directly from the instrument's memory device to Infinity through a serial port on the computer. The CS does not need to be removed from the instrument.

The settings on this panel define the port and the device to be used for the remote control.



A port configured as a remote port can be used to output event input, meteo or tilt notification messages.



The OWI commands listed here are protected by a licence key. Refer to "29.3 Load licence keys" for information on licence keys. The corresponding LB2 commands are also protected. If these OWI commands have been activated by a licence key, it is indicated in **About Leica Captivate**.

- | | | | | |
|-------|-----------|-------|-------|-------|
| • AHT | • DPM | • GLL | • POB | • RTK |
| • ANT | • GGA | • GNS | • POE | • TPV |
| • CNF | • GGK | • LLK | • POQ | • USR |
| • DCF | • GGK(PT) | • LLQ | • POS | |
| • DCT | • GGQ | • NET | • RMC | |

Access

For RTK rover:

- In **Connection Settings, GS connections** page, highlight **Remote (OWI). Edit**.

For CS35:

- Unavailable. Use Windows to configure a connection.

Remote OWI Connections



Key	Description
OK	To accept changes and return to the panel from where this panel was accessed.
Control	To configure more parameters.
Device	Available unless an Internet connection is used. To create, select, edit or delete a device. Refer to "20.2 Accessing Devices".

Description of metadata

Metadata	Description
Connection	The connection configured for the ports. Any port which is not configured is automatically assigned the remote connection.
Device	The hardware connected to the chosen port.

18.11

PPS output



The PPS output is an optional interface requiring a special port.

Description

PPS stands for **P**ulse **P**er **S**econd. It is a pulse that is output at a specified interval time. The pulse can be used to activate another device. Additionally, a notification message can be output through the GS25 ports P1, P2, P3, P4 or BT when a PPS output occurs.

For example, in aerial photography, an aerial camera can be configured to take a photo each time it receives a pulse from the instrument.

The settings on this panel define the output port and parameters for the PPS option. This panel is available if the instrument is fitted with a PPS output port.



This option is only available on GS25.

Access

For RTK rover:

- In **Connection Settings, GS connections** page, highlight **PPS output. Edit.**

PPS Output, PPS Output page

PPS Output Notification

Output a Pulse Per Second from the GS

Rate **1.0 sec**

Polarity **Positive edge**

OK Page

Key	Description
OK	To accept changes and return to the panel from where this panel was accessed.
Page	To change to another page on this panel.

Description of fields

Field	Option	Description
Output a Pulse Per Second from the GS	Check box	When this box is checked, the output of PPS is activated and relevant settings can be configured.
Rate	From 1.0 sec to 20.0 sec	The rate at which pulses are output.
Polarity	Negative edge and Positive edge	Measure the time from the negative edge or the positive edge of the pulse.

Next step

Page changes to the **Notification** page.

PPS Output, Notification page

Key	Description
OK	To accept changes and return to the panel from where this panel was accessed.
Page	To change to another page on this panel.

Description of fields

Field	Option	Description
Send notification on each PPS output	Check box	When this box is checked, the output of a notification message with each PPS output is activated. Refer to "H PPS Output Notify Message Format" for information on the message format.

Field	Option	Description
Connecting	GS Port 1, GS Port 2, GS Port 3 or GS Port 4	The ports on the GS25 used for the connection.
	GS BT	The Bluetooth ports on the GS25 used for the connection.
Device	Display only	The hardware connected to the chosen port.
Notification	Selectable list	The message can be in ASCII or in binary format.

Next step

Page changes to another page on this panel.

18.12

Event input 1/ Event input 2



The event input is an optional interface requiring a special port.

Description

The event input interface allows pulses which are sent from devices connected to the instrument to be recorded. These records can later be superimposed on the processed kinematic data and the positions where the events took place can be interpolated in Infinity. Events logged during real-time operations can also be exported to an ASCII file using an appropriate format file. Additionally, a notification message can be output through the GS25 ports P1, P2, P3, P4 or BT providing information about when the event occurred. A port configured as a remote port can be used to output the notification message.

For example, in aerial photography, an aerial camera can be connected through the event input port. When the shutter opens, the position at which the event occurred is recorded.

The settings on this panel define the input port and parameters for the event input option. This panel is available if the instrument is fitted with an event input port.



This option is only available on GS25.

Event Input 1/ Event Input 2, Event input page

Key	Description
OK	To accept changes and return to the panel from where this panel was accessed.
Page	To change to another page on this panel.

Description of fields

Field	Option	Description
Receive event input pulses	Check box	When this box is checked, the detection and logging of events being sent to the event ports is activated and relevant settings can be configured.
Information to log	Time,pos,vel ,CQ, Time,pos,vel , Time,pos or Time	Time, position, velocity and coordinate quality can be recorded in various combinations.
Polarity	Negative edge or Positive edge	The polarity according to the device in use.
Accuracy limit	Editable field	If two or more events take place during the time defined in s, the first event is recorded. Enter 0 to accept all events. The shortest recording time is 0.05 s.
Description	Editable field	Records up to four lines of data with the event record. Use the description to differentiate between the two event records if two event input ports are used at the same time.

Next step

Page changes to the **Bias values** page.

Event Input 1/
Event Input 2,
Bias values page

Key	Description
OK	To accept changes and return to the panel from where this panel was accessed.
Page	To change to another page on this panel.

Description of fields

Field	Option	Description
External bias	Editable field	Sets a calibration value in ns according to the external event device and cable being used.
Enter user defined internal bias	Check box	When this box is checked, personal calibration values for the particular instrument can be configured. When this box is not checked, default calibration values for the particular instrument are used.

Field	Option	Description
Internal bias	Editable field	Available when Enter user defined internal bias is checked. Sets the particular calibration value in ns for the instrument.

Next step

Page changes to the **Notification** page.

Event Input 1/
Event Input 2,
Notification page

Key	Description
OK	To accept changes and return to the panel from where this panel was accessed.
Page	To change to another page on this panel.

Description of fields

Field	Option	Description
Send notification on each Event Input	Check box	When this box is checked, the output of a notification message with each event input is activated. Refer to "G Event Input Notify Message Format" for information on the message format.
Connect using	GS Port 1, GS Port 2, GS Port 3 or GS Port 3 GS BT	The ports on the GS25 which are used for the connection. The Bluetooth ports on the GS25 used for the connection.
Device	Display only	The hardware connected to the chosen port.
Notification	Selectable list	The message can be in ASCII or in binary format.

Next step

Page changes to another page on this panel.

18.13

Total station

Description

The settings on this panel define the communication of the field controller with Leica TS and third-party instruments.



For CS35, the settings for **Model** and **Connect using** can be selected. The connection itself must be configured in Windows.

Access

For a connection from CS to Total station:

- In **Connection Settings** highlight **Total station. Edit.**

Connect to Total Station

Key	Description
OK	To accept changes and return to the panel from where this panel was accessed.
Search	To search for all available Bluetooth devices. If more than one Bluetooth device is found a list of available devices is provided. Available if Connect using:Bluetooth is selected.
Control	Available for certain devices connected to certain connections. To configure more parameters, for example changing the radio channel.
Default	To return the fields back to their default values.

Description of fields

Field	Option	Description
Manufacturer	Selectable list	The brand of the instrument.
Model	Selectable list	The instrument model.
Connect using	Cable, Bluetooth, Long-range TS, External radio	How the instrument is connected. The options available depend on the selection for Model . The availability of the other fields depends on the selection made here.  For CS35, use Windows to configure the connection itself.
	CTR20 expansion pack	To configure a connection between a CS20 with robotic module and a TS with RH17.
Baud rate	From 1200 to 115200	Frequency of data transfer from instrument to device in bits per second.
Parity	None, Even or Odd	Error checksum at the end of a block of digital data.
Data bits	6, 7 or 8	Number of bits in a block of digital data.
Stop bit	1 or 2	Number of bits at the end of a block of digital data.
Flow control	None or RTS/CTS	Activates hardware handshake. When the instrument/device is ready for data, it asserts the Ready To Send line indicating it is ready to receive data. This line is read by the sender at the Clear To Send input, indicating it is clear to send the data.

Field	Option	Description
Name and Bluetooth ID	Display only	The last connected total station using Bluetooth or CTR20 expansion pack. If no information of a last total station is available, then ---- is displayed.

18.14

GSI output

Description

Each time a measured point is stored to the job, GSI data is streamed through the configured port of the field controller.

Access

In **Connection Settings** highlight **GSI output**. **Edit**.



Unavailable for CS35. Use Windows to configure a connection.

GSI Output Connection

Key	Description
OK	To accept changes and return to the panel from where this panel was accessed.
Search	Available when CS Bluetooth 1 or CS Bluetooth 2 are selected. To search for all available Bluetooth devices. If more than one Bluetooth device is found a list of available devices is provided.
Device	To create, select, edit or delete a device.

Description of fields

Field	Option	Description
Output GSI data to device	Check box	Activates the connection.
Connect using	CS RS232 port	The RS232 port on the field controller.
	CS Bluetooth 1 and CS Bluetooth 2	The Bluetooth ports on the field controller which are used.
	TS Bluetooth 1 and TS Bluetooth 2	The Bluetooth ports on the TS16 which can be used.
	Cable	The RS232 port on the TS16.

Field	Option	Description
	Radio handle	Hotshoe connection for RadioHandle. This port is on top of Communication side cover.
Device	Display only	The device currently assigned to the selected port.
GSI Format	GSI8 polar & cartesian	GSI Polar and Cartesian (8 data characters) (Point ID, Hz, V, SlopeDist, PPM, E, N, Elev.)
	GSI16 polar	GSI Polar (16 data characters) (Point ID, Hz, V, SlopeDist, PPM, reflector height)
	GSI16 cartesian	GSI Cartesian (16 data characters)(E, N, Elev, Reflector Height)
	Pt, N, E, Ht, date	Coordinate data(Northing BEFORE Easting)
	Pt, E, N, Ht, date	Coordinate data (Easting BEFORE Northing)
	Pseudo NMEA GGA	Based on NMEA (N ational M arine E lec- A ssociation), which is a standard for interfacing marine electronic devices.
	GSI8 polar	GSI Polar (8 data characters) (Point ID, Hz, V, SlopeDist, PPM)
	GSI16 polar 2	GSI Polar (16 data characters) (Point ID, Hz, V, SlopeDist, PPM)

Output format - GSI Format

GSI data is transmitted in blocks. Every block consists of several data words, refer to the examples in the following table. Every data word begins with a two character Word Index, the WI code, specifying the data type within this block. Each GSI8 word has in total 16 characters, consisting of 7 information characters followed by 8 data characters and finally the blank character ASCII code 32. The GSI16 block is like the GSI8 block, but begins with * and the data word contains 16 characters for large values such as UTM coordinates, alphanumeric codes, attributes or point IDs.

Example 1 shows a GSI8 block sequence with the words for point ID (11), Easting coordinate (81) and Northing coordinate (82). Example 2 shows a GSI16 block sequence with the words for point ID (11), horizontal (21) and vertical angle (22).

Type	GSI8 Polar&Cart	GSI16 Polar	GSI16 Cartesian
WI 11	Point ID	Point ID	Point ID
WI 21	Hz	Hz	-
WI 22	V	V	-
WI 31	SlopeDist	SlopeDist	-
WI 51	PPM Total/mm	PPM Total/mm	-
WI 81	East	-	East

Type	GSI8 Polar&Cart	GSI16 Polar	GSI16 Cartesian
WI 82	North	-	North
WI 83	Elev.	-	Elev.
WI 87	Refl. Ht	-	Refl. Ht

Example 1: GSI8

Each word has 16 characters of which 8 characters are used for the data block.

Word 1	Word 2	Word 3
110001+0000A110	81..00+00005387	82..00-00000992
110002+0000A111	81..00+00007586	82..00-00003031
110003+0000A112	81..00+00007536	82..00-00003080
110004+0000A113	81..00+00003839	82..00-00003080
110005+0000A114	81..00+00001241	82..00-00001344

Example 2: GSI16

Each word has 24 characters of which 16 characters are used for the data block.

Word 1	Word 2	Word 3
*110001+000000000PNC0055	21.002+0000000013384650	22.002+0000000005371500
*110002+000000000PNC0056	21.002+0000000012802530	22.002+0000000005255000
*110003+000000000PNC0057	21.002+0000000011222360	22.002+0000000005433800
*110004+000000000PNC0058	21.002+0000000010573550	22.002+0000000005817600
*110005+000000000PNC0059	21.002+0000000009983610	22.002+0000000005171400

GSI Word information

Pos.	Name	Description of values	Applicable for
1-2	Word Index (WI)		
3	No significance	:: No information.	WI11, WI21, WI22, WI31, WI51, WI81, WI82, WI83, WI87
4	Automatic index information	:: No information. 0: Tilt compensator:Off 3: Tilt compensator:On	WI21, WI22
5	Input mode	:: No information. 0: Measured values transferred from instrument 1: Manual input from keyboard 2: Measured value, Hz correction:On. 3: Measured value, Hz correction:Off. 4: Result calculated from functions	WI21, WI22, WI31, WI51, WI81, WI82, WI83, WI87

Pos.	Name	Description of values	Applicable for
6	Units	.: No information. 0: Distance:Metre (m) , last digit 1 / 1000 m 1: Distance:US ft (ft) last digit 1 / 1000 ft 2: Angle:400 gon 3: Angle:360° dec 4: Angle:360°" 5: Angle:6400 mil 6: Distance:Metre (m) , last digit 1 / 10000 m 7: Distance:US ft (ft) last digit 1 / 10000 ft	WI21, WI22, WI31, WI81, WI82, WI83, WI87
7	Sign	+: Positive value -: Negative value	WI21, WI22, WI31, WI51, WI81, WI82, WI83, WI87
8-15 8-23	Data	Data includes a sequence of 8 (16) numerical or alphanumerical characters.  Certain data blocks are allowed to carry more than one value for exam- ple ppm/mm. This data is automatically transferred with the according sign before each single value.	WI11, WI21, WI22, WI31, WI51, WI81, WI82, WI83, WI87
1624	Separating character	: Blank	WI11, WI21, WI22, WI31, WI51, WI81, WI82, WI83, WI87

Output format - Pt, N, E, Ht, date

Format

Point ID, Northing, Easting, Elevation, Date, Time <CR/LF>

Description of fields

The format settings are defined in **Regional**.

Field	Description
Point ID	Text describing the point identification
Northing	The Northing coordinate.
Easting	The Easting coordinate.
Elevation	The height coordinate.
Date	The measurement/origination date.
Time	The measurement/origination time.

Field	Description
<CR/LF>	Carriage Return Line Feed

Example

2004,4997.635,6010.784,393.173,09/10/2001,16:34:12.2

2005,4997.647,6010.765,393.167,09/10/2001,16:34:12.4

2006,4997.657,6010.755,393.165,09/10/2001,16:34:12.7

Output format - Pt, E, N, Ht, date

Format

This output format is identical to the Pt,N,E,Ht,Date format except the order of the Easting and Northing variables are reversed.

Output format - Pseudo NMEA GGA

Description

This output format is based on NMEA (National Marine Electronics Association), which is a standard for interfacing marine electronic devices.

Format

\$GPGGA,Time,Northing,N,Easting,E,1,05,1.0,Elevation,M,0.0,M,0.0,0001*99
<CR/LF>

Description of Fields

Field	Description
\$GPGGA	Sentence identification (header including talker identification). A Talker ID appears at the beginning of the header of each NMEA message.
Time	UTC time of position (hhmmss.ss)
Northing	The Northing coordinate (always output with 2 decimal places)
N	Fixed text (N)
Easting	The Easting coordinate (always output with 2 decimal places)
E	Fixed text (E)
GPS Quality Indicator	Fixed number (1=no real-time position, navigation fix)
Number of satellites	Number of satellites in use (00 to 12)
HDOP	Fixed number (1.0)
Elevation	The height coordinate (always output with 2 decimal places)
Elevation units	Elevation units (F or M). The format settings are defined in Regional .
Height Geoid	Fixed number (0.0)
Height units	Fixed text (M)
Time since last DGPS update	Fixed number (0.0)

Field	Description
DGPS Base station ID	Fixed number (0.0001)
Checksum	Fixed number (*99)
<CR/LF>	Carriage Return Line Feed

Example

\$GPGGA,171933.97,7290747.02,N,3645372.06,E,1,05,1.0,1093609.54,F,0.0,M,0.0,0001*99

\$GPGGA,171934.20,7290747.02,N,3645372.06,E,1,05,1.0,1093609.54,F,0.0,M,0.0,0001*99

\$GPGGA,171934.45,7290747.03,N,3645372.06,E,1,05,1.0,1093609.54,F,0.0,M,0.0,0001*99



Fields are always separated by a comma. A comma is never placed before the Checksum field. When information for a field is not available, the position in the data string is empty.

18.15

CS Connection

Description

The Remote connection allows the TS instrument to be steered remotely from a field controller where Leica Captivate is running.

The settings on this panel define the port and the device used for the remote connection.

CS Connection

Key	Description
OK	To accept changes and return to the panel from where this panel was accessed.
Device	Available unless Connect using: Cable is selected on TS60. To create, select, edit or delete a device. Refer to "20.2 Accessing Devices".

Description of fields

Field	Option	Description
Allow CS controller to connect to this instrument	Check box	When this box is checked, the remote connection is activated.
Connect using	Cable Radio handle Bluetooth Cable RS232	For TS16: The RS232 port. For MS60/TS60: The cable USB port. Hotshoe connection for RadioHandle. This port is on top of Communication side cover. The Bluetooth port on the TS16 or CS35 which is used. The RS232 port on the MS60/TS60.
Device	Display only	The device currently assigned to the selected port.

Next step

When the connection is established, most keys are locked. Available are:

- **Measure, Distance** and **Store**.
- **Distance** and **Store** have the same functionality as on the CS or as on the TS16/MS60/TS60 when it is independently controlled.
- **Level** goes to **Level & Compensator**. Check the level bubble, laser plummet intensity, tilt compensator and horizontal correction.

18.16

GeoCOM Connection

Description

The GeoCOM Mode permits communication of the TS with a 3rd party device.

GeoCOM Connection

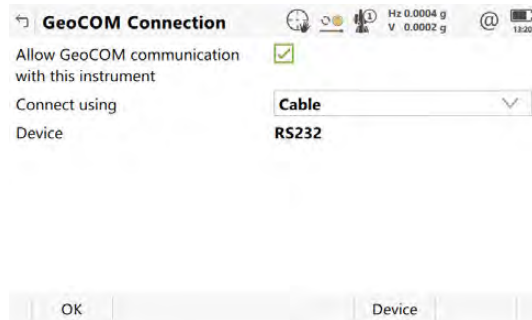

Key	Description
OK	To accept changes and return to the panel from where this panel was accessed.
Search	Available when CS Bluetooth 1 or CS Bluetooth 2 are selected. To search for all available Bluetooth devices. If more than one Bluetooth device is found a list of available devices is provided.

Key	Description
Device	Available unless Connect using: Cable is selected on TS60. To create, select, edit or delete a device. Refer to "20.2 Accessing Devices".

Description of fields

Field	Option	Description
Allow Geo-COM communication with this instrument	Check box	When this box is checked, the GeoCOM mode is activated.
Connect using	Cable	For TS16: The RS232 port. For MS60/TS60: The cable USB port.
	Radio handle	Hotshoe connection for RadioHandle. This port is on top of Communication side cover.
	TS Bluetooth 1 and TS Bluetooth 2	The Bluetooth ports on the TS16 which can be used.
	Cable RS232	The RS232 port on the MS60/TS60.
	WLAN	The WLAN port on the MS60/TS60.
Device	Display only	The device currently assigned to the selected port.

19

Connections - All other connections, Control Key

19.1

Digital Cellular Phones

19.1.1

Overview

Description

For digital cellular phones, information such as

- the base stations that can be contacted
- the phone numbers of the base stations and
- the type of protocol to be used

can be defined.

Changing the base station to be dialed is of interest in two cases.

- Case 1: Two real-time base stations, each equipped with a digital cellular phone, are set up at two locations belonging to different network providers. When leaving the area of one base, the station can be changed and the other base can be called.
- Case 2: Set up as in case 1. Two separate fixes from each base for each point can be obtained, providing redundancy for future least squares adjustment operations.

Technologies

Technology	Description
CDMA	Code Division Multiple Access is a high speed data transmission for effective and flexible use of available resources such as bandwidth. Users of a cellular phone network occupy the same frequency band. The signal is especially coded for each user.
GSM	Global System for Mobile Communications is a more efficient version of CDMA technology that uses smaller time slots but faster data transfer rates. It is the world's most commonly used digital network.

19.1.2

Configuring a GSM Connection

Access

- For RTK rover and TS:
- In **Connection Settings**, highlight a connection which has a digital cellular phone of GSM technology attached. **Control**.
- For RTK base:
- In **Base Connection Settings**, highlight a connection which has a digital cellular phone of GSM technology attached. **Control**.
-

GSM Dial-Up Connection, Dial-up details page

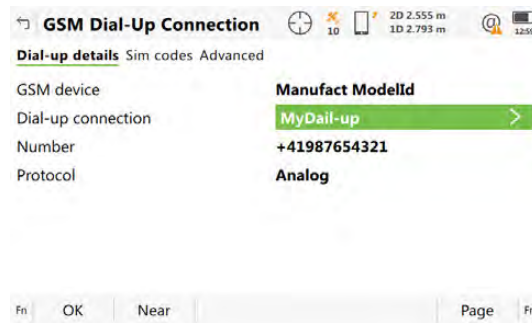

Key	Description
OK	To accept changes and return to the panel from where this panel was accessed.
Near	To find the nearest base station with a digital cellular phone of GSM technology. Available when base stations to dial are already created in Dial-up Connection List . Coordinates of these stations must be known.
Page	To change to another page on this panel.
Fn Command	To send AT commands to the digital cellular phone.

Description of fields

Field	Option	Description
GSM device	Display only	Available for RTK rover and TS. The type of digital cellular phone highlighted when this panel was accessed.
Dial-up connection	Selectable list	Available for RTK rover and TS. The digital cellular phone base station to be dialled. Open the selectable list to access Dial-up Connection List where new base stations can be created and existing base stations can be selected or edited. Refer to "19.6 Configuring the Stations to Dial".
Number	Display only	Available for RTK rover and TS. The number of the digital cellular phone at the selected Dial-up connection as configured in Dial-up Connection List .
Protocol	Display only	Available for RTK rover and TS. The configured protocol of the digital cellular phone at the selected Dial-up connection as configured in Dial-up Connection List .

Next step

Page changes to the **Sim codes** page.

GSM Dial-Up Connection, Sim codes page

Key	Description
OK	To accept changes and return to the panel from where this panel was accessed.

Key	Description
Page	To change to another page on this panel.
Fn Clear	To set the additional editable fields to ----.

Description of fields

Field	Option	Description
Enter active PIN code to edit the setting	Editable field	To enter the Personal Identification Number of the SIM card.
Display PIN code	Check box	When this box is checked, the PIN is displayed in the Enter active PIN code to edit the setting field. When this box is not checked, dots are displayed in the Enter active PIN code to edit the setting field
PUK code	Editable field	If the PIN is locked for any reason, for example the wrong PIN was entered, input the Personal Unblock ing code for access to the PIN.
Display PUK code	Check box	When this box is checked, the PIN is displayed in the Display PUK code field. When this box is not checked, dots are displayed in the Display PUK code field

Next step

Page changes to the **Advanced** page.

GSM Dial-Up Connection,
Advanced page

Description of fields

Field	Option	Description
Network data rate		The network baud rate.
	Selectable list	Network data rate of used digital cellular phone. Default for GSM mode: 9600. Default for UMTS mode: 38400.  For dial-up communications, switch off UMTS and use a network data rate of 9600.
	Autobauding	Select this option for an automatic search of the network baud rate.
Use transparent mode	Check box	Define whether the digital cellular phone uses Radio channel Protocol or not. Check for digital cellular phones that do use transparent mode. Uncheck for digital cellular phones that use RLP. Check with the network provider if the digital cellular phone uses transparent mode or not.

Field	Option	Description
Preferred network type	Automatic	Available for LTE capable phones. Uses any available network type from the GSM to the LTE network.
	Check box	Other options force the LTE phone modem to use only the specified network type. Available for digital cellular phone devices unless they are in data mode. When this box is checked, the currently selected network provider is displayed and the Search key is available. Press Search for a list of all available networks and to select a specific network.

Next step

Page changes to another page on this panel.

19.1.3

Configuring a CDMA Connection

Access

For RTK rover and TS:

- In **Connection Settings**, highlight a connection which has a digital cellular phone of CDMA technology attached. **Control**.

For RTK base:

- In **Base Connection Settings**, highlight a connection which has a digital cellular phone of CDMA technology attached. **Control**.

CDMA Connection

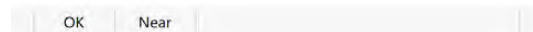
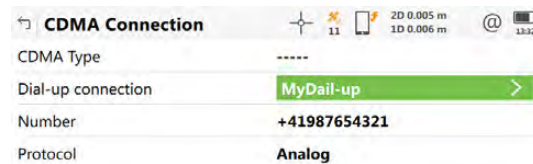

Key	Description
OK	To accept changes and return to the panel from where this panel was accessed.
Near	To find the nearest base station with a digital cellular phone of CDMA technology. Available when base stations to dial are already created in Dial-up Connection List . Coordinates of these stations must be known.
Fn Info	To provide information about the CDMA device being used, such as the manufacturer, the model and the electronic serial number.

Key	Description
Fn Reg	To register the settings of the CDMA digital cellular phone over the air. For US and Canada only. Available when the registration process must be done manually.
Fn Command	To send AT commands to the digital cellular phone.

Description of fields

Field	Option	Description
CDMA Type	Display only	The type of digital cellular phone highlighted when this panel was accessed.
Dial-up connection	Selectable list	The digital cellular phone base station to be dialed. Open the selectable list to access Dial-up Connection List where new base stations can be created and existing base stations can be selected or edited. Refer to "19.6 Configuring the Stations to Dial".
Number	Display only	The number of the digital cellular phone at the selected Dial-up connection as configured in Dial-up Connection List .
Protocol	Display only	The configured protocol of the digital cellular phone at the selected Dial-up connection as configured in Dial-up Connection List .

Next step

Fn Info changes to **CDMA Information**.

CDMA Information

Description of fields

Field	Option	Description
Manufacturer	Display only	The manufacturer of the CDMA device being used.
Model	Display only	The model of the CDMA device being used.
ESN No.	Display only	Electronic Serial Number For registration purposes, send the electronic serial number to the network provider in order to receive the service programming code and the mobile directory number. These numbers must be typed in CDMA Registration .

Next step

1. Press **Print** to print all information to a file CDMA Info.log in the \DATA directory on the data storage device.
2. Press **OK** to return to **CDMA Connection**.
3. For US and Canada only: Press **Reg** to access **CDMA Registration**.

CDMA Registration

The settings allow the CDMA digital cellular phone to be registered over the air.

Description of fields

Field	Option	Description
MSL/SPC	Display only	The S ervice P rogram C ode provided by the network provider.
MDN	Display only	The M obile D irectory N umber provided by the network provider
MSID/MIN	Display only	M obile S tation I dentity Number and M obile I dentification Number. Another 10-digit number to identify the mobile phone. Sometimes identical with the MDN.

Next step

OK to return to **CDMA Connection**.

19.2

Modems

Description

For modems, information such as

- the base stations that can be contacted and
- the phone numbers of the base stations

can be controlled.

Changing the base station to be dialled is of interest in two cases.

Case 1: Two real-time base stations, each equipped with a digital cellular phone, are set up at two locations belonging to different network providers.

When leaving the area of one base, the station can be changed and the other base can be called.

Case 2: Set up as in case 1.

Two separate fixes from each base for each point can be obtained, providing redundancy for future least squares adjustment operations.

Access

For RTK rover and TS:

- In **Connection Settings**, highlight a connection which has a modem attached. **Control**.

For RTK base:

- In **Base Connection Settings**, highlight a connection which has a modem attached. **Control**.

Dial-Up Connection

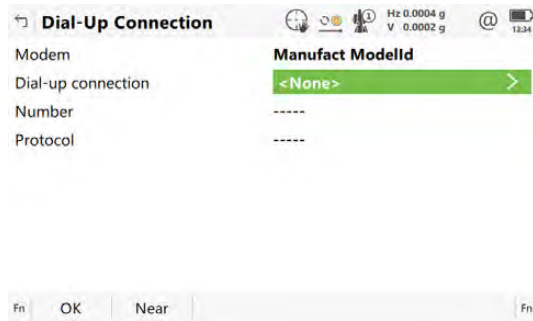

Key	Description
OK	To accept changes and return to the panel from where this panel was accessed.
Near	To find the nearest base station with a modem. Available when base stations to dial are already created in Dial-up Connection List . Coordinates of these stations must be known.
Fn Command	To send AT commands to the modem.

Description of fields

Field	Option	Description
Modem	Display only	The type of modem highlighted when this panel was accessed.
Dial-up connection	Selectable list	The modem base station to be dialled. Open the selectable list to access Dial-up Connection List where new base stations can be created and existing base stations can be selected or edited. Refer to "19.6 Configuring the Stations to Dial".
Number	Display only	The number of the modem at the selected Dial-up connection as configured in Dial-up Connection List .
Protocol	Display only	The configured protocol of the modem at the selected Dial-up connection as configured in Dial-up Connection List .

19.3

Radios for GPS Real-Time

Description

For radios the channels on which the radio broadcasts can be changed. Changing channels changes the frequency at which the radio operates. Not all radios support channel changing.

Changing radio channels is of interest in three cases.

- Case 1: Two real-time base stations are set up at two locations, each broadcasting on a different channel. If the signal from one base station is jammed, the channel can be changed and the other base can be used.

- Case 2: Set up as in case 1.
Two separate fixes for each point can be obtained, providing redundancy for future least squares adjustment operations.
- Case 3: One real-time base and one real-time rover are being used. If the signal is blocked due to radio interference, the channel at the base and the rover can be changed in order to work on a different frequency.

Requirements for channel changing

Type	Requirement
Pacific Crest radio	Contact a Pacific Crest dealer for the activation of channel changing. A special licence might be required.
Satellite radio	Channel switch works with all Satel radios.



Channel changing may contravene radio broadcasting regulations in certain countries. Before operating with radios, check the regulations in force in the working area.



The number of channels available and the frequency spacing between channels depends on the radio used.

For some Satel radios the configuration can be done within Leica Captivate.



If you want to use channel changing, set **RTK base ID** in **RTK Base Settings (RTK 1)/RTK Base Settings (RTK 2), Data rates** page to a different ID for each base site when configuring the base real-time connection. By doing so, the rover can recognise if the incoming real-time data after channel changing is being received from a different base station or if the original base station is using a new frequency. In the first case, the ambiguities are recomputed.

Access

For RTK rover and TS:

- In **Connection Settings**, highlight a connection which has a radio attached. **Control**.

For RTK base:

- In **Base Connection Settings**, highlight a connection which has a radio attached. **Control**.

Radio Channel

Key	Description
OK	To accept changes and return to the panel from where this panel was accessed.
Scan	To provide information such as the station ID, latency and the data format of incoming signals from base stations broadcasting on the same radio channel. This information can be used to select appropriate base stations to dial.
Settings	To edit the channel list of the active radio. In base mode, a password is required for changing the radio settings.

Description of fields

Field	Option	Description
Radio type	Display only	The type of radio highlighted when this panel was accessed.
Channel	Editable field	The radio channel. The channel used must be within minimum and maximum allowed input values. The minimum and maximum allowed input values for a radio depend on the number of channels supported by the radio and the spacing between the channels.
Actual frequency	Display only	Available for all Satel radios. Displays the current frequency of the radio.
Actual Tx power	Display only	Available for some Satel radios. The currently used Tx power of the radio is displayed. The value can vary, if the mode Auto is set in the channel list for the Tx power.
Radio protocol		<p>Available when a Sateline radio is selected as Radio type. Different protocols are selectable. Example: Pacific Crest or TrimTalk compatibility. The radio must be active to accept the settings. The radio need not be connected to a computer and no configuration software is needed.</p> <p>Defines the settings for the used modulation type. Shows the compatibility to Pacific Crest/TrimTalk. The available options depend on the used radio hardware and firmware.</p> <p>Satel 4-FSK, Satel 8-FSK, Satel 16-FSK, PacCrest 4-FSK, PacCrest GMSK, PacCrest FST, TrimTalk(P) GMSK and TrimTalk(T) GMSK</p>
Forward error correction (FEC)	Check box	Available for Radio protocol: Satel 4-FSK . When this box is checked, Forward Error Correction can be set on or off. Satel 4-FSK is the only protocol, where FEC can be defined separately.

Settings depending on protocol

Protocol	Baud rate 12.5 kHz	Baud rate 25 kHz	Modulation	Use Forward Error Cor- rection
Satel 4FSK	9600	19200	4FSK	ON

Protocol	Baud rate 12.5 kHz	Baud rate 25 kHz	Modulation	Use Forward Error Cor- rection
Satel 8FSK	14400	28800	8FSK	OFF
Satel 16FSK	14400	28800	16FSK	ON
Satellite 3AS	9600	19200	4FSK	OFF
PCC-4FSK	9600	19200	4FSK	ON
PCC-GMSK	4800	9600 ¹ /NA ²	GMSK	ON
TrimTalk450s (P)	4800	9600 ¹ /NA ²	GMSK	OFF
TrimTalk450s (T)	4800	9600 ¹ /NA ²	GMSK	OFF
PCC-FST	9600	19200	4FSK	ON

¹ For countries without narrow banding regulations

² For countries with narrow banding regulations, for example the USA

Next step

Scan to access **Scan for Base Station**.

Scan for Base Station

This panel provides information about the base stations, with specific types of devices attached, for example a radio, from which real-time corrections are being received. This information can also be useful for finding out if anyone else in the area is using a particular radio channel.

Key	Description
OK	To select the highlighted base station and to continue with the subsequent panel.
Channel-1 and Channel+1	Available for scanning base stations with radios attached. To switch the radio to one channel lower/higher than the current channel. The base stations displayed change to broadcasting on the new channel.

Description of metadata



Metadata	Description
-	ID of available base stations from which a signal is being received. For radios, the base station radios transmitting on the same channel are listed.
Latency(s)	Time delay, in seconds and configured on the base, from when the base collects the data to when the data is transmitted.
RTK format	Format of the data from the base station. Refer to "18.7.1 Configuration of a Rover Real-Time Connection" for more information about data formats.

Channel Settings

Minimum Satel firmware version required:

Satel Radio Model	Firmware Version
M3-TR3	2.0.4.2 or higher
M3-TR4	2.1.0.3 or higher
M3-R3	1.0.9.3 or higher
M3-TR1	3.63 or higher

The information displayed is queried from the Satel radio. The current status is displayed. The information is not stored in Leica Captivate.

Key	Description
Store	To apply and send the new settings to the Satel radio and to return to the panel from where this panel was accessed.
New	To create a channel.  Changes are only applied and send to the Satel radio when pressing Store .
Edit	To edit the highlighted channel.  Changes are only applied and send to the Satel radio when pressing Store .
Delete	To delete the highlighted channel.  Changes are only applied and send to the Satel radio when pressing Store .
More	To change between Spacing (kHz) and Rx Freq. (MHz) on a rover respectively Tx Freq. (MHz) and also Tx Power(mW) on a base.

Description of metadata

Metadata	Description
Channel	Name/number to the channel. Any integer number between -32767 and 32767 is allowed.
Rx Freq. (MHz)	Available on the rover. Receive frequency assigned to the channel in MHz.
Tx Freq. (MHz)	Available on the base. Transmit frequency assigned to the channel in MHz.
Spacing (kHz)	Channel spacing assigned to the channel in kHz.
Tx Power(mW)	Available on the base. Output power assigned to the channel in mW

19.4

RS232

Description

RS232 is a standard serial communication method that is able to transfer data without the need for predefined time slots.

Access

For RTK rover and TS:

- In **Connection Settings**, highlight a connection which has an RS232 device attached. **Control**.

For RTK base:

- In **Base Connection Settings**, highlight a connection which has an RS232 device attached. **Control**.

RS232 Connection

Displayed is the type of device highlighted when this panel was accessed.

19.5

Internet

Description

Internet

The Internet connection allows connection to the Internet to receive real-time data. A GPRS / Internet device must be attached to the instrument.

Requirements

For Internet

- Check **Use Internet connection on GS** in **Internet Connection**.
- An Internet port must be selected in **RTK Base Settings (RTK 1)/RTK Base Settings (RTK 2)** or **RTK Rover Settings**.

Access

For RTK rover:

- In **Connection Settings**, highlight a connection which has an Internet device attached. **Control**.

For RTK base:

- In **Base Connection Settings**, highlight a connection which has an Internet device attached. **Control**.

Internet Port Connection

Internet Port Connection

Internet port: GS Internet 1

Server to use: MyServer

NTRIP mountpoint: -----

Press 'Source' to get a list of mountpoints

OK Source

Key	Description
OK	To accept changes and return to the panel from where this panel was accessed.
Source	Available in rover mode. To access the NTRIP source table.

Description of fields

Field	Option	Description
Internet port	Display only	The name of the Internet port attached to the connection that was highlighted when this page was accessed.
User type	Client	How the instrument operates in the Internet. Available on the base. Must be selected when connecting to a server, for example Ntrip caster or TCP/IP server.

Field	Option	Description
	Server	Available on the base. Must be selected to allow connections from TCP/IP clients, for example GNSS rovers.
IP address	Display only	Available for User type: Server . Current IP address of the GS instrument.
TCP/IP port	Editable field	Available for User type: Server . The port number to which the TCP/IP clients connect for receiving the RTK data stream.
Allow simultaneous connections	1 to 10	Available on the base for User type: Server . Select the number of clients which are allowed to connect to the port.
Server to use	Selectable list	Available on the rover, also on the base for User type: Client . The server to be accessed in the Internet. Open the selectable list to access Server to Connect where new servers can be created and existing servers can be selected or edited.
NTRIP mountpoint	Editable field	Mountpoints are the Ntrip servers sending out real-time data.

Next step

Select **Source** to access **NTRIP Source Table**.

Highlight a mountpoint about which more information is required. This information helps to configure the instrument to use the selected mountpoint as a base. Press **Info** to access **Mountpoint**.

Mountpoint, General page

Description of fields

Field	Option	Description
Identifier	Display only	The name of the selected mountpoint.
Format	Display only	The real-time data format sent out by the mountpoint.
Format details	Display only	Details about Format , for example the RTCM message types including update rates in seconds displayed in brackets.
Authentication method		The type of password protection required for the authorisation to the Ntrip server.
	None	If no password is required.
	Basic	If the password does not require encryption.
	Digest	If the password must be encrypted.
NMEA	Display only	Indicates if the mountpoint must receive GGA NMEA data from the rover in order to compute VRS information.
Charges	Display only	Indicates if charges are currently made for the connection.
Carrier	Display only	The type of carrier message sent out.

Field	Option	Description
System	Display only	The type of satellite system supported by the mountpoint.

Next step

Page changes to the **Location** page.

**Mountpoint,
Location page**

Detailed information about the location of the Mountpoint is displayed.

Next step

Page changes to the **Miscellaneous** page.

**Mountpoint,
Miscellaneous page**

Description of fields

Field	Option	Description
Generator	Display only	The hard- or software generating the data stream.
Compress	Display only	The name of the compression/encryption algorithm.
Bitrate	Display only	The data speed in bits per second.
Information	Display only	Miscellaneous information if available.

Next step

OK to return to the previous panel.

19.6

Configuring the Stations to Dial

19.6.1

Accessing Dial-up Connection List

Description

Dial-up Connection List allows new stations to be created, provides a list of base stations that can be dialled and allows existing stations to be edited. For digital cellular phones of any technology and for modems, the phone numbers of the device at the base station must be known. For a base station to be dialled, a name, the phone number and, if available, the coordinates can be configured.

Access step-by-step

1. In **Connection Settings**, highlight a connection which has a digital cellular phone of any technology or modem attached.
2. **Control.**
3. Open the selectable list for **Dial-up connection**.

Dial-up Connection List

Key	Description
OK	To select the highlighted station and to return to the panel from where this panel was accessed.
New	To create a station. Refer to "19.6.2 Creating / Editing a Station to Dial".
Edit	To edit a station. Refer to "19.6.2 Creating / Editing a Station to Dial".
Delete	To delete the highlighted station.

Description of metadata

Metadata	Description
-	Listed are all available base stations.
Number	Phone number of the station to dial.

19.6.2

Creating / Editing a Station to Dial

Access

In **Dial-up Connection List** press **New** or **Edit**.

New Dial-Up Connection

Key	Description
Store	To return to the panel from where this panel was accessed.
Fn Coord	Available when Use coordinates is checked. To view other coordinate types.

Description of fields

Field	Option	Description
Name	Editable field	A unique name for the new base station to be dialled. The name can be up to 16 characters long and include spaces.
Number	Editable field	The number of the base station to dial. If the survey is taken across country borders it is necessary to input the phone number using standard international dialling codes. For example, + 41123456789. Otherwise it can be input as a standard digital cellular phone number.
Protocol	Analog ISDN v.110 or ISDN v.120	Available for digital cellular phones of GSM technology. The configured protocol of the digital cellular phone of GSM technology. For conventional phone networks. For GSM networks.
Use coordinates	Check box	Check this box to type in the approximate coordinates of the base station.

19.7

Configuring the Server to Connect

19.7.1

Accessing Server to Connect

Description

Server to Connect allows new servers to be created, provides a list of servers that can be accessed in the Internet and allows existing servers to be edited.

Access step-by-step

1. In **Connection Settings**, highlight a connection which has an Internet connection attached.
2. **Control**.
3. Open the selectable list for **Server to use**.

Server to Connect

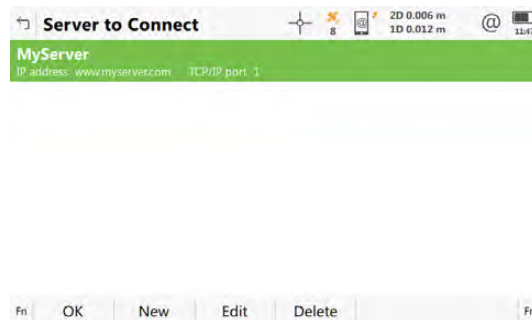

Key	Description
OK	To select the highlighted server and to return to the panel from where this panel was accessed.
New	To create a server. Refer to "19.7.2 Creating / Editing a Server".

Key	Description
Edit	To edit a server. Refer to "19.7.2 Creating / Editing a Server".
Delete	To delete the highlighted server.

Description of metadata

Column	Description
-	Listed are all available servers.
IP address	IP addresses of all available servers.
TCP/IP port	TCP/IP Port numbers of all available servers.

19.7.2

Creating / Editing a Server

Access

In **Server to Connect** press **New** or **Edit**.

New Server, General page

Key	Description
Store	To return to the panel from where this panel was accessed.
Page	To change to another page on this panel.

Description of fields

Field	Option	Description
Server name	Editable field	A unique name for the new server to be accessed.
Address	Editable field	Type in the host name or the IP address of the server to be accessed in the Internet.
Port	Editable field	The port of the Internet server through which the data is provided. Each server has several ports for various services.

Next step

Page changes to the **NTRIP** page.

Description of fields

Field	Option	Description
Use NTRIP with this server	Check box	Check to activate Ntrip.
NTRIP user ID	Editable field	A user ID is required to receive data from to the Ntrip Caster. Contact the Ntrip administrator for information.
NTRIP password	Editable field	A password is required to receive data from the Ntrip Caster. Contact the Ntrip administrator for information.
Display password	Check box	When this box is checked, the password is displayed in the NTRIP password field. When this box is not checked, dots are displayed in the NTRIP password field

Next step

Store to store the settings.

20 Configuration of Devices

20.1 Devices

20.1.1 Overview

Description

Before using any device, it is necessary to configure the interface with which it is used. Refer to "18.1 Accessing Configuration Connections" for information on how to configure the interfaces.

Some devices can be used with different interfaces for different applications. For example:

- For GS: A radio can be used to receive real-time base data but a second radio could also be used to output simultaneous NMEA messages.
- For TS: A radio can be used for remote control with a TS but also to send GeoCOM commands from a computer to a TS.

20.1.2 Digital Cellular Phones

Description

Digital cellular phones comprise of the technologies CDMA and GSM/UMTS.

Typical uses

- To transmit real-time data.
- To receive real-time data.

Example use

1. Base and rover must both be equipped with a digital cellular phone.
 2. Ensure that the digital cellular phone at the base is on.
 3. The rover digital cellular phone contacts the selected base of which the phone number was pre-defined. Refer to "20.3 Creating/Editing a Device".
 4. One rover can dial in to the base digital cellular phone at a time.
 5. As soon as the base digital cellular phone is contacted, real-time data is sent to the rover digital cellular phone that has called.
-  Several digital cellular phone numbers can be pre-defined on the rover. Dialling a different number dials that particular base station.

Requirements for using digital cellular phones

Required	Description
Always required	<ul style="list-style-type: none">• AT command language must be supported by the digital cellular phone.• Working area must be covered by a digital cellular phone network.• The network operator must support data transmission.
Sometimes required	<ul style="list-style-type: none">• SIM card. This SIM card is the same as is normally used in mobile phones. The SIM card must be enabled to transmit data. Contact the service provider to enable the SIM card.• Personal Identification Number• Registration

Supported digital cellular phones

Some digital cellular phones are predefined.

Other digital cellular phones can be used. Their settings must be defined by creating a new digital cellular phone configuration. Refer to "20.3 Creating/Editing a Device". These digital cellular phones must be connected with a cable or Bluetooth. Refer to "D Cables" for information on cables. Please contact the local selling unit or dealer for further information.

Advantages

- Unlimited range of the data channel between base and rover.
- Free of jamming from other users.
- Cheaper in price in the initial costs of buying.

Disadvantages

Fees are charged for the time that the digital cellular phone network is being used.



Base and rover can both be equipped with a digital cellular phone and a radio. On the base, they operate simultaneously. On the rover, use the radio when within radio range of the base and the digital cellular phone when radio reception is not possible.

The internal devices of the GS14/GS16 cannot be used simultaneously.

20.1.3

Modems

Typical uses

- To transmit NMEA messages.
- To transmit real-time data.

Example of use

1. The base is equipped with a modem.
2. The rover is equipped with a digital cellular phone.
3. Ensure that the modem is switched on.
4. The rover digital cellular phone contacts the selected base of which the phone number was pre-defined. Refer to "20.3 Creating/Editing a Device".
5. One rover can dial in to the base modem at a time.
6. As soon as the base modem is contacted, it sends its data to the rover digital cellular phone that has called.



Several modem numbers can be pre-defined on the rover. Dialling a different number changes the base station.

Requirements for using modem

AT command language must be supported by the modem.

Supported modems

Some modems are predefined. Modems must be connected with a cable.

Other modems can be used. Their settings must be defined by creating a new modem configuration. Refer to "20.3 Creating/Editing a Device".

20.1.4

Radios for Real-Time

Typical uses

- To transmit real-time data.
- To receive real-time data.

Example of use

- Base and rover must both be equipped with radios using the same frequency range and the same data format.
- The base radio continuously sends out real-time data until the instrument is turned off, the settings are changed or the radio is detached.
- The rover radio continuously receives real-time data until the instrument is turned off, the settings are changed or the radio is detached.
- Several rovers can receive data from the same base at the same time.
- Several base radios can transmit real-time data simultaneously using different radio channels. Changing to a different radio channel on the rover changes the base from which real-time data is received.

Supported radios

Some radios are predefined.

Other radios can be used. Their settings must be defined by creating a new radio configuration. Refer to "20.3 Creating/Editing a Device". These radios must be connected with a cable.



Base and rover can both be equipped with a digital cellular phone and a radio. On the base, they operate simultaneously. On the rover, use the radio when within radio range of the base and the digital cellular phone when radio reception is not possible.

The internal devices of the GS14/GS16 cannot be used simultaneously.

20.1.5

Radios for Remote Control

Typical uses

- To remote control the TS.
- To transmit data between a TS and computer.

Supported radios

- The default radios used with TS for remote control are the internal radio, the RadioHandle and the external radios TCPS. Set the TS to the correct communication mode to send and receive data and commands using the radio.
- A Communication side cover must be fitted to the TS when operating with the RadioHandle.

User defined radios

Other radios than the default radios can be used. Their settings must be defined by creating a new radio configuration. Refer to "20.3 Creating/Editing a Device". These radios must be connected with a cable. Refer to "D Cables" for information on cables.

20.1.6

RS232

Standard RS232

Standard RS232 is supported by default. The settings are:

Baud rate:	115200	Stop bits:	1
Parity:	None	Flow control:	None
Data bits:	8		

20.1.7

USB

USB

USB is supported on the MS60/TS60. The USB interface on port 1 can be used to:

- connected to the CS using the USB interface.
- configure **GeoCOM Connection** (cable). USB and serial interface are possible.
- configure **GSI Output Connection** (cable). USB and serial interface are possible.
- configure **Export Job Connection** (cable). USB and serial interface are possible.

If cable is selected (serial – RS232), then the USB interface is also available. If USB is selected, the serial interface is also available but with the default respectively previously set parameters.



The IP address of the RNDIS interface of the MS60/TS60 cannot be changed within Leica Captivate. Use Windows CE to change the IP address, for example when connecting two instruments using USB to the same computer.

20.1.8

Hidden Point Measurement Devices

Typical uses

To measure

- distances (reflectorless distance measurements using laser technology)
- angles
- azimuths

to points which are not directly accessible with GNSS, for example house corners or trees. If the device is connected to the instrument, the measurements taken with hidden point measurement devices are directly transferred. If the device is not connected, measurement can be typed in manually to calculate the coordinates of a hidden point.

Example of use

1. An instrument must be a rover with or without real-time settings.
2. A hidden point measurement device is connected to the instrument using cable or Bluetooth.
3. Hidden point measurements are configured and activated.
4. Distances, angles and azimuths are measured to the hidden point with the hidden point measurement device.
5. The measurements are directly transferred to the instrument and displayed in the appropriate fields.



Hidden point measurement devices can be connected in addition to any of the other devices. They can be active at the same time. Changing of ports is not required.

Supported hidden point measurement devices

Some devices are predefined.

Hidden point measurement devices of the same type but with different settings must be defined by creating a new hidden point measurement device. Refer to "20.3 Creating/Editing a Device".

20.1.9

GPRS / Internet Devices

Description

GPRS is a telecommunication standard for transmitting data packages using the Internet Protocol.

When using GPRS technology, charges are made based on the amount of transferred data and not, as per normal digital cellular phones, for the connection time.

Typical uses

To access the Internet with an instrument in order to receive real-time data from the Internet.

Example use



The following is an example use for receiving data from the Internet.

1. Rover must be equipped with a GPRS / Internet device.
2. The GPRS / Internet device accesses the Internet where the rover connects for example to Ntrip.
3. The rover receives real-time corrections via the Internet.

Requirements for using GPRS / Internet devices

- AT command language must be supported by the digital cellular phone.
- **Access Point Name** of a server from the network provider. The APN can be thought of as the home page of a provider supporting GPRS data transfer.
- SIM card. This SIM card is the same as is normally used in mobile phones. The SIM card must be enabled to transmit data. Contact the service provider to enable the SIM card.
- **Personal Identification Number**
- Registration

Supported GPRS / Internet devices

Some GPRS/Internet devices are predefined. Other GPRS capable devices can be used as long as they use AT commands. Their settings must be defined by creating a new device configuration. Refer to "20.3 Creating/Editing a Device". Please contact the local selling unit or dealer for further information.

Advantages

- Unlimited range of the data channel between base and rover.
- Free of jamming from other users.
- Fees are charged for the amount of data being transferred.

20.2

Accessing Devices

Description

Allows devices to be created, edited, selected and deleted.

Access step-by-step

1. For RTK rover and TS:
 - Select **Leica Captivate - Home: Settings\Connections\All other connections.**For RTK base:
 - Select **Leica Captivate - Home: Settings\Connections\All other connections.**
2. Highlight the appropriate interface based on the type of device to be configured. For example, highlight **RTK rover** for a radio configuration.
3. **Edit.**
4. Activate the interface by checking the check box.
5. **Device** to access **Devices.**

Devices

This panel may consist of several pages and provides different devices for selection depending on which interface the panel was accessed from. The functionality described here is always the same.

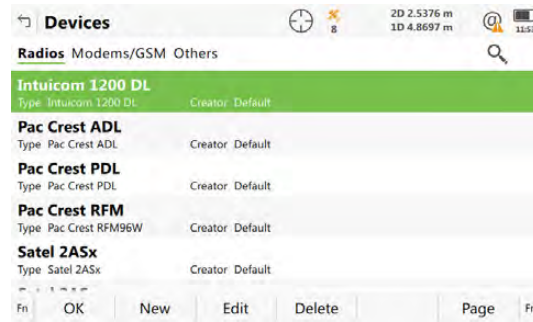

Key	Description
OK	To select the highlighted device and return to the panel from where this panel was accessed.
New	To create a device. Refer to "20.3 Creating/Editing a Device".
Edit	To edit the highlighted device. Refer to "20.3 Creating/Editing a Device".
Delete	To delete the highlighted device.
More	To display information about the type of device and the creator of the device.
Page	To change to another page on this panel.
Fn All or Fn Filter	Available for Internet and Bluetooth devices. To list all devices or to hide devices which are not Internet or Bluetooth capable.
Fn Default	To recall previously deleted default devices and to reset default devices to the default settings.

Description of metadata

Metadata	Description
-	Listed are all available devices.
Type	Type of device defined when creating the device.
Creator	The creator of the device. The creator can be either Default when the device is a default, or User when the device has been created.
	If a Default device is edited by using Edit then its creator is still displayed as Default.

20.3

Creating/Editing a Device

Description

Allows a new device to be configured or an existing device to be edited.

Access

In **Devices**, highlight a device of the same type as the device to be created, from the list. Press **New** or **Edit**.

New Device or Edit Device

New Device

Name: **Intuicom 1200 DL**

Type: **Intuicom 1200 DL**

Baud rate: **38400**

Parity: **None**

Data bits: **8**

Stop bit: **1**

Flow control: **None**

Store

Key	Description
Store	To store the new device and to return to the panel from where this panel was accessed.
AT Msg	Available for digital cellular phones and modems. To configure communication commands.

Description of fields

Field	Option	Description
Name	Editable field	Name of new device.
Type	Display only	Same device type as was highlighted when New or Edit was used.
Baud rate	From 1200 to 230400	Frequency of data transfer from instrument to device in bits per second. Unavailable for CS modem.
Parity	None , Even or Odd	Error checksum at the end of a block of digital data. Unavailable for CS modem.
Data bits	6 , 7 or 8	Number of bits in a block of digital data. Unavailable for CS modem.
Stop bit	1 or 2	Number of bits at the end of a block of digital data. Unavailable for CS modem.
Flow control	None or Flow control	Activates hardware handshake. When the instrument/device is ready for data, it asserts the Ready To Send line indicating it is ready to receive data. The sender at the Clear To Send input reads this line, indicating it is clear to send the data. Available for some phone devices.

Next step

IF the device is a	THEN
radio or device other than digital cellular phone or modem	Store to close the panel and to return to the panel from where this panel was accessed.
digital cellular phone or modem	AT Msg .

AT Command Lines

The AT commands configure the devices. Refer to the manual of device for information about which AT commands must be entered or contact the supplier.

Description of fields

Field	Option	Description
Initialisation 1	Editable field	Initialisation sequence to initialise digital cellular phone/modem. When the device is used, between Initialisation 1 and Initialisation 2 , a check for the PIN is performed.
(continued)	Editable field	Allows the Initialisation 1 , Initialisation 2 or the Dial string to continue onto a new line.
Initialisation 2	Editable field	Initialisation sequence to initialise digital cellular phone/modem.
Dial	Editable field	Dialling string used to dial the phone number of the real-time base.
Hang-up	Editable field	Hangup sequence used to end the network connection.
Escape	Editable field	Escape sequence used to switch to the command mode before using the hangup sequence.
Connect	Editable field	Dialling string used to dial into the Internet.

Next step

Store returns to **New Device** or **Edit Device**.

21

Instrument - Base Settings

21.1

Satellite tracking

Description

The settings on this panel define which satellite system, satellites and satellite signals the instrument uses.

Access

For RTK base:

Select **Leica Captivate - Base: Settings\GS base\Satellite tracking**.



This panel contains the same settings as the RTK rover **Satellite Tracking** panel. Changes made to the settings here in RTK base mode, are reflected in the RTK rover mode and vice versa.

Satellite Tracking, Global page

Key	Description
OK	To accept changes.
Page	To change to another page on this panel.

Description of fields

- Any of the GNSS can only be disabled, if at least one other GNSS is enabled.
- At least one GNSS must be enabled.
- **GPS** can never be disabled on the base station.

Field	Option	Description
GPS	Check box	Defines if the instrument accepts the GPS L1, L2 and L5 signals when tracking satellites. For L2 and L5 the multi-frequency licence is required.
Glonass	Check box	Defines if the instrument accepts GLONASS L1 and L2 signals when tracking satellites.
Galileo	Check box	Defines if the instrument accepts Galileo E1, E5a, E5b and AltBOC signals when tracking satellites.
BeiDou	Check box	Defines if the instrument accepts BeiDou B1 and B2 signals when tracking satellites.
Show message & audio warning, when loss of lock occurs	Check box	Activates an acoustic warning signal and a message given by the instrument when the position is lost.

Next step

Page changes to the **Advanced** page.

Satellite Tracking, Advanced page

Key	Description
OK	To accept changes.

Key	Description
Health	Available for Satellite health: User defined . To configure the satellites used.
Page	To change to another page on this panel.

Description of fields

Field	Option	Description
Cut-off angle	Editable field	Sets the elevation in degrees below which satellite signals are not recorded and are not shown to be tracked. Recommended settings: <ul style="list-style-type: none"> • For real-time: 10°. • For purely post-processing applications: 15°.
DOP limit	None, GDOP, HDOP, PDOP or VDOP	If activated, the limit defined in Limiting value is checked. GNSS positions are unavailable when the limit is exceeded.
Limiting value	Editable field	The maximum acceptable DOP value. Available unless DOP limit: None .
L2C tracking	Always track	L2C signals are always tracked. The system uses the L2C signals instead of L2P signals, if available.
	Automatic	L2 signals which are flagged as unhealthy are not recorded or used for real-time computations.
Satellite health		Sets the satellite tracking behaviour.
		 This setting is remembered when the instrument is turned off.
	Automatic	The instrument monitors incoming satellite signals. Data from signals which are flagged as unhealthy is not recorded or used for real-time computations.
	User defined	Satellites must manually be included/excluded from data recording and real-time computations with Health .

Next step

Health changes to **Satellite Health**.

Satellite Health

The panel contains a page for each GNSS system the receiver is configured to track. The explanations given for the softkeys are valid for all pages.

Key	Description
OK	To accept changes and return to the panel from where this panel was accessed.
Use	To change between the options for the metadata User .

Key	Description
Page	To change to another page on this panel.

Description of metadata

Metadata	Option	Description
-	01 to 50	The Pseudo Random Noise number (GPS, 1 to 32), the Slot ID (GLONASS, 1 to 24) or the Space Vehicle number (Galileo, 1 to 50, and BeiDou, 1 to 37) of the satellites. There is a prefix G for GPS satellites, a prefix R for GLONASS satellites, a prefix E for Galileo satellites and a prefix C for BeiDou satellites.
System	OK, N/A or Unhealthy	Information on the satellite health taken from the almanac. N/A stands for not available.
User	Bad OK Auto	Excludes satellite from tracking. Includes satellite in tracking. Automatic satellite tracking when satellite is healthy.

Next steps

1. **Page** changes to the **Glonass** page, to the **Galileo** page and to the **BeiDou** page, where GLONASS satellites, Galileo and BeiDou satellites used in the survey can be configured.
2. **OK** returns to **Satellite Tracking**.
3. **OK** returns to **Leica Captivate - Home** or **Leica Captivate - Base**.

21.2

GNSS raw data logging

Description

Logged raw observations are used for

- static and kinematic operations. With these operations, raw data is always post-processed in the office. Raw data must therefore be logged on both base and rover instruments.
- real-time operations

to check the work in the office by post-processing.

OR

to fill in gaps when a real-time position could not be calculated in the field, for example, due to problems with the real-time data reception from the reference station or the RTK network provider

Observations must be logged on all instruments which are used for post-processing.

The settings on this panel define the logging of raw observations.

Access

For RTK base:

Select **Leica Captivate - Base: Settings\GS base\GNSS raw data logging**.

GNSS Raw Data Logging

GNSS Raw Data Logging

Log GNSS raw data

Store data on **GS sensor**

Log data when dynamics are **Static**

Log data every **1.0s**

Logging starts when **On accessing Measure app**

Log data to **Leica format (MDB)**

Log GNSS raw data for post-processing in office software

OK

Key	Description
OK	To accept changes.

Description of fields

Field	Option	Description
Log GNSS raw data	Check box	Activates raw data logging.
Log data every	From 0.05 sec to 300.0 sec	Rate at which raw observations are logged. Recommendations: <ul style="list-style-type: none"> For static operations with long baselines and over long time Rate: 15.0 sec or Rate: 30.0 sec. For base stations for post-processed and real-time kinematic rovers, Rate at the base should be the same rate as at the rover.
Log data to	Selectable list	Data can be logged in the Leica proprietary MDB format or in RINEX.

22

Settings - TS instrument

22.1

Measure & target

22.1.1

Measure & Target

Description

The settings on this panel define the active EDM (**E**lectronic **D**istance **M**easurement) and ATRplus (**A**utomatic **T**arget **R**ecognition) settings.



Available options depend on the purchased model, for example with or without ATRplus.

Access

Select **Leica Captivate - Home: Settings\TS instrument\Measure & target**.

Measure & Target

Description

- This panel has two pages - the **Measure** page and the **Setup** page.
- The **Measure** page and **Setup** page contain identical fields.
- The settings made in the **Measure** page are used by all apps and all measurements taken outside of the **Setup** app.
- The settings made in the **Setup** page are only used inside the Setup app.
- Any changes made to the **Measure & Target**, for example using icons or hotkeys, while the Setup app is active, only affect the **SetupMeasure & Target**.
- Any changes made to the **Measure & Target**, for example using icons or hotkeys, while the Setup app is not active, only affect the **MeasureMeasure & Target**.
- When entering the Setup app, the **SetupMeasure & Target** are active.
- When leaving the Setup app, the **MeasureMeasure & Target** are active.
- Both **Measure** and **SetupMeasure & Target** are part of the working styles.



Key	Description
OK	To accept changes and return to Leica Captivate - Home .
Page	To change to another page on this panel.
Fn Test	To access the Measurement Signal Test panel.

Description of fields

Field	Option	Description
Target	Selectable list	Target names as configured in the Targets panel. Allows the measurements of distances to a prism or a tape.
	Any surface	To measure without reflector.
Leica constant	Display only	The additive constant for the selected prism as stored in the software.
Absolute constant	Display only	The current additive constant.
Aim at target	Manually	Measurements are done without any automation. ATRplus search and/or ATRplus measurement are not performed.
	Automatic	Positioning to static prisms. The ATRplus sensor is used for measurements to static prisms. If needed, an ATRplus measurement or ATRplus search is performed after pressing Measure or Distance .
	With lock	The instrument locks onto and follows the moving prism. The ATRplus sensor is used to follow moving prisms and to find prisms after loss of lock. Depending on the setting for Measure distance , single or continuous measurements are performed. Unavailable for SmartStation.
Measure distance	Once	When a single measurement with high precision is required.
	Once & fast	When a single measurement is required but the time to survey must be minimised. The highest accuracy is of less importance. Use this setting for example when performing, "typical" topographical surveys.
	Continuously	When continuous distance measurements are required. Performs a linear interpolation between the previous and following angle measurement, based on the timestamp of the EDM measurement. Using this interpolation procedure, a higher accuracy for all dynamic applications is possible.
	Repeatedly & average	When an average of several measurements is required. Repeats measurements in standard measuring mode. The average distance of Number of distances and the standard deviation for the averaged distance are calculated. Use this setting for example when performing cadastral survey where rigid guidelines must be followed.

Field	Option	Description
	Greater than 4km	When long distances to prisms are needed. Use this setting for example for triangulation measurements.
	Greater than 4km & avg	Whenever long distances to prisms are needed but in addition, average values and standard deviations for multiple precise distance measurements are required. Use this setting for example when performing triangulation measurements within a cadastral survey where rigid guidelines must be followed.
	With highest precision	Available on TS60. Fine measuring for highest precision measurements with prisms.
Number of distances	Editable field	Available if Measure distance: Repeatedly & average or Measure distance: Greater than 4km & avg . Editable fields for the maximum number of distances to be averaged from 2 to 999 distances.
Visibility		Available when a CS20 is connected to a TS15/TS50/TM50/MS50. TS16/TS60/MS60 have integrated ATRplus which automatically adjust the settings for optimal performance.
	Good	If weather conditions are normal, then select this mode.
	Rain & fog	To increase the instrument measuring ability during suboptimal weather conditions. This setting is automatically deactivated when the instrument is turned off.
	Sun & reflections	To increase the instrument measuring ability during incident solar radiation and reflections, for example safety vests. This setting has a considerable influence on the range (restriction 100 - 150 m). This setting is automatically deactivated when the instrument is turned off.
High dynamics at short range	Check box	Available for Aim at target: With lock . Available when a CS20 is connected to a TS15/TS50/TM50/MS50. TS16/TS60/MS60 automatically adjust the settings for optimal performance. When this box is checked, the performance improves for distances less than 20 m to the instrument. The instrument reacts faster to changes in prism speed and direction.

22.1.2

Targets

Description

Each prism type has an absolute constant.

Leica Geosystems prisms are predefined as defaults and can be selected. Additional prisms can be defined.

Default targets

Following default targets are always available on the instrument:

Name	Name in list	Type	Leica constant	Absolute constant
GRZ4, GRZ122	Leica 360° prism	Prism	+23.1 mm	-11.3 mm
GMP111-0	Leica mini 0	Prism	0.0 mm	-34.4 mm
GRZ101	Leica mini 360°	Prism	+30.0 mm	-4.4 mm
GMP101, GMP111	Leica mini prism	Prism	+17.5 mm	-16.9 mm
GZM29, GZM30, GZM31, CPR105	Leica reflective tape	Tape	+34.4 mm	0.0 mm
GPR1, GPR111, GPR113, GPR121, GPH1P	Leica round prism	Prism	0.0 mm	-34.4 mm
-	Any surface	RL	+34.4 mm	0.0 mm
MPR122	MPR122	Prism	+28.1 mm	-6.3 mm



For Machine Control purposes only!

Access

Open the selectable list for **Target** in **Measure & Target**.

Targets

This panel shows information about the additive constant, the target type and the creator of the target.

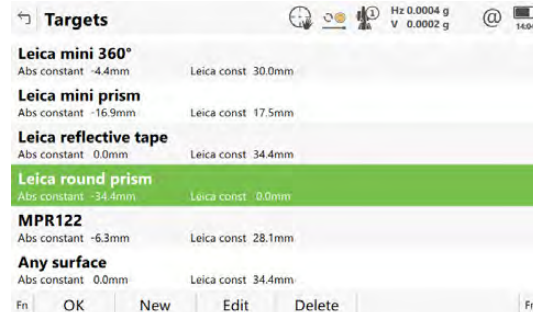

Key	Description
OK	To select the highlighted target and to return to the previous panel.
New	To define a new target. Refer to "22.1.3 Creating/Editing a Target".
Edit	To edit the highlighted target. It is not possible to edit default targets. Refer to "22.1.3 Creating/Editing a Target".
Delete	To delete the highlighted target. It is not possible to delete default targets.
Fn Default	To recall previously deleted default targets and to reset default targets to the default settings. User-defined targets are not affected.

Access

In **Targets**, highlight a target. All constants are copied from this target. Press **New** or **Edit**.

New Target

Key	Description
Store	To store the target.

Description of fields

Field	Option	Description
Name	Editable field	A significant name for the new target.
Type	Prism, Tape or Undefined	The type of target to be defined.
Leica constant	Editable field	The additive constant for the selected prism as stored in the software.  An additive constant of 0.0 mm has been defined for the Leica Geosystems standard targets GPR1, GPR111, and so on. All entered or selected additive constant values are differences to the 0.0 mm based Leica Geosystems TS prism system.
Absolute constant	Editable field	The true additive constant. The additive constant is always in mm.

Field	Option	Description
		<p> The additive constants of non-Leica Geosystems prisms are often given in the true zero prism system. Use the following formula to convert the additive constant to the Leica Geosystems TS prism system. This Leica constant must be entered into the Leica instrument.</p> <p>Formula: True zero constant - 34.4 mm = Leica constant.</p> <p>It is highly recommended to check the additive constant for non-Leica Geosystems prisms on a baseline with an appropriate procedure.</p>
Creator	Editable field	A name of the creator or other comments can be entered.

22.2

Target search

Description

The settings on this panel define

- the size of search windows for prisms to be searched in. The prisms can be searched with PowerSearch in the **PowerSearch window** or with ATR-plus in the **Fine search window**.
- the behaviour of automatic prism search after the target is lost in lock mode.

Access

Select **Leica Captivate - Home: Settings\TS instrument\Target search**.

Target Search, Target prediction page

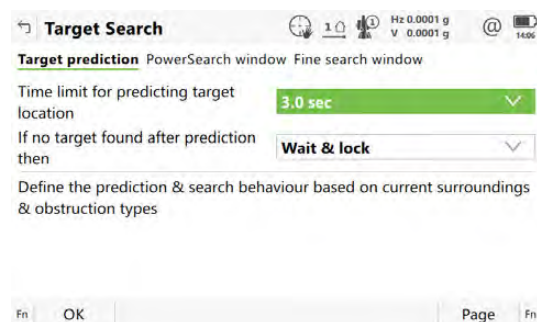

Key	Description
OK	To accept changes and return to Leica Captivate - Home .
Page	To change to another page on this panel.
Fn Default	To recall the default settings.

Description of fields

Field	Option	Description
Time limit for predicting target location	From 1 s to 5 s	If the target is lost when Aim at target: With lock the path of the prism is predicted for the selected number of seconds.
If no target found after prediction then	Wait & lock	Perform no search after prediction.
	Start fine search	Perform search after prediction with ATRplus in a dynamic Fine search window .
	Start Cube-Search	Perform search after prediction with PowerSearch. Activate PowerSearch on the Power-Search window page.
	Turn to last measured point	If the target is lost when Aim at target: With lock , then the instrument turns back to the last stored point. The field of view is disabled while the instrument is repositioning.

Next step

Page changes to the **PowerSearch window** page.

Target Search, PowerSearch window page

Target Search

Target prediction **PowerSearch window** Fine search window

Use PowerSearch window

Hz angle left **0 g**

Hz angle right **0 g**

V angle up **100 g**

V angle down **100 g**

Minimum range **No limit**

Maximum range **No limit**

OK Set Centre Show Page

Key	Description
OK	To accept changes and return to Leica Captivate - Home .
Set	To define new PowerSearch window.
Centre	To centre the PowerSearch window to the current position of the telescope.
Show	To position the telescope to corners of PowerSearch window.
Page	To change to another page on this panel.

Description of fields

Field	Option	Description
Use Power-Search window	Check box	If checked, PowerSearch searches in the defined window.

Field	Option	Description
Hz angle left, Hz angle right, V angle up and V angle down	Display only	The left, right, upper and lower boundaries of the PowerSearch window.
Minimum range	No limit and from 25 m to 175 m	Minimum distance of the search range for the PS window to be defined.
Maximum range	From 25 m to 175 m and No limit	Maximum distance of the search range for the PS window to be defined.

Next step

Page changes to the **Fine search window** page.

Target Search, Fine search window page

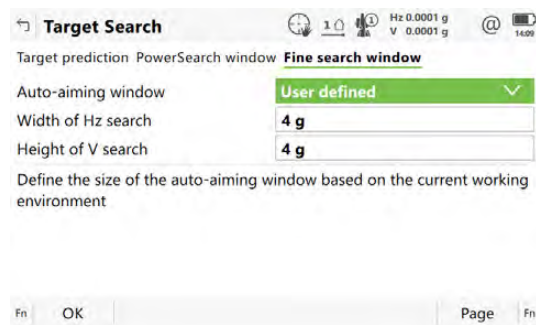

Key	Description
OK	To accept changes and return to Leica Captivate - Home .
Page	To change to another page on this panel.
Fn Default	To recall the default settings.

Description of fields

Field	Option	Description
Auto-aiming window	User defined	Select this option to define the search window manually.
	Ultra fine	Reduces the field of view of the ATRplus. The setting is only applied for Aim at target: Automatic in Measure & Target .
Width of Hz search	Editable field	Horizontal extent of window.
Height of V search	Editable field	Vertical extent of window.

Next step

Page changes to another page on this panel.

22.3

Atmospheric corrections

Description

The settings on this panel define the atmospheric ppm and the refraction. For standard applications, the distance is corrected due to atmospheric influences. The geometrical correction and the projection distortions are set to 0.00. Heights are reduced with the standard refraction coefficient. Refer to the product specific User Manuals for information on calculations.

Access

Select **Leica Captivate - Home: Settings\TS instrument\Atmospheric corrections**.

Atmospheric Corrections, Atmospheric ppm page

The atmospheric distance corrections are derived from the dry air temperature, air pressure or elevation above mean sea level MSL, and the relative air humidity or wet bulb temperature.

Atmospheric Corrections Refraction

Temperature 12.0 °C

Pressure 1013.3 mbar

Humidity 60.0 %

Atmospheric ppm 0.0

Measurement accuracy is increased if the correct temperature, pressure & humidity are entered

Fn OK Page Fn

Key	Description
OK	To accept changes and return to Leica Captivate - Home .
Page	To change to another page on this panel.
Fn P<>E	To change Pressure to Elevation above mean sea level and back.
Fn %<>T'	To change Humidity to Wet-bulb temperature and back.
Fn ppm=0	To set Atmospheric ppm: 0.0 .

Description of fields

Field	Option	Description
Temperature	Editable field	Sets the temperature.
Pressure or Elevation above mean sea level	Editable field	Sets the atmospheric pressure or the elevation above mean sea level dependent on selection.
Humidity or Wet-bulb temperature	Editable field	Sets the relative air humidity or the wet bulb temperature dependent on selection.
Atmospheric ppm	Editable field or display only	The atmospheric ppm is either set or calculated from the values in the previous fields.

Next step

Page changes to the **Refraction** page.

Atmospheric Corrections, Refraction page

The refraction correction is taken into account during the calculation of the height difference.

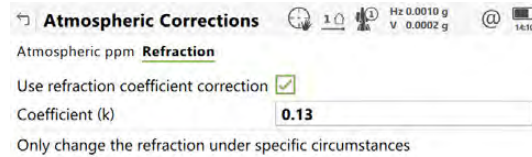

Key	Description
OK	To accept changes and return to Leica Captivate - Home .
Page	To change to another page on this panel.
Fn Default	To recall the default settings.

Description of fields

Field	Option	Description
Use refraction coefficient correction	Check box	If checked, refraction correction is applied to measurements.
Coefficient (k)	Editable field	Refraction coefficient to be used for calculation.

Next step

Page changes to another page.

22.4

Level & compensator

Description

For raw data display and recording, the compensator and the horizontal correction can be deactivated.



The graphical level bubble is displayed correctly for the situation when the first panel is aligned with two footscrews.

Access

Select **Leica Captivate - Home: Settings\TS instrument\Level & compensator**.

Level & Compensator

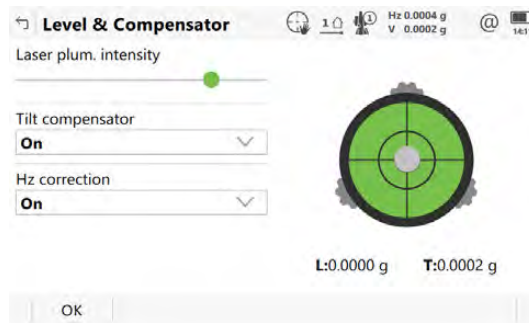

Key	Description
OK	To accept changes and return to Leica Captivate - Home . For a TS remote controlled by a CS: To return to Remote Control .

Description of fields

Field	Option	Description
Laser plum. intensity	Scroll bar	To adjust the intensity of the laser plummet.
Tilt compensator	On	Vertical angles are relative to plumb line. The horizontal angle is corrected for the transversal tilt errors if Hz correction: On .
	Off until restart	Vertical angles are relative to vertical/standing axis. Deactivates the compensator until the instrument is turned off. when the instrument is turned on again, the compensator is activated.
	Off	The mode stays always deactivated. The compensator is deactivated, also after turning off and on the instrument.
Hz correction	On	The horizontal angles are corrected for the line of sight, tilting axis and if Tilt compensator: On transversal tilt errors.
	Off	Horizontal angles are not corrected.

22.5

Lights & accessories

Description

The settings on this panel allow the lights on the instrument to be configured. For motorised instruments, the horizontal/vertical boundaries of a search window can be defined.

Access

Select **Leica Captivate - Home: Settings\TS instrument\Lights & accessories**.

Lights & Accessories, Lights page

This panel is available for motorised instruments.

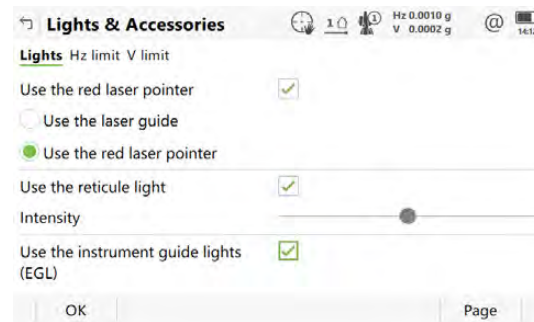

Key	Description
OK	To accept changes and return to Leica Captivate - Home .
Page	To change to another page on this panel.

Description of fields

Field	Option	Description
Use the red laser pointer	Check box	When this box is checked, either the laser guide or the red laser pointer can be activated.
Use the laser guide	Check box	If checked, the laser guide is turned on.
Intensity	From 0 % to 100 %	To adjust the intensity, slide the indicator left and right.
Use the red laser pointer	Check box	If checked, the red laser of the reflectorless EDM is turned on.
Use the reticule light	Check box	If checked, the reticle illumination is turned on.
Intensity	From 0 % to 100 %	To adjust the reticle illumination intensity using the left and right arrow keys.
Use the instrument guide lights (EGL)	Check box	If checked, the Emitting Guide Light (EGL) is turned on. This field is only available if EGL is fitted.
Intensity	From 0 % to 100 %	To adjust the EGL/Laser Guide intensity using the left and right arrow keys.

Next step

Page changes to the **Hz limit** page.

Lights & Accessories, Hz limit page

This panel is available for motorised instruments.

Key	Description
OK	To accept changes and return to Leica Captivate - Home .

Key	Description
Set	To define new search window. Follow the instructions on the panel.
Show	To position the telescope to corners of the search window.
Page	To change to another page on this panel.

Description of fields

Field	Option	Description
Limit Hz movement of instrument	Check box	When this box is checked, horizontal boundaries for the search window can be defined.
Hz begin and Hz end	Editable field	The boundaries of the search window as horizontal angle where the search begins/ends.

Next step

Page changes to the **V limit** page.

Lights & Accessories, V limit page

This panel is available for motorised instruments.

Key	Description
OK	To accept changes and return to Leica Captivate - Home .
Set	To define new search window. Follow the instructions on the panel.
Show	To position the telescope to corners of the search window.
Page	To change to another page on this panel.

Description of fields

Field	Option	Description
Limit V movement of instrument	Check box	When this box is checked, vertical boundaries for the search window can be defined.
Limit movement for	Selectable list	Limits can be set for eyepiece and/or lens.
V begin and V end	Editable field	The boundaries of the search window as vertical angles where the search begins/ends. For eyepiece and lens.

Lights & Accessories, Battery & charging page

This panel is available for MS60/TS60 on the CS when connected to a MS60/TS60.

Key	Description
OK	To accept changes and return to Leica Captivate - Home .

Description of fields

Field	Option	Description
Main power source		Determines the power source to be used when internal and external batteries are attached at the same time.
	Internal battery	Select this setting if an internal battery and an external power source are attached but the internal battery must be used first.
	External power	Select this setting if: <ul style="list-style-type: none">• an internal battery is attached but an external battery is attached later. Then the external power source is used as power source.• an external power source and an internal battery are attached but the external power source must be used.
Charge the internal battery when external power is connected	Check box	If attached, the internal battery is charged from the external power source.

22.6

Cameras



For information on camera and images refer to "32 Camera & Imaging".

22.7

Check & Adjust

22.7.1

Overview

Description

Leica Geosystems instruments are manufactured, assembled and adjusted to the best possible quality. Quick temperature changes, shock or stress can cause deviations and decrease the instrument accuracy. It is therefore recommended to check and adjust the instrument from time to time. This check and adjust can be done in the field by running through specific measurement procedures. The procedures are guided and must be followed carefully and precisely as described in the following chapters. Some other instrument errors and mechanical parts can be adjusted mechanically.

Electronic adjustment

The following instrument errors can be checked and adjusted electronically:

Instrument error	Description
l, t	Compensator longitudinal and transversal index errors
i	Vertical index error, related to the standing axis
c	Horizontal collimation error, also called line-of-sight error
a	Tilting-axis error
ATRplus	ATRplus zero point error for Hz and V - option

Instrument error	Description
Telescope camera	Telescope camera zero point error, relation between principal point of telescope camera and crosshair in telescope in Hz and V - option

If the compensator and the horizontal corrections are activated in the instrument settings, every angle measured in the daily work is corrected automatically. Check whether the tilt correction and the horizontal correction are turned on.

The results are displayed as errors but used with the opposite sign as corrections when applied to measurements.

Mechanical Adjustment

The following instrument parts can be adjusted mechanically:

- Circular level on instrument and tribrach
- Optical plummet - option on tribrach
- Allen screws on tripod

Precise Measurements

To get precise measurements in the daily work, it is important:

- To check and adjust the instrument from time to time.
- To take high precision measurements during the check and adjust procedures.
- To measure targets in two faces. Some of the instrument errors are eliminated by averaging the angles from both faces.



During the manufacturing process, the instrument errors are carefully determined and set to zero. As mentioned above, these errors can change and it is highly recommended to redetermine them in the following situations:

- Before the first use
- Before every high precision survey
- After rough or long transportation
- After long working periods
- After long storage periods
- If the temperature difference between current environment and the temperature at the last calibration is more than 20°C

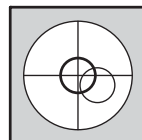

Before determining the instrument errors, the instrument has to be levelled using the electronic level.

The tribrach, the tripod and the underground should be stable and secure from vibrations or other disturbances.



The instrument should be protected from direct sunlight to avoid thermal warming.

It is also recommended to avoid strong heat shimmer and air turbulence. The best conditions are early in the morning or with overcast sky.



Before starting to work, the instrument has to become acclimatised to the ambient temperature. Approximately two minutes per °C of temperature difference from storage to working environment, but at least 15 min, should be taken into account.



Even after adjustment of the ATRplus, the crosshairs may not be positioned exactly on the centre of the prism after an ATRplus measurement has been completed. This outcome is a normal effect. To speed up the ATRplus measurement, the telescope is normally not positioned exactly on the centre of the prism. These small deviations/ATRplus offsets, are calculated individually for each measurement and corrected electronically. The horizontal and vertical angles are corrected twice: first by the determined ATRplus errors for Hz and V, and then by the individual small deviations of the current aiming.

22.7.2

Details on Instrument Errors

Definition

Instrument errors occur, if the standing axis, the tilting axis and the line of sight are not precisely perpendicular to each other.

Horizontal collimation error (c)

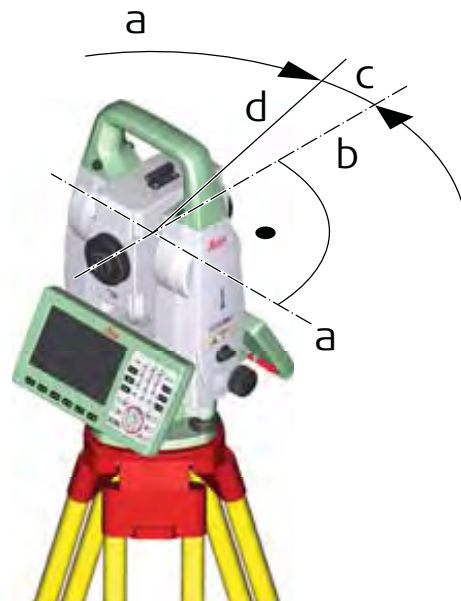

008365_001

- a Tilting axis
- b Line perpendicular to tilting axis
- c Horizontal collimation error (c), also called line-of-sight error
- d Line of sight

The Horizontal collimation error (c) is also called line-of-sight error. The error is caused by the deviation between the optical line of sight, which means the direction in which the crosshairs points and the line perpendicular to the tilting axis. This error affects all horizontal readings and increases with steep sightings.

Tilting-axis error (a)

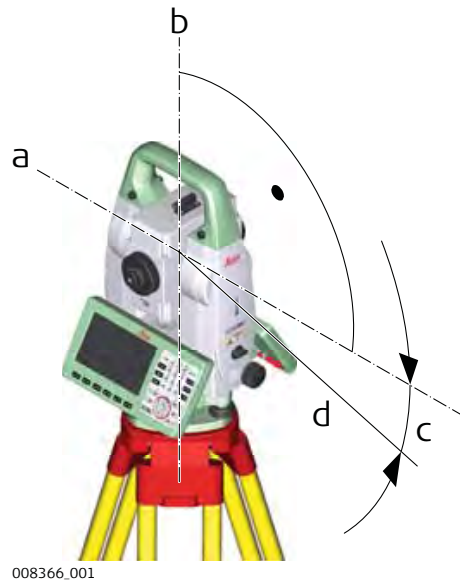

- a Axis perpendicular to the vertical axis
- b Mechanical vertical axis of the instrument, also called standing axis
- c Tilting-axis error
- d Tilting axis

The deviation between the mechanical tilting axis and the line perpendicular to the vertical axis causes the tilting-axis error (a).

This error affects horizontal angles. The effect is zero in the horizon and increases with steep sights. To determine this error, it is necessary to point to a target located significantly below or above the horizontal plane. To avoid influences from the horizontal collimation error (c), the horizontal collimation has to be determined prior to the tilting-axis error.

Vertical index error (i)

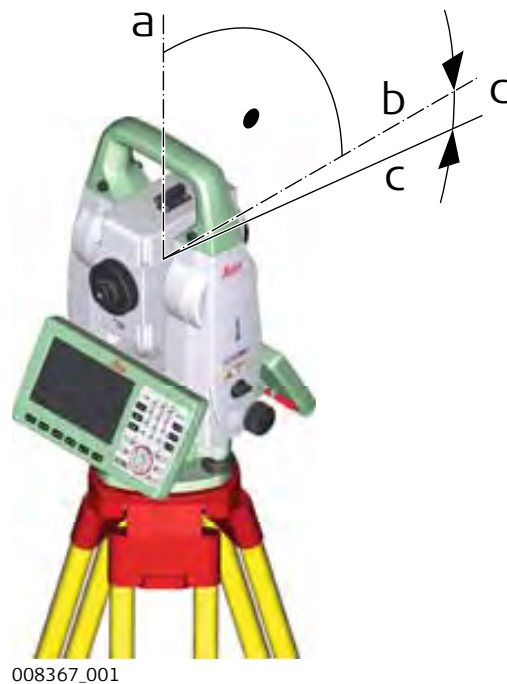

- a Mechanical vertical axis of the instrument, also called standing axis
- b Axis perpendicular to the vertical axis
- c $V = 90^\circ$ reading in a specific face
- d Vertical index error

A vertical index error (i) exists, if the 0° mark of the vertical circle reading does not coincide with the mechanical vertical axis of the instrument, also called standing axis.

The vertical index error (i) is a constant error that affects all vertical angle readings.

Compensator index errors (l, t)

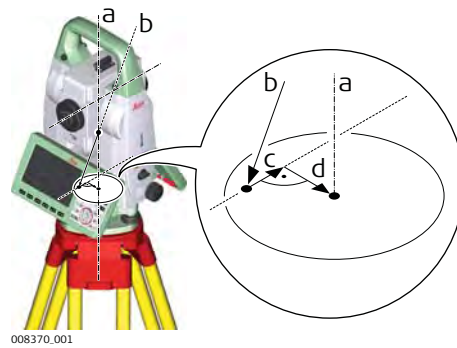

- a Mechanical vertical axis of the instrument, also called standing axis
- b Plumb line
- c Longitudinal component (l) of the compensator index error
- d Transversal component (t) of the compensator index error

The compensator index errors (l, t) occur, if the vertical axis of the instrument and the plumb line are parallel but the zero points of the compensator and the circular level do not coincide. The calibration procedure electronically adjusts the zero point of the compensator.

A longitudinal component in direction of the telescope and a transversal component perpendicular to the telescope define the plane of the dual axis compensator of the instrument.

The longitudinal compensator index error (l) has a similar effect as the vertical index error and affects all vertical angle readings.

The transversal compensator index error (t) is similar to the tilting-axis error. The effect of this error to the horizontal angle readings is 0 at the horizon and increases with steep sightings.

Automatic aiming collimation errors

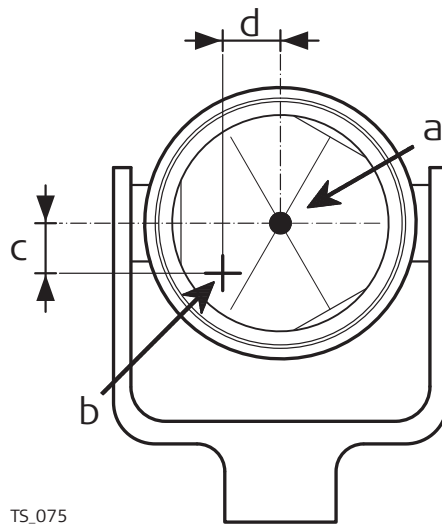

- a Centre of prism
- b Crosshairs
- c V component of ATRplus collimation error
- d Hz component of ATRplus collimation error

The ATRplus collimation error is the angular divergence between the line of sight, which means the direction in which the crosshairs point, and the ATRplus CCD camera axis, which detects the centre of the prism. The horizontal and vertical components of the ATRplus calibration errors correct the horizontal and vertical angles to measure exactly to the centre of the prism.

Telescope camera col- limation error

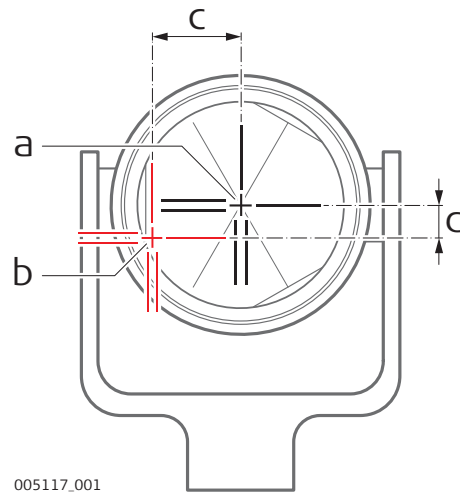

- a Physical crosshairs in the telescope
- b Digital crosshairs in the telescope camera view
- c Hz component of telescope camera collimation error
- d V component of telescope camera collimation error

The telescope camera collimation error is the angular divergence between the physical crosshairs in the telescope and digital crosshairs in the telescope camera view. The determined horizontal and vertical offset values are applied as constant offset to the recent calibration values.

A full telescope camera calibration takes other camera parameters into account, for example focus position, rotation, scale and lens distortion. The full calibration is performed after production and in service.

Summary of Errors to be Adjusted Electronically

Instrument error	Effects Hz	Effects V	Elimination with two face measurement	Automatically corrected with proper adjustment
c - Line of sight error	✓	-	✓	✓
a - Tilting axis error	✓	-	✓	✓
l - Compensator index error	-	✓	✓	✓
t - Compensator index error	✓	-	✓	✓
i - Vertical index error	-	✓	✓	✓
ATRplus Collimation error	✓	✓	-	✓
Co-axial camera collimation error	✓	✓	✓	✓

22.7.3

Accessing the Check & Adjust Wizard

Access

Select **Leica Captivate - Home: Settings\TS instrument\Check & adjust.**

Check & Adjust, What do you want to do?

Key	Description
Next	To accept changes and to continue with the subsequent panel within the wizard.

Next step

IF you want to	THEN
determine the instrument errors	select one of the three available check and adjust procedures and refer to the relevant subchapters.
view the current values	select View the current values . Refer to "22.7.7 Viewing the Current Values".
configure Check & adjust	select Check & adjust settings . Refer to "22.7.8 Configuring Check & adjust"1.
adjust the circular level	Refer to "22.7.9 Adjusting the Circular Level of the Instrument and Tribrach".
inspect the laser plummet	Refer to "22.7.11 Inspecting the Laser Plummet of the Instrument".
adjust the tripod	Refer to "22.7.12 Servicing the Tripod".

22.7.4

Combined Adjustment (l, t, i, c, ATRplus and Telescope Camera)

Access

In **Check & Adjust, What do you want to do?** select **Check & adjust the compensator, index error, line of sight error & automatic target aiming** or **Check & adjust the compensator, index error, line of sight error, automatic target aiming & telescope camera** and press **Next**.

Description

The combined adjustment procedure determines the following instrument errors in one process:

Instrument error	Description
l, t	Compensator longitudinal and transversal index errors
i	Vertical index error, related to the standing axis
c	Horizontal collimation error, also called line of sight error
ATRplus Hz	ATRplus zero point error for horizontal angle
ATRplus V	ATRplus zero point error for vertical angle
Telescope camera Hz	Telescope camera zero point error for horizontal angle - option
Telescope camera V	Telescope camera zero point error for vertical angle - option



Before determining the instrument errors, the instrument has to be:

- levelled up using the electronic level
- protected from direct sunlight
- acclimatised to the ambient temperature, approximately 2 minutes per °C difference compared to the storage place.

**Check & Adjust,
Step 1**

Key	Description
Measure	To measure the target.

Description of fields

Field	Option	Description
Calibrate the automatic target aiming	Check box	When this box is checked, the determination of the ATRplus horizontal and vertical adjustment values is included.
		<p>☞ Use a clean Leica standard prism as target. Do not use a 360° prism.</p> <p>When this box is not checked, the determination of the ATRplus horizontal and vertical adjustment value is excluded.</p>
Calibrate the telescope camera	Check box	When this box is checked, the determination of the telescope camera horizontal and vertical zero point adjustment values is included.
		☞ In Cameras, Overview camera page, Use TS overview camera must be checked.
		☞ A prism is not required to run the procedure.
		☞ Use a clean Leica standard prism as target. Do not use a 360° prism.

1. Aim the telescope accurately at a target at a distance of about 100 m. The target must be positioned within $\pm 9^\circ/\pm 10$ gon of the horizontal plane

☞ The procedure can be started in face I or II.

☞ The fine aiming must be performed manually in both faces.

Measure to measure and to continue to the next panel.

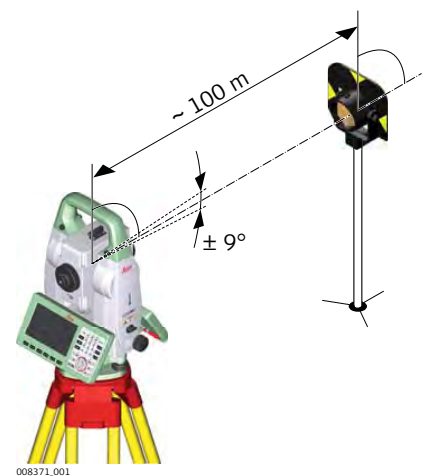

For MS60/TS60:

If **Calibrate the telescope camera** has been checked, aim at the same target accurately with the telescope camera using the view finder and the digital crosshair on the display. **Measure** to measure and to continue to the next panel.

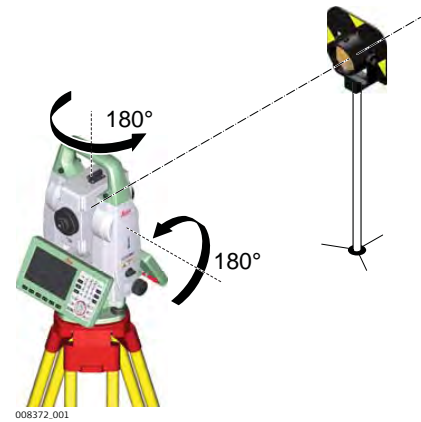

Motorised instruments change automatically to the other face.

Non-motorised instruments guide to the other face using the **Telescope Positioning** panel.

2. **Measure** to measure the same target in the other face and to calculate the instrument errors.



If one or more errors are bigger than the predefined limits, the procedure must be repeated. All measurements of the current run are rejected and are not averaged with the results from previous runs.

Check & Adjust, Step 2

Key	Description
Next	To measure the target.

Description of fields

Field	Option	Description
Number of measurements	Display only	Shows the number of runs. One run consists of a measurement in face I and II.
All other fields	Display only	The standard deviations of the determined adjustment errors are displayed. The standard deviations can be calculated from the second run onwards.

Check & Adjust, It is recommended to repeat the last calibration routine at least three times

Measure at least two more runs.

Next step

IF	THEN
more runs must be added	select Add another calibration loop and press Next .
no more runs must be added	select Finish the calibration & store the results and press Next to accept the measurements and to access the results panel.

Check & Adjust, Results

Select the instrument errors which you want to accept and then store.

Do not check a box to keep the currently used error active on the instrument and rejects the new one.

Key	Description
Back	To return to the previous panel.
Redo	To reject all results and to repeat the complete check and adjust procedure.
Finish	To accept and store the new determined instrument errors, which are selected. If the report sheet recording has been enabled, then the results are written or appended to an existing report sheet.

Description of metadata

Metadata	Description
New	The new determined and averaged instrument errors.
Old	The old adjustment errors, which are currently valid on the instrument.

22.7.5

Tilting Axis Adjustment (a)

Access

In **Check & Adjust, What do you want to do?** select **Check & adjust the tilting axis** and press **Next**.

Description

This adjustment procedure determines the following instrument error:

Instrument error	Description
a	Tilting-axis error



Before determining the tilting-axis error, the instrument has to be:

- levelled up using the electronic level
- protected from direct sunlight
- acclimatised to the ambient temperature, approximately 2 minutes per °C difference compared to the storage place.
- The horizontal collimation error must be determined before.

Check & Adjust, Step 1

Key	Description
Measure	To measure the target.

1. Aim the telescope accurately at a target at a distance of about 100 m. For distances less than 100 m, make sure to point to the target precisely. The target must be positioned within at least $27^\circ/30$ gon above or beneath the horizontal plane.



The procedure can be started in face I or II.



The fine aiming must be performed manually in both faces.

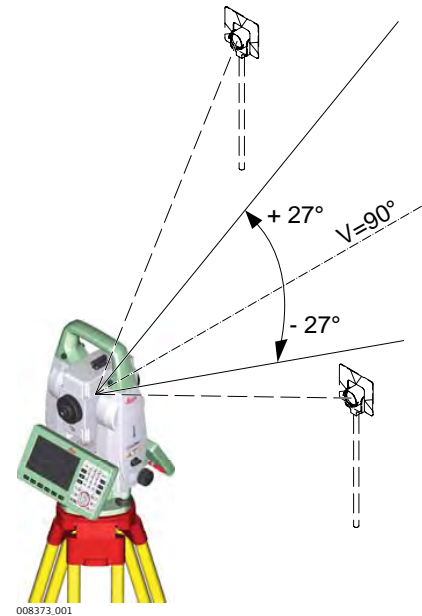

2. **Measure** to measure and to continue to the next panel. Motorised instruments change automatically to the other face.

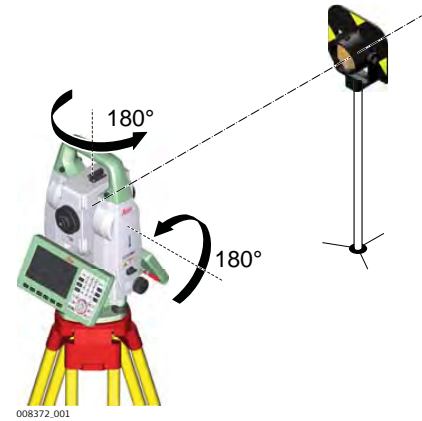

3. Non-motorised instruments guide to the other face using the **Telescope Positioning** panel.

4. **Measure** to measure the same target in the other face and to calculate the instrument errors.



If one or more errors are bigger than the predefined limits, the procedure must be repeated. All measurements of the current run are rejected and are not averaged with the results from previous runs.

Check & Adjust, Step 2

Key	Description
Next	To measure the target.

Description of fields

Field	Option	Description
Number of measurements	Display only	The number of runs. One run consists of a measurement in face I and II.

Field	Option	Description
a T-axis quality (1 σ)	Display only	The standard deviation of the determined tilting-axis error. The standard deviation can be calculated from the second run onwards.

Check & Adjust, It is recommended to repeat the last calibration routine at least three times

Measure at least two more runs.

Next step

IF	THEN
more runs must be added	select Add another calibration loop and press Next .
no more runs must be added	select Finish the calibration & store the results and press Next to accept the measurements and to access the results panel.

Check & Adjust, Results

Key	Description
Back	To return to the previous panel.
Finish	To accept and record the new determined tilting-axis error. If the report recording has been enabled, then the results are written to or appended to an existing report sheet.
Redo	To reject the result and to repeat the complete check and adjust procedure.

Description of fields

Field	Option	Description
New	Display only	The new determined and averaged tilting-axis error.
Old	Display only	The old instrument error, which is valid on the instrument.

22.7.6

Compensator Adjustment (l, t)

Access

In **Check & Adjust, What do you want to do?** select **Check & adjust the compensator** and press **Next**.

Description

The compensator adjustment procedure determines the following instrument errors:

Instrument error	Description
l	Compensator longitudinal index error
t	Compensator transversal index error



Before determining the compensator index errors, the instrument has to be:

- levelled up using the electronic level
- protected from direct sunlight
- acclimatised to the ambient temperature, approximately 2 minutes per °C difference compared to the storage place.

**Check & Adjust,
Make first tilt measurement in any face**

Key	Description
Next	To measure the target.

1. **Measure** to measure the first face. No target has to be aimed at. Motorised instruments change to the other face and release a measurement automatically.



2. Non-motorised instruments guide to the other face using the **Telescope Positioning** panel.

3. **Measure** to release the measurement in the other face.



If one or more errors are bigger than the predefined limits, the procedure must be repeated. All measurements of the current run are rejected and are not averaged with the results from previous runs.

**Check & Adjust,
Step 2**

Key	Description
Next	To measure the target.

Description of fields

Field	Option	Description
Number of measurements	Display only	The number of runs. One run consists of a measurement in face I and II.
I Component quality (1 σ) and t Component quality (1 σ)	Display only	The standard deviations of the determined adjustment errors. The standard deviations can be calculated from the second run onwards.

**Check & Adjust,
It is recommended to repeat the last calibration routine at least three times**

Measure at least two more runs.

Next step

IF	THEN
more runs must be added	select Add another calibration loop and press Next .

IF	THEN
no more runs must be added	select Finish the calibration & store the results and press Next to accept the measurements and to access the results panel.

Check & Adjust, Results

Key	Description
Back	To return to the previous panel.
Redo	To reject all results and to repeat the complete check and adjust procedure.
Finish	To accept and record the new determined instrument errors. If the report sheet recording has been enabled, then the results are written and appended to an existing report sheet.

Description of metadata

Metadata	Option	Description
New	Display only	The new determined and averaged instrument errors.
Old	Display only	The old instrument errors, which are currently valid on the instrument.

22.7.7

Viewing the Current Values

Access

In **Check & Adjust, What do you want to do?** select **View the current values** and press **Next**.

Check & Adjust

Check & Adjust		
i Component	Current[g] 0.0000	Accuracy[g] -----
		Int T[°C] 0
t Component	Current[g] 0.0000	Accuracy[g] -----
		Int T[°C] 0
j V-index	Current[g] 0.0000	Accuracy[g] -----
		Int T[°C] 0
c Hz-collimation	Current[g] 0.0000	Accuracy[g] -----
		Int T[°C] 0
a T-axis	Current[g] 0.0000	Accuracy[g] -----
		Int T[°C] 0
ATR Hz	Current[g] 0.0000	Accuracy[g] -----
		Int T[°C] 0

Key	Description
OK	To return to Check & Adjust, What do you want to do?
More	To display information about the date of the determination, the standard deviation of the errors and the temperature during the determination.



The temperature of the environment around the instrument can differ from the temperature shown on the panel as it is the internal temperature of the instrument.

22.7.8

Configuring Check & adjust

Access

In **Check & Adjust**, **What do you want to do?** select **Check & adjust settings** and press **Next**.

Check & Adjust

Key	Description
Next	To accept changes and to continue with the subsequent panel within the wizard.
Back	To return to the previous panel.

Description of options

Option	Description
Every 2 weeks, Once a month, Every 3 months, Twice a year or Once a year	If one or more adjustment values were determined longer ago than the time specified with this parameter, then a reminder message is displayed each time the instrument is turned on. The reminder helps to redetermine the instrument errors regularly.
Never	A reminder message to readjust the instrument is never displayed. This setting is not recommended.

Next step

Next to change to the **Report sheet** panel.

22.7.9

Adjusting the Circular Level of the Instrument and Tribrach

Adjusting the Circular Level Step-by-Step

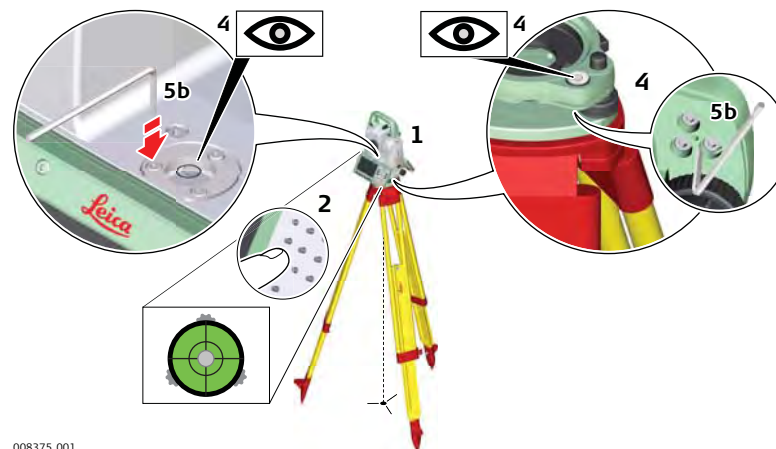

008375_001

1. Place and secure the instrument into the tribrach and onto a tripod.
2. Using the tribrach footscrews, level the instrument with the electronic level.
3. Select **Settings\TS instrument\Level & compensator** to access the **Level & Compensator** panel.

4. Check the position of the circular level on the instrument and tribrach.
-
5.
 - a If both circular levels are centred, no adjustments are necessary
 - b If one or both circular levels are not centred, adjust as follows:

Instrument: If it extends beyond the circle, use the supplied allen key to centre it with the adjustment screws. Turn the instrument by 200 gon (180°). Repeat the adjustment procedure if the circular level does not stay centred.

Tribrach: If it extends beyond the circle, use the supplied allen key to centre it with the adjustment screws.

☞ After the adjustments, all adjusting screws must have the same tightening tension and no adjusting screw should be loose.

22.7.10

Adjusting the Circular Level of the Prism Pole

Adjusting the Circular Level Step-by-Step

1. Suspend a plumb line.
2. Use a pole bipod, to align the prism pole parallel to the plumb line.
3. Check the position of the circular level on the prism pole.
4.
 - a If the circular level is centred, no adjustment is necessary.
 - b If the circular level is not centred, use an allen key to centre it with the adjustment screws.

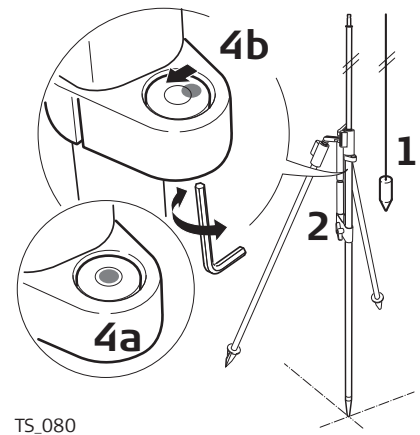

☞ After the adjustments, all adjusting screws must have the same tightening tension and no adjusting screw should be loose.

22.7.11

Inspecting the Laser Plummet of the Instrument



The laser plummet is located in the vertical axis of the instrument. Under normal conditions of use, the laser plummet does not need adjusting. If an adjustment is necessary due to external influences, return the instrument to any Leica Geosystems authorised service workshop.

Inspecting the Laser Plummet Step-by-Step

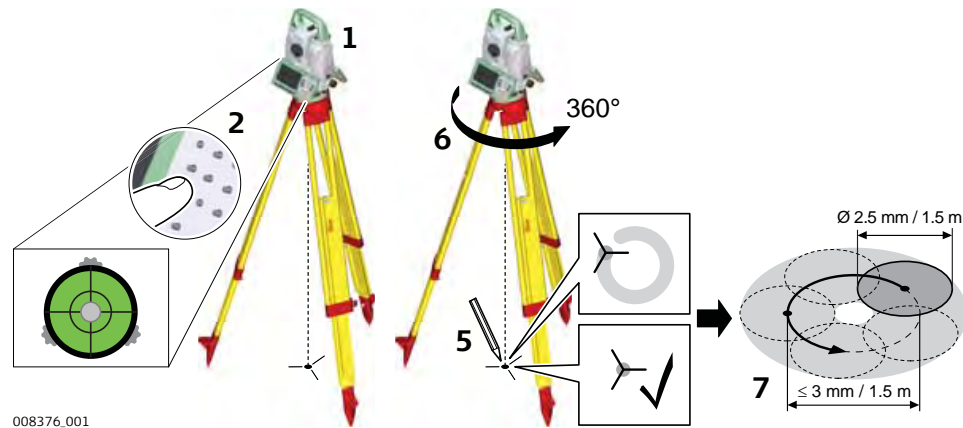

008376_001

The following table explains the most common settings.

1. Place and secure the instrument into the tribrach and onto a tripod.
 2. Using the tribrach footscrews, level the instrument with the electronic level.
 3. Select **Settings\TS instrument\Level & compensator** to access the **Level & Compensator** panel.
 4. The laser plummet is switched on when the **Level & Compensator** panel is entered. Adjust the laser plummet intensity. Inspection of the laser plummet should be carried out on a bright, smooth and horizontal surface, like a sheet of paper.
 5. Mark the centre of the red dot on the ground.
 6. Turn the instrument through 360° slowly, carefully observing the movement of the red laser dot.
- 👉 The maximum diameter of the circular movement described by the centre of the laser point must not exceed 3 mm at a distance of 1.5 m.
7. If the centre of the laser dot describes a perceptible circular movement, or moves more than 3 mm away from the point which was first marked, an adjustment may be required. Inform your nearest Leica Geosystems authorised service centre. Depending on brightness and surface, the diameter of the laser dot can vary. At 1.5 m, it is about 2.5 mm.

22.7.12

Servicing the Tripod

Servicing the Tripod Step-by-Step

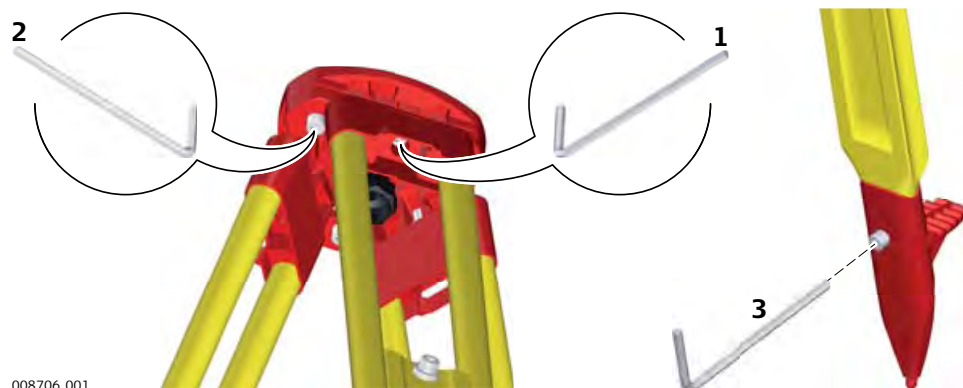

008706_001

The following table explains the most common settings.



The connections between metal and timber components must always be firm and tight.

-
1. Tighten the leg cap screws moderately, with the supplied allen key.
 2. Tighten the articulated joints on the tripod head enough to keep the tripod legs open when lifting the tripod off the ground.
 3. Tighten the allen screws of the tripod legs.
-

23

Settings - GS Sensor

23.1

Satellite tracking

Description

The settings on this panel define which satellite system, satellites and satellite signals the instrument uses.

Access

Select **Leica Captivate - Home: Settings\GS Sensor\Satellite tracking**.

Satellite Tracking, Global page

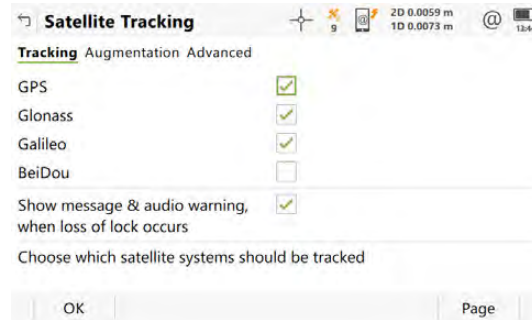

Key	Description
OK	To accept changes.
Page	To change to another page on this panel.

Description of fields

- Any of the GNSS can only be disabled, if at least one other GNSS is enabled.
- At least one GNSS must be enabled.
- **GPS** can never be disabled on the base station.

Field	Option	Description
GPS	Check box	Defines if the instrument accepts the GPS L1, L2 and L5 signals when tracking satellites. For L2 and L5 the multi-frequency licence is required.
Glonass	Check box	Defines if the instrument accepts GLONASS L1 and L2 signals when tracking satellites.
Galileo	Check box	Defines if the instrument accepts Galileo E1, E5a, E5b and AltBOC signals when tracking satellites.
BeiDou	Check box	Defines if the instrument accepts BeiDou B1 and B2 signals when tracking satellites.
Show message & audio warning, when loss of lock occurs	Check box	Activates an acoustic warning signal and a message given by the instrument when the position is lost.

Next step



Page changes to the **Augmentation** page.

Satellite Tracking, Augmentation page

Available on CS20 and CS35 when connected to GS10/GS15/GS14/GS16/GS25.

Key	Description
OK	To accept changes.
Page	To change to another page on this panel.

Description of fields

Field	Option	Description
Use SmartLink	Check box	<p>Available for GS10/GS15/GS16/GS25.</p> <p>Unavailable:</p> <ul style="list-style-type: none">• For Rate: 0.05 sec (20 Hz) configured in GNSS Raw Data Logging.• On GS instruments with measurement engines other than OEM7. Check the information provided for the field ME HW version in About Leica Captivate, GS sensor page. Refer to "30 Settings - About Leica Captivate". Or use the Web-server. <p>Defines if the instrument accepts L-Band tracking to receive correction data coming from Terrastar satellites. Terrastar is a GNSS augmentation service working with geostationary broadcast satellites. If the SmartLink licence is available the system calculates a PPP solution. RTK outages are bridged as long as needed.</p> <p>Use SmartLink to work for longer without the consistent usage of the RTK infrastructure.</p> <p> The settings in Satellite Tracking are not changed.</p> <p> The SmartLink functionality is licenced.</p>
Use SmartLink fill	Check box	<p>Similar to Use SmartLink. Available for GS10/GS15/GS16/GS25. If the SmartLink fill licence is available the system bridges RTK outages for 10 minutes.</p>

Field	Option	Description
		<p>☞ GPS L5, Galileo E5a/E5b/AltBOC and BeiDou B2 satellite signals are unavailable in Use SmartLink fill mode for GS instruments with measurement engines other than OEM7. Check the information provided for the field ME HW version in About Leica Captivate, GS sensor page. Refer to "30 Settings -About Leica Captivate". Or use the Webserver.</p>
Reference frame	Selectable list	<p>Available for a valid SmartLink licence. Select the reference frame of the coordinate system in use. A PPP solution is independent from a reference station or network and therefore the link to the reference frame of the used coordinate system is not given any more. The coordinates needs to be transformed into the reference frame of the coordinate system.</p> <p>☞ The usage of an incorrect reference frame can create a position error bigger than the accuracy of a PPP solution (> 6 cm).</p>

Next step

Page changes to the **Advanced** page.

Satellite Tracking, Advanced page

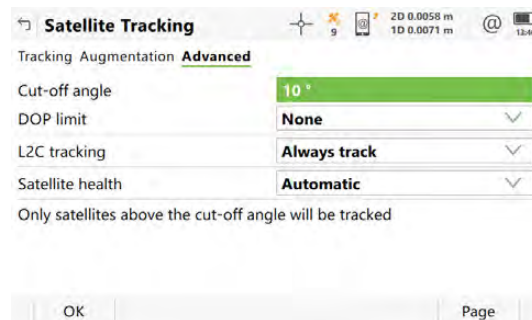

Key	Description
OK	To accept changes.
Health	Available for Satellite health: User defined . To configure the satellites used.
Page	To change to another page on this panel.

Description of fields

Field	Option	Description
Cut-off angle	Editable field	Sets the elevation in degrees below which satellite signals are not recorded and are not shown to be tracked. Recommended settings: <ul style="list-style-type: none"> • For real-time: 10°. • For purely post-processing applications: 15°.
DOP limit	None, GDOP, HDOP, PDOP or VDOP	If activated, the limit defined in Limiting value is checked. GNSS positions are unavailable when the limit is exceeded.
Limiting value	Editable field	The maximum acceptable DOP value. Available unless DOP limit: None .
L2C tracking	Always track	L2C signals are always tracked. The system uses the L2C signals instead of L2P signals, if available.
	Automatic	L2 signals which are flagged as unhealthy are not recorded or used for real-time computations.
Satellite health		Sets the satellite tracking behaviour.
		 This setting is remembered when the instrument is turned off.
	Automatic	The instrument monitors incoming satellite signals. Data from signals which are flagged as unhealthy is not recorded or used for real-time computations.
	User defined	Satellites must manually be included/excluded from data recording and real-time computations with Health .

Next step

Health changes to **Satellite Health**.

Satellite Health

The panel contains a page for each GNSS system the receiver is configured to track. The explanations given for the softkeys are valid for all pages.

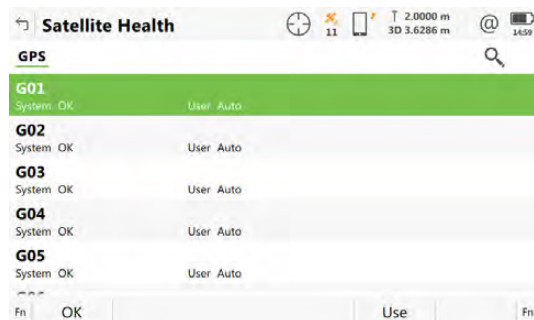

Key	Description
OK	To accept changes and return to the panel from where this panel was accessed.
Use	To change between the options for the metadata User .
Page	To change to another page on this panel.

Description of metadata

Metadata	Option	Description
-	01 to 50	The Pseudo Random Noise number (GPS, 1 to 32), the Slot ID (GLONASS, 1 to 24) or the Space Vehicle number (Galileo, 1 to 50, and BeiDou, 1 to 37) of the satellites. There is a prefix G for GPS satellites, a prefix R for GLONASS satellites, a prefix E for Galileo satellites and a prefix C for BeiDou satellites.
System	OK, N/A or Unhealthy	Information on the satellite health taken from the almanac. N/A stands for not available.
User	Bad OK Auto	Excludes satellite from tracking. Includes satellite in tracking. Automatic satellite tracking when satellite is healthy.

Next steps

1. **Page** changes to the **Glomass** page, to the **Galileo** page and to the **BeiDou** page, where GLONASS satellites, Galileo and BeiDou satellites used in the survey can be configured.
2. **OK** returns to **Satellite Tracking**.
3. **OK** returns to **Leica Captivate - Home** or **Leica Captivate - Base**.

23.2

Antenna heights

23.2.1

Antenna Heights

Access

Select **Leica Captivate - Home: Settings\GS Sensor\Antenna heights**.

Antenna Heights

Antenna Heights

Rover antenna: **GS15 Pole**

Vertical offset: **0.0000 m**

Antenna height when measuring points: **2.0000 m**

Use offset for moving antenna:

Show antenna type when starting an app:

Ensure to choose the correct antenna type.

OK

Key	Description
OK	To return to the Leica Captivate - Home .

Description of fields for the External page

Field	Option	Description
Rover antenna	Selectable list	Leica Geosystems antennas are predefined as default and can be selected from the list. Default antennas contain an elevation-dependent correction model. New antenna correction models can be set up and transferred to the instrument using Infinity. Open the list to define or edit antennas. Refer to "23.2.2 Antennas".
Vertical offset	Display only	The vertical antenna offset for the selected antenna.
Antenna height when measuring points	Editable field	Sets the default antenna height for the current working style. This height is then also the default antenna height during the use of apps. The antenna height can still be changed during a survey. The initial value depends on the selected antenna. Unavailable for SmartStation. The height is added in the Setup and Measure app.
Use offset for moving antenna	Check box	When unchecked, the moving antenna height is considered the same as the default antenna height.
Show antenna type when starting an app	Check box	When this box is checked and an app with measurement functionality is started, the configured antenna type and offset are displayed in an information window.
Offset	Editable field	When the check box Use offset for moving antenna is checked: Sets the offset to the default antenna height for auto points and for the moving part of a track when logging raw observations.

23.2.2

Antennas

Description

Listed are antennas in the instrument's internal memory.

Access

Open the selectable list for **Rover antenna** in **Antenna Heights**.

Antennas

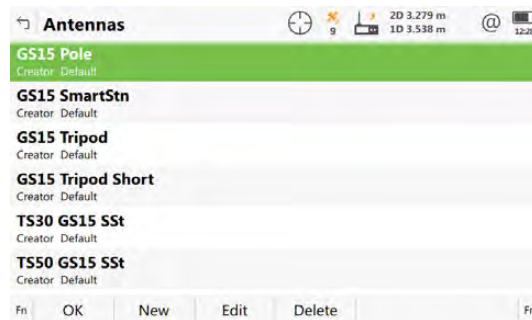

Key	Description
OK	To select the highlighted antenna and to return to the previous panel.
New	To define a new antenna. Refer to "23.2.3 Creating/Editing an Antenna".
Edit	To edit the highlighted antenna. It is not possible to edit default antennas. Refer to "23.2.3 Creating/Editing an Antenna".
Delete	To delete the highlighted antenna.
Fn Default	To recall previously deleted default antennas and to reset default antennas to the default settings. User-defined antennas are not affected.

23.2.3

Creating/Editing an Antenna

Access

In **Antennas**, highlight an antenna. All offsets are copied from this antenna. Press **New** or **Edit**.

New Antenna or Edit Antenna, General page

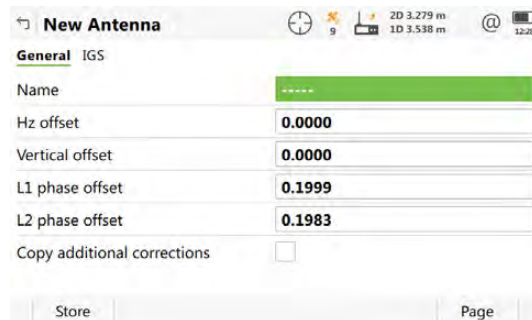

Key	Description
Store	To store the antenna.
Page	To change to another page on this panel.

Description of fields

Field	Option	Description
Name	Editable field	A unique name for the new antenna.
Hz offset	Editable field	Horizontal offset of measurement reference point.

Field	Option	Description
Vertical offset	Editable field	Vertical offset of measurement reference point.
L1 phase offset	Editable field	Offset of L1 phase centre.
L2 phase offset	Editable field	Offset of L2 phase centre.
Copy additional corrections	Check box	Allows extra corrections to be copied from the antenna which was highlighted before this panel was accessed.

Next step

Page changes to the **IGS** page.

New Antenna or Edit Antenna, IGS page

The combination of values typed in here provides a unique standardised ID for the antenna being used.

Description of fields

Field	Option	Description
IGS name	Editable field	The International GPS/GNSS Service name of the antenna.
Serial number	Editable field	The serial number of the antenna.
Setup number	Editable field	The setup number of the antenna. Identifies the version number of the current calibration.

Next step

Store stores the new antenna.

23.3

GNSS raw data logging

Description

Logged raw observations are used for

- static and kinematic operations. With these operations, raw data is always post-processed in the office. Raw data must therefore be logged on both base and rover instruments.
- real-time operations
 - to check the work in the office by post-processing.

OR

to fill in gaps when a real-time position could not be calculated in the field, for example, due to problems with the real-time data reception from the reference station or the RTK network provider

Observations must be logged on all instruments which are used for post-processing.

The settings on this panel define the logging of raw observations.

Access

- The licence for raw data logging is required to log GNSS raw data on the GS, CS or TS instrument.
- The licence for RINEX logging is required to log RINEX data on the GS or CS. RINEX data cannot be logged on the TS instrument.

The licence key can only be loaded from an SD card using the Webserver or myWorld@Leica Geosystems.

Select **Leica Captivate - Home: Settings\GS Sensor\GNSS raw data logging**.

GNSS Raw Data Logging

Key	Description
OK	To accept changes.

Description of fields

Field	Option	Description
Log GNSS raw data	Check box	Activates raw data logging. Not possible on GS18 when Use tilt compensation: On is set in Tilt Compensation .
Store data on	CS controller or GS sensor	Data can either be logged to the field controller or to the GS. For GS08plus, data can only be logged to the field controller.
	TS instrument or GS sensor	For SmartStation, data can either be logged to the TS or to the GS.
Log data when dynamics are	Static	Raw observation logging during static intervals when occupying a point. The instrument has to be stationary. Available for SmartStation.
	Static & kinematic	Raw observation logging during static and moving intervals. For post-processed kinematic rover operations. Unavailable for SmartStation.
	Kinematic	Raw observation logging during moving intervals. For post-processed kinematic antenna operations. Unavailable for SmartStation.

Field	Option	Description
Rate	From 0.05 sec to 300.0 sec	<p>Rate at which raw observations are logged. For Rate: 0.05 sec, the use of Use SmartLink is disabled (Satellite Tracking, Augmentation page).</p> <p>For GS08plus logging rates of 0.2 s and slower are supported.</p> <p>Recommendations:</p> <ul style="list-style-type: none"> • The maximum logging rate using Bluetooth on the field controller is 0.2 s. • For static operations with long baselines and over long time Rate: 15.0 sec or Rate: 30.0 sec. • For base stations for post-processed and real-time kinematic rovers, Rate at the base should be the same rate as at the rover. • For initialisation while static and occupying distinct points in kinematic chains Rate between 0.1 sec and 2.0 sec.
Logging starts when	Selectable list	<p>Available for Store data on: GS sensor. Data logging can start as soon as the instrument is turned on or only while in the Measure app.</p> <p>For GS08plus, data can only be logged with the Measure app.</p>
Log data to	Selectable list	<p>Unavailable for SmartStation.</p> <p>Available for Store data on: GS sensor and Log data when dynamics are: Static. Data can be logged in the Leica proprietary MDB format or in RINEX.</p> <p>For GS08plus, this field is available for Log data when dynamics are: Static.</p>

23.4

Tilt compensation

Access

For GS18 when operating as RTK rover:

Select **Leica Captivate - Home: Settings\GS Sensor\Tilt compensation**.

Tilt Compensation

Key	Description
OK	To accept changes.

Description of fields

Field	Option	Description
Use tilt compensation	Check box	<p>When this box is checked, the pole can be held in a slanting position over the point to be measured without checking the circular bubble on the pole.</p> <p>Measurements are reliable and accurate even if the pole is not levelled as the tilt values are calculated by an Inertial Measurement Unit. Tilt values contain information about the 3D position of the pole.</p> <p>The measurements are immune to magnetic disturbances as there is no magnetometer used.</p> <p>Tilt compensation also works with Navigated and Code solutions. High accuracy positions are recommended to speed up the tilt compensation initialization.</p> <p>Raw data logging is turned off when tilt compensation is on.</p> <p>When measuring a point, the pole tip must be stable on the point while the pole should be in slight movement. Tilt compensation is indicated by an icon and the Tilt LED and is maintained by natural pole movement, for example while moving to the next point to be measured.</p> <p>Advantages:</p> <ul style="list-style-type: none"> • No need to level the pole • Faster surveying procedure <p>☞ The GS18 can work without connection to the data logger and keeps the setting after turning off and on.</p>

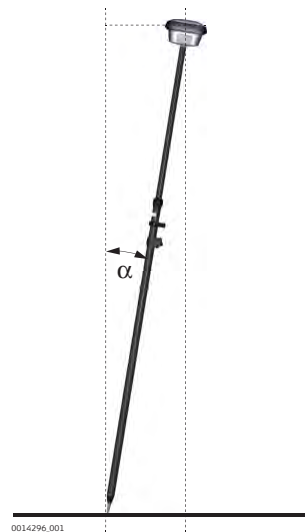

α Tilt

Field	Option	Description
		When this box is not checked, the pole must be held vertically over the survey mark using the circular bubble on the pole.

24.1

Overview

Description

The height of the GNSS antenna above a point consists of three components:

- the vertical or slope height reading,
- the vertical offset,
- the vertical phase centre offset.

For most operations, pre-configured standard settings in the instrument can be used. They automatically take the vertical phase centre offsets into account.

Vertical or slope height

Only vertical antenna heights measured to the **Antenna Reference Plane** are accepted.

Measurements required

This table is an overview of required measurements depending on antennas, setup and accessories. All former Leica antenna types are supported.

IF the antenna is	AND the accessories are	AND the setup is	THEN the measurements required are
Leica antenna, for example GS15	standard Leica	tripod or tripod short	vertical height from height hook
Leica antenna, for example GS15	standard Leica	pole	none. Value is 2.00 m (as indicated on the pole)
Leica antenna, for example GS15	standard Leica	pillar	vertical height to the MRP.
Leica antenna, for example GS15	non-Leica	any	<ul style="list-style-type: none"> • vertical height to the MRP. • possibly vertical offset.
non-Leica antenna	standard Leica OR non-Leica	any	<ul style="list-style-type: none"> • vertical height to the MRP. • possibly vertical offset. • phase centre offsets. • horizontal offset if a slope height reading.

Vertical phase centre offsets

For Leica antennas:

Are handled automatically in the standard antenna records.

For non-Leica antennas:

Can be stored in a newly created antenna record.

OR

Antenna records including azimuth and elevation-dependent corrections must be created using Infinity or imported using the ANTEX format.

The antenna calibrations to determine the phase centre offsets of all Leica antennas were executed by Geo++® GmbH.

24.2

Antenna Reference Planes, ARP

General

The **Antenna Reference Plane**

- is where the antenna heights are measured to.
- is where the phase centre offsets refer to.
- varies for different antennas.

GS15

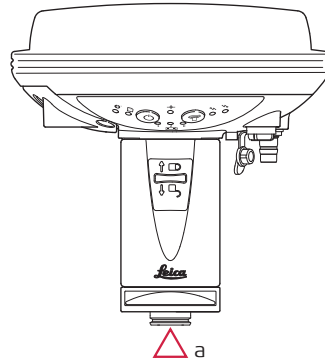

- a The mechanical reference plane is the underside of the threaded metal insert.

GS16/GS14/GS08plus

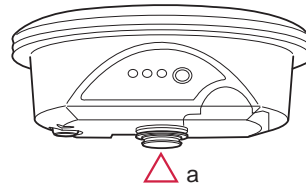

- a The Antenna Reference Plane is the underside of the thread.

GS18



- a Antenna reference plane (ARP)

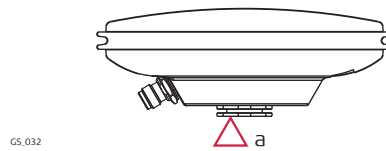

- a The Antenna Reference Plane is the underside of the threaded metal insert.

24.3

Determining Antenna Heights

24.3.1

Pillar Setup



- One of the Leica standard antennas is used, for example GS15. All former Leica antenna types are supported.
- Leica standard accessories are used.

Pillar setup

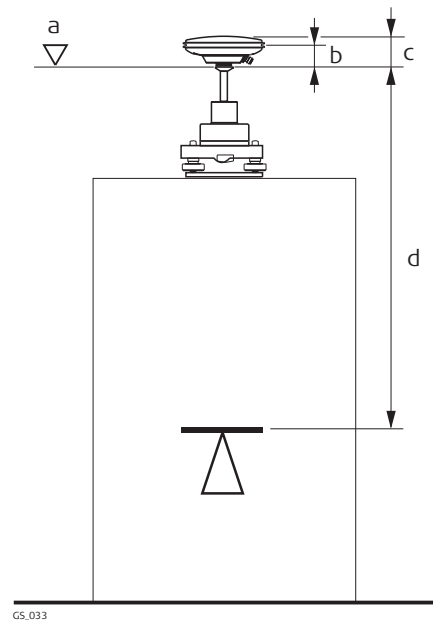

- a Antenna Reference Plane (ARP)
 b Vertical phase centre offset for L1
 c Vertical phase centre offset for L2
 d Vertical height reading

Vertical offset = 0.00 m

Vertical height reading

The vertical height reading is the height difference between the pillar benchmark and the Antenna Reference Plane of the antenna. Normally, it is determined indirectly by levelling.

Determine the antenna height step-by-step

Sometimes, it is difficult to measure to the MRP directly.

1. Determine the height difference between the pillar benchmark and a surface on the carrier.
2. Look up the height difference between this surface on the carrier and where the MRP of the antenna sits on the carrier.
3. Add the values determined in step 1. and 2., to get the **vertical height reading**.
4. For Leica standard antennas plus accessories, the **vertical offset** is 0.00 m.

Carrier and adapter dimensions

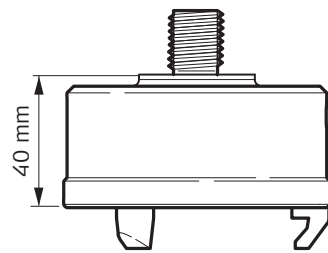

GS.038

GRT247 carrier, preferred for GS15 - **Tripod Short** setup

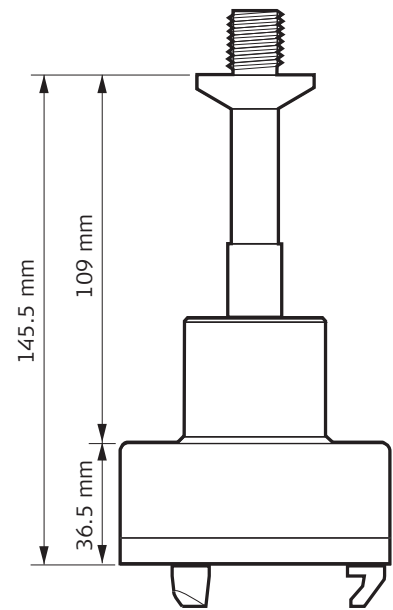

GS.036

GRT146 carrier - **Tripod** setup

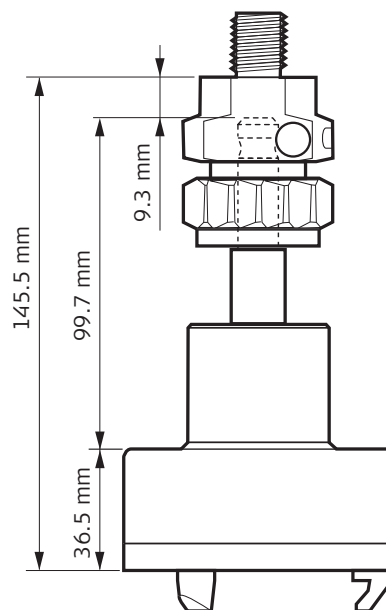

GS.037

GRT144 carrier with GAD31 screw-to-stub adapter - **Tripod** setup

Next step

- At the beginning of a survey, enter the vertical height reading into the instrument.
- The vertical offset of 0.00 m is stored in the antenna setup record for a pillar setup and will automatically be taken into account.
- Refer to 24.1 Overview for the vertical phase centre offsets.



For carriers other than those shown in the diagram above, the dimensions must be determined.



Except for Leica standard antennas plus accessories, the vertical offset must be measured. This value must be entered in the antenna setup record.

24.3.2

Tripod Setup



- One of the Leica standard antennas is used, for example GS15. All former Leica antenna types are supported.
- Leica standard accessories are used.

Tripod setup

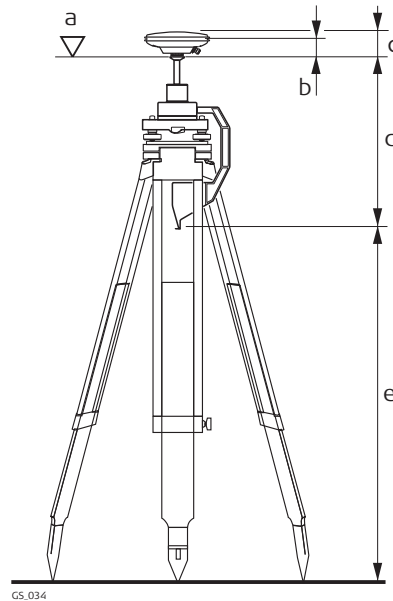

- a Antenna Reference Plane
- b Vertical phase centre offset for L1
- c Vertical phase centre offset for L2
- d Vertical offset
- e Vertical height reading

Vertical height reading

The vertical height reading is the height difference between the ground mark and the bottom end of the height hook. It is determined using the height hook.

Determine the antenna height step-by-step

1. Determine the **vertical height reading** using the height hook.
2. For Leica standard antennas plus accessories, the **vertical offset** is 0.36 m for a **Tripod** setup and 0.2545 m for a **Tripod Short** setup.

Next step

- Determine the antenna type.
- At the beginning of a survey, enter the vertical height reading into the instrument.
- The vertical offset is stored in the antenna setup record for all tripod setups and will automatically be taken into account. It does not need to be entered.
- Refer to 24.1 Overview for the vertical phase centre offsets.



For other than the carriers shown in the diagram above, the dimensions must be determined, the vertical offset must be adapted and entered into a new antenna record.



For other height measurement devices than the height hook, the dimensions must be determined and the vertical offset must be adapted.



For other than Leica standard antennas, the vertical offset must be measured. It must be entered in the antenna setup record.

24.3.3

Pole Setup



- One of the Leica standard antennas is used, for example GS15. All former Leica antenna types are supported.
- Leica standard accessories are used.

Pole setup

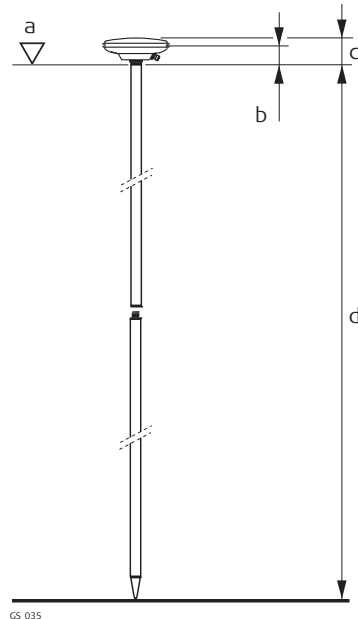

- a Antenna Reference Plane
- b Vertical phase centre offset for L1
- c Vertical phase centre offset for L2
- d Vertical height reading, 2.00 m for the fully extended Leica telescopic pole.

Vertical offset = 0.00 m

Vertical height reading

The vertical height reading is the height difference between the bottom end and the top end of the pole. Usually, this height difference is a fixed value.

Next step

- At the beginning of a survey, enter the vertical height reading into the instrument. A standard rover configuration with a standard antenna setup record for a pole setup uses the value of 2.00 m already as default.
- The vertical offset of 0.00 m is stored in the antenna setup record for a pole setup and will automatically be taken into account. It does not need to be entered.
- Refer to 24.1 Overview for the vertical phase centre offsets.



For other than the Leica standard poles, the dimensions must be determined.



For other than Leica standard antennas, the vertical offset must be measured. It must be entered in the antenna setup record.



- For a SmartStation setup, select the SmartStation antenna in use. This setting depends on both the used GS and the used TS instrument. The setting ensures that the correct vertical offset is applied to the antenna heights.
- For a SmartStation setup, the antenna height value in the Measure panel must equal the value for **Instrument height**. **Instrument height** is seen in the preceding **Choose Setup Point**.
- Leica standard accessories are used.

SmartStation setup

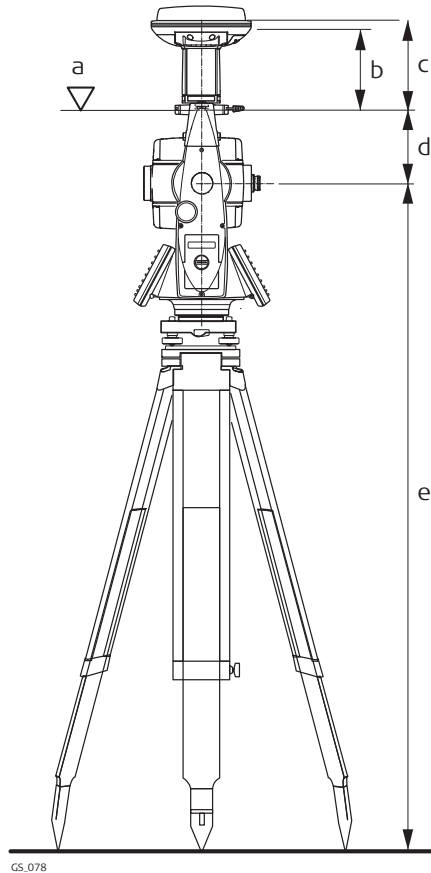

- a Antenna Reference Plane
- b Vertical phase centre offset for L1
- c Vertical phase centre offset for L2
- d Vertical offset
- e Instrument height reading

25

Settings - Point storage

25.1

Duplicate points

Access

Select **Leica Captivate - Home: Settings\Point storage\Duplicate points**.

Duplicate Points

In order to check measurements, the same point can be measured more than once. If activated, an average or an absolute difference is calculated.

The averaging is always done by using TS and GS.

Description of fields

Field	Option	Description
When a point is stored with same point ID as existing point	Check the average	Computes the average for the position and the height. Points exceeding the defined limits are marked with ! on the Mean page.
	Check the abs diff	Computes the absolute differences between two points selected from a list of measured points which are all stored with the same point ID.
	Don't check	Averaging is turned off. No other fields are available.
Method	Weighted	Calculates a weighted average
	No weighting	Calculates an arithmetic average.
Limit in position and Limit in height	Editable field	The acceptable difference for the position and height components. Available for When a point is stored with same point ID as existing point: Check the average .
From Easting to Cartesian Z	Editable fields	The acceptable absolute differences for each coordinate component. Available for When a point is stored with same point ID as existing point: Check the abs diff .

25.2

Prompt before storing

Access

Select **Leica Captivate - Home: Settings\Point storage\Prompt before storing**.

Prompt Before Storing, GS and TS page

Check a box if you want to be asked for input/selection when storing a point with **Store**.

Enter the Following

This panel is displayed when prompting is configured in **Prompt Before Storing** and when storing a point with **Store** or **Measure**.



Only the fields relating to the ticked check boxes in **Prompt Before Storing** are shown.

25.3

GS quality control

Description

The settings on this panel define the limits for coordinate quality accepted for point occupations.

Access

Select **Leica Captivate - Home: Settings\Point storage\GS quality control**.

GS Quality Control, General page

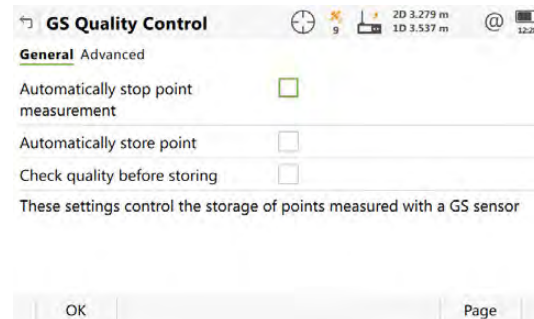

Key	Description
OK	To accept changes.
Parameter	To configure the time interval after which a point occupation can be stopped automatically.
Page	To change to another page on this panel.

Description of fields

Field	Option	Description
Automatically stop point measurement	Check box	Activates a selectable list for the stop criteria. Stops the measurements automatically when the parameter defined for Stop measurement based on reaches 100 %.
Stop measurement based on		Defines the method used for Automatically stop point measurement . The setting determines the computation and value to be shown in the Measure panel. Parameters for the selected method are defined with Parameter .
	Accuracy or Positions	Available when working with real-time device. Records observations between pressing Measure and Stop . Recommended for normal real-time applications. Refer to the diagram below.

Field	Option	Description
	Instantaneous	Records the time tag when Measure is pressed. A coordinate is interpolated between the positions at the neighbouring two epochs to filter out effects of slight movement. Recommended when measuring positions of objects while the antenna is moving very fast. Example: Measuring the position of lamp-posts by driving in a car along the road and pressing Measure when the car is next to the lamppost. Refer to the diagram below.
	Stop & go indicator	Available when raw data logging is configured. The occupation time is based on a user-defined baseline length, the number of satellites and the GDOP.
	Time, Observations or Number of satellites	Available when working without real-time device and when raw data are recorded for post-processing.
Automatically store point	Check box	Stores points automatically after stopping the point occupation. If Automatically stop point measurement and Automatically store point are checked, then points are recorded by pressing one key.
Check quality before storing	Check box	If activated, the limit defined in Tolerance is checked before storing a point. A warning signal is given when the limit is exceeded.
Check	Position only, Height only or Position & height	The type of coordinate quality to be checked before storing a point.
Tolerance	Editable field	The maximum acceptable coordinate quality.

Stop measurement based on: Accuracy or Positions

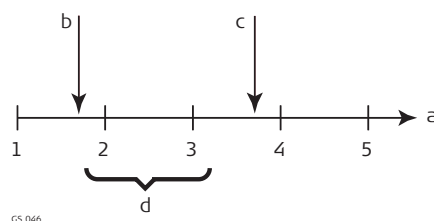

- a Time in epochs
- b **Measure** pressed
- c **Stop** pressed
- d Post-processed coordinates computed by averaging resulting positions of epochs 2 and 3

Stop measurement based on: Instantaneous

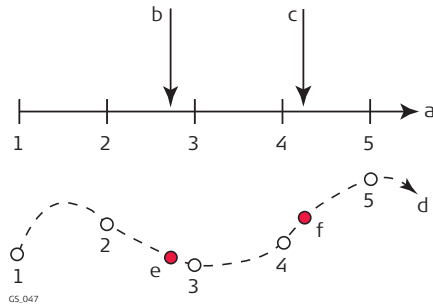

- a Time in epochs
- b **Measure** pressed and point coordinates interpolated based on epochs 2 and 3
- c **Measure** pressed and point coordinates interpolated based on epochs 4 and 5
- d Plan view
- e **Measure** pressed and point coordinates interpolated based on epochs 2 and 3
- f **Measure** pressed and point coordinates interpolated based on epochs 4 and 5

Next step

IF parameters for stop criteria	THEN
are not to be configured	Page changes to the Advanced page.
are to be configured	Parameter changes to Parameters for Auto Stop or Real-Time Stop Criteria .

GS Quality Control, Advanced page

Description of fields

Field	Option	Description
Automatically start measuring point on entering the Measure app	No	Starts point occupation when pressing Measure .
	Yes	Starts point occupation automatically when entering the Measure panel. All subsequent points must be occupied by pressing Measure .
	Timed	Starts point occupation automatically at a certain time.

Next step

OK closes the panel.

Parameters for Auto Stop

The parameters shown on this panel depend on the setting for **Stop measurement based on**.

Key	Description
OK	To accept changes.

Description of fields

Field	Option	Description
Time at point	Editable fields	Sets the required observation time for each point. Counting time starts when Measure is pressed. The instrument stops measuring when the set length of time is reached.
Number of obs	Editable fields	Sets the required number of observations that are to be recorded at each point. Counting observations starts when Measure is pressed. The instrument stops measuring when the set number of observations is reached.
At logging rate	Display only	Displays the rate at which static raw observations are logged as configured.
8+ satellites for, 7 satellites for, 6 satellites for, 5 satellites for and 4 satellites for	Editable field	Sets the required observation time depending on the number of satellites available. Counting time starts when Measure is pressed. The instrument stops measuring when the set length of time for a certain number of satellites is reached. Should the number of available satellites change during observation, the observations already recorded are taken into account.
Baseline length	Selectable list	Used for the calculation of the occupation time for Stop measurement based on: Stop & go indicator .
Extend occupation time by factor of	From 1.0 to 5.0	The factor extends the point occupation time recommended by the software. It directly influences the occupation time shown in Time at point in Measure .

Next step

1. **OK** closes the panel.

2. **OK** returns to the panel from where **Parameters for Auto Stop** was accessed.

Observation time depending on the number of satellites available

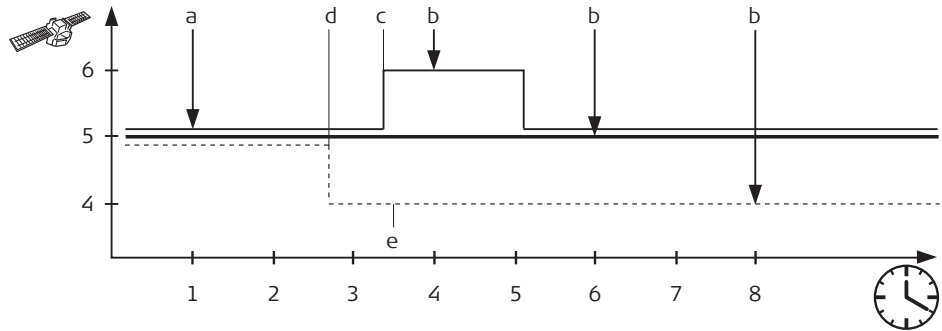

GS_048

- Measure** is pressed. Counting time starts.
- Observation is stopped.
- 40 % for six satellites.
- 30 % for five satellites.
- 30 % for four satellites.

Thin line represents **6 satellites for: 3 min.**

Bold line represents **5 satellites for: 5 min.**

Dashed line represents **4 satellites for: 7 min.**

Real-Time Stop Criteria

The parameters shown on this panel depend on the setting for **Stop measurement based on**.

Real-Time Stop Criteria 🕒 📶 📶 2D 3.278 m @ 🔋 10 3.537 m 12:28

Enter the values to be reached to automatically stop the point measurement

Position quality better than

Height quality better than

For a min number of positions

Positions

Position update

Key	Description
OK	To accept changes.

Description of fields

Field	Option	Description
Position quality better than and Height quality better than	Editable field	Sets the maximum position and height qualities for each point occupation. Calculating the qualities starts when Measure is pressed. The instrument stops measuring when the position and height qualities are both less than the configured values.

Field	Option	Description
Positions	Editable field	Raw data is logged for a minimum number of positions even when the Position quality better than and Height quality better than is already less than the specified maximum.
Position update	Display only	Displays the value for GS position update rate as configured in Screen, Audio & Text Input, Screen page.
Number of positions	Editable field	Sets the number the positions which must be observed before the instrument stops measuring. Counting the number of positions starts when Measure is pressed.
Baseline length	Selectable list	Used for the calculation of the occupation time for Stop measurement based on: Stop & go indicator .

Next step

OK closes the panel.

25.4

TS offsets & checks

Description

Offsets

The offset values are applied to measured points. The Offset function allows offset points to be determined, for instance when the reflector cannot be set up directly on a point. Transverse, longitudinal and/or elevation offsets can be defined from the reflector position to the offset point. All the displayed and recorded measurement data is in relation to the offset point.

Repeat measurement checks

The instrument can be configured to monitor sequentially stored measurements and to notify the user if the coordinates lie within a defined range of each other.

If configured, the X,Y coordinates of a point being stored can be compared to the coordinates of the last previously stored point. If the difference is less than the defined position tolerance then a warning is shown. It can now be decided whether to store the point or not.

If configured, backsight target points and resection target points which were measured during the setup procedure are then also checked in this manner.

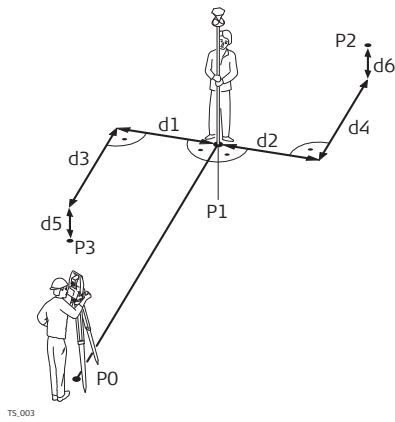

- P0 Setup
- P1 Current position
- P2 Offset point
- P3 Offset point
- d1 Offset cross left
- d2 Offset cross right
- d3 Offset length toward instrument
- d4 Offset length away from instrument
- d5 Offset height down
- d6 Offset height up

Access

Select **Leica Captivate - Home: Settings\Point storage\TS offsets & checks.**

TS Offsets & Checks, Target offsets page

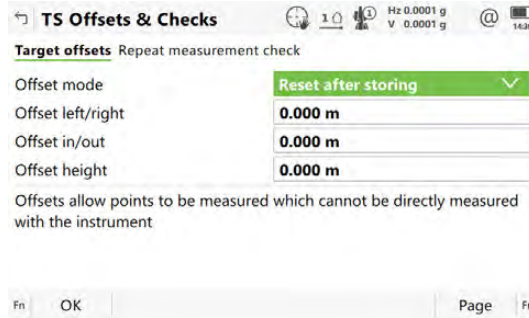

Key	Description
OK	To accept changes and return to Leica Captivate - Home .
Offset=0	To set all offsets to 0.000.
Page	To change to another page on this panel.

Description of fields

Field	Option	Description
Offset mode	Reset after storing	The offset values are reset to 0.000 after a point is measured with Store or Measure .
	Permanent	The offset values are applied to every measured point until reset or changed.
Offset left/right	Editable field	Sets cross offset of target point, perpendicular to the line of sight.
Offset in/out	Editable field	Sets length offset of target point, in the direction of the line of sight.
Offset height	Editable field	Sets height offset of target point.

Next step

Page changes to another page.

TS Offsets & Checks, Repeat measurement check page

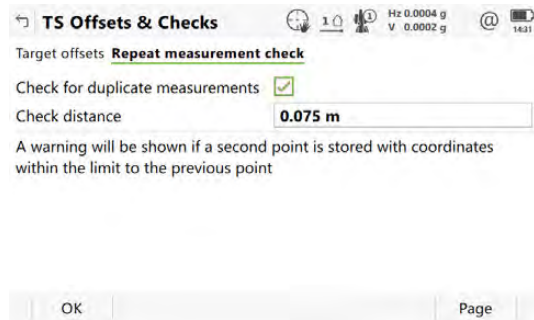

Key	Description
OK	To accept changes and return to Leica Captivate - Home .
Page	To change to another page on this panel.

Description of fields

Field	Option	Description
Check for duplicate measurements	Check box	If checked, target checking is activated.
Check distance	Editable field	The position tolerance. The units are defined in Settings\System\Regional .

Next step

Page changes to another page.

26 Settings - Customisation

26.1 Working style wizard

26.1.1 Overview

Description

The software has many configurable parameters and functions which are user-definable to suit their preferred method of working. These preferred settings can be saved as a Working Style.

Using the wizard, all the settings can be defined at once. Alternatively, all panels of this wizard can also be accessed individually.

Default working style

A default working style exists on the instrument. It uses standard settings for most applications. The default working style can be edited or deleted. It is always possible to restore the default working style by formatting the internal memory.

User defined working styles

New working styles can be created. The working style wizard assists in editing working styles.

26.1.2 Accessing the Working Style Wizard

Access

Select **Leica Captivate - Home: Settings\Customisation\Working style wizard**.

Working Style Wizard

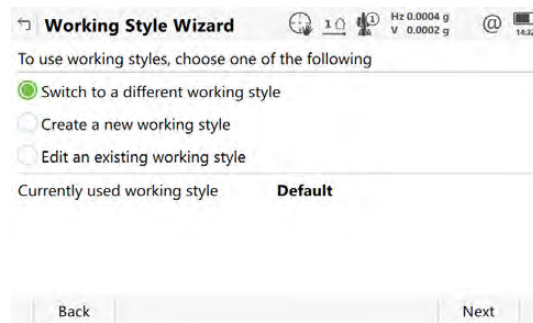

Key	Description
Back	To return to the previous panel.
Next	To accept changes and to continue with the subsequent panel within the wizard.

Next step

IF you want to	THEN
select a different set of settings	select Switch to a different working style , press Next and continue with "26.1.3 Choosing a Different Working Style".
create a set of settings	select Create a new working style , press Next and continue with "26.1.4 Creating a New Working Style".

IF you want to

edit an existing set of settings

THENselect **Edit an existing working style**, press **Next** and continue with "26.1.5 Editing a Working Style".**26.1.3****Choosing a Different Working Style****Working Style Wizard, Choose the working style to be used**

Select an existing working style from the selectable list.

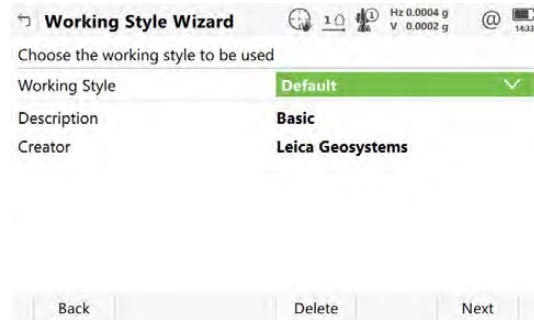

Key	Description
Back	To return to the previous panel.
Delete	To delete the highlighted working style.
Next	To accept changes and to continue with the subsequent panel within the wizard.

26.1.4**Creating a New Working Style****Working Style Wizard, Enter the working style details**

Type in the name and a description for the new working style.

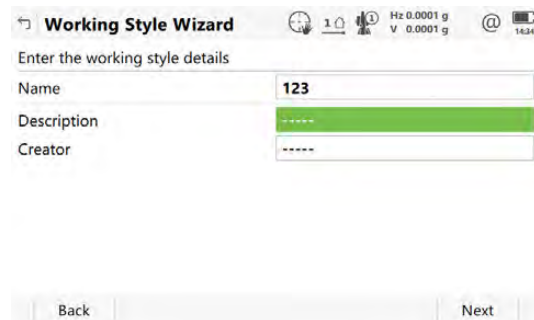

Key	Description
Back	To return to the previous panel.
Next	To accept changes and to continue with the subsequent panel within the wizard.

26.1.5

Editing a Working Style

Working Style Wizard, Choose the working style to be edited

Select the working style to be edited from the selectable list.

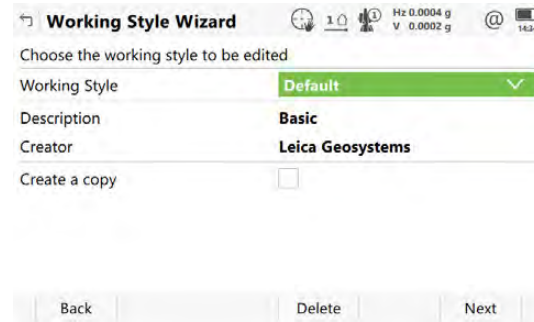

Key	Description
Back	To return to the previous panel.
Delete	To delete the working style currently shown in the selectable list immediately.
Next	To accept changes and to continue with the subsequent panel within the wizard.

Description of fields

Field	Option	Description
Create a copy	Check box	When this box is checked, a copy of the highlighted working style is created before the editing process starts.

26.2

User defined pages

Description

Display settings define the parameters shown on a page on the Measure panel.

Four pages are definable.

Page	Description
Page 1	Always shown on the Measure panel.
Page 2	Can be shown or hidden on the Measure panel.
Page 3	Can be shown or hidden on the Measure panel.

The settings on this panel define the layout of the four pages.

Access

Select **Leica Captivate - Home: Settings\Customisation\User defined pages**.

User Defined Pages, TS and GS page

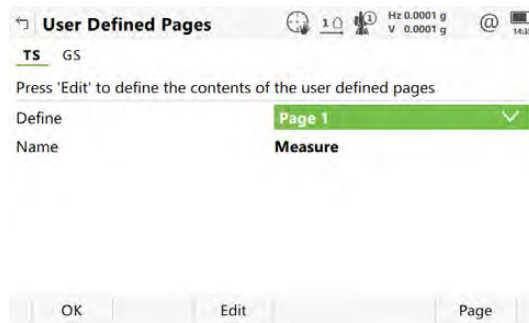

Key	Description
OK	To accept changes and return to Leica Captivate - Home .
Edit	To configure the selected page.
Page	To change to another page on this panel.

Description of fields

Field	Option	Description
Define	Page 1, 2 or 3	Selected page.
Name	Display only	The name of the selected page.

Next step

Highlight the page and **Edit** to access **Page Settings**.

Page Settings

Key	Description
OK	To accept changes and to return to previous panel.
Clear	To set all fields to Unused line .
Fn Default	To recall the default settings.

Description of fields

Field	Option	Description
Name	Editable field	The name of the page.
1st line	Display only	Fixed to Point ID .
2nd line to 16th line	Angle right	For each line, one of the following options can be selected. For TS: Displays the horizontal angle difference between the backsight point and the current telescope position.

Field	Option	Description
	% completed	For GS: Display only field for the percentage of the time for which the point has been occupied based on the setting for Stop measurement based on in the GS Quality Control panel. Appears in the page during the point occupation if Automatically stop point measurement is checked.
	Annotation 1 to Annotation 4	Editable field for comments to be stored with the point.
	Antenna height	For GS: Editable field for antenna height for static observations.
	Attribute (free) 01 to Attribute (free) 20	Display only field for attributes for free codes.
	Attribute 01 to Attribute 20	Editable field for attributes for codes.
	Azimuth	For TS: Display only field for the azimuth.
	Code	Editable field for codes.
	Code (free)	Editable field for free codes.
	Code description (free)	Display only field for the description of free codes.
	Code description	Display only field for the description of codes.
	Easting	For TS: Display only field for Easting coordinate of measured point.
	GDOP	For GS: Display only field for the current GDOP of the computed position.
	HDOP	For GS: Display only field for the current HDOP of the computed position.
	Height	For TS: Display only field for the height coordinate of the measured point.
	Difference in height	For TS: Display only field for the height difference between setup and reflector.
	Horizontal distance	For TS: Display only field for horizontal distance.

Field	Option	Description
	Humidity	For GS: Editable field for relative humidity to be stored with point.
	Hz angle	For TS: Display only field for the horizontal angle.
	Local ellipsoid height	For GS: Display only field for the elevation of the current GNSS position.
	Moving antenna height	For GS: Editable field for antenna height for moving observations.
	Logged raw data counter	For GS: Display only field for the number of static observations recorded over the period of point occupation. Appears in the page when recording of static observations is configured.
	Northing	For TS: Display only field for Northing coordinate of measured point.
	Offset height	For TS: Editable field for height offset for measured point.
	Offset in/out	For TS: Editable field for horizontal distance offset, in the direction of line of sight.
	Offset left/right	For TS: Editable field for horizontal distance offset for measured point, perpendicular to the line of sight.
	Offset mode	For TS: Select offset mode.
	PDOP	For GS: Display only field for the current PDOP of the computed position.
	PPM total	For TS: Display only field for the total ppm value.
	Point ID	Editable field for the point ID.
	Pressure	For GS: Editable field for atmospheric pressure.
	Prism constant	For TS: Display only field for additive constant of currently selected reflector.
	1D quality	Display only field for the current height coordinate quality of computed position.
	2D quality	Display only field for the current 2D coordinate quality of computed position.
	3D quality	Display only field for the current 3D coordinate quality of computed position.

Field	Option	Description
	RTK positions	For GS: Display only field for the number of positions recorded over the period of point occupation. Appears in the page of real-time rover settings.
	Slope distance (last stored)	For TS: Display only field for the last recorded distance.
	Separator	Insert half line space.
	Slope distance	For TS: Display only field for measured slope distance.
	Standard deviation	For TS: Display only field of standard deviation in millimetres of averaged distances.
	Target height	For TS: Editable field for prism height.
	Unused line	Insert full line space.
	Temperature (dry)	For GS: Editable field for dry temperature to be stored with point.
	Temperature (wet)	For GS: Editable field for wet temperature to be stored with point.
	Time at point	For GS: Display only field for the time from when the point is occupied until point occupation is stopped. Appears in the page during the point occupation.
	V angle	For TS: Display or select vertical angle.
	VDOP	For GS: Display only field for the current VDOP of the computed position.
	WGS84 ellipsoid height	For GS: Display only field for the current GNSS position.
	WGS84 latitude	For GS: Display only field for the current GNSS position.
	WGS84 longitude	For GS: Display only field for the current GNSS position.

26.3

ID templates

26.3.1

Accessing ID Template Configuration

Description

ID templates are predefined templates for point IDs. ID templates save having to type in the ID for each point. They are useful when many points are collected quickly, for example in post-processed and real-time kinematic operations. The ID templates that are selected to be used suggest IDs for **Point ID**, **Auto point ID** and auxiliary points when points are measured.

Access

Select **Leica Captivate - Home: Settings\Customisation\ID templates**.

ID Template Library

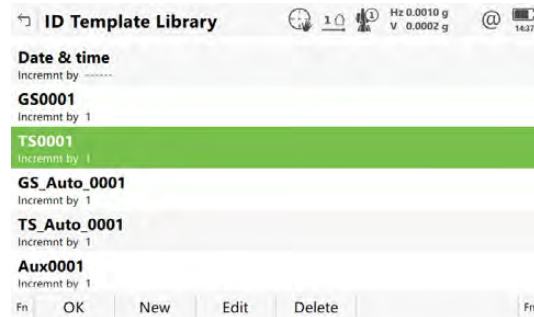

Key	Description
OK	To select the highlighted template.
New	To create an ID template.
Edit	To edit the highlighted ID template.
Delete	To delete the highlighted ID template. It does not matter if the ID template is being used in a working style. The ID template is rebuilt when that working style becomes active.
Fn Default	To recall deleted default ID templates.

Description of metadata

Metadata	Description
-	The name of the ID template and the format of the ID object.
Increment by	The amount by which the point ID is incremented.

Default ID templates

Some ID templates are implemented by default.

Default ID template	Description
<Manually enter>	The last point ID during a survey is displayed. This ID is automatically incremented if it contains numerical characters. If this ID is overwritten, the auto increment starts from the new ID. The automatic incrementation can be turned off when editing this ID template.

Default ID template	Description
Date & time	Last four digits of the serial number of the instrument plus current local time and date is the ID.
Aux0001	Suggested as ID for auxiliary points in default working styles. These points are used when trying to find a stakeout point. This ID is automatically incremented.
GPS0001	Suggested as ID for GS measured points in default working styles. This ID is automatically incremented.
GPS_Auto_0001	Suggested as ID for GS auto points in default working styles. These points are automatically recorded at a specific rate. This ID is automatically incremented.
TPS0001	Suggested as ID for TS measured points in default working styles. This ID is automatically incremented.
TPS_Auto_0001	Suggested as ID for TS auto points in default working styles. These points are automatically recorded at a specific rate. This ID is automatically incremented.

26.3.2

Creating/Editing an ID Template

Access

In **ID Template Library**, highlight an ID template. A copy of this ID template is taken for further settings. **New**.

New ID Template/ Edit ID Template

Key	Description
OK	To store the new ID template into the ID template library.

Description of fields

Field	Option	Description
ID	Editable field	The name of the ID template and the format of the ID object. Any characters including spaces are allowed. Leading spaces are not accepted.
Increment point ID	Selectable list	IDs are incremented numerically or alphanumerically.

Field	Option	Description
Increment by	Editable field	The amount by which the point ID is incremented.
When point ID is edited, place cursor in position number	Selectable list	The character position at which the cursor is placed when ENTER is pressed in Point ID or Line ID when surveying points. Last Character means that the cursor is placed immediately to the right of the last character.

Examples for incrementation

For Increment point ID: Only numerically

The rightmost numeric part is incremented within the point ID.

ID	Increment by	Next point ID	Notes
Point994	5	Point999 Point1004 ...	-
994point	5	999point 1004point ...	-
123point123	-10	123point113	Numbers on the right are incremented. Negative increments allowed.
Point11	-6	Point5 Point-1 Point-7 Point-13 ...	-
Abcdefghijklmn94	5	Abcdef- ghijklmno99 Point ID increment fail	Incrementation fails if next increment will result in more than 16 characters.
Abcdefghijklmno9	-5	Abcdefghijklm- nop4 Point ID increment fail	Negative incrementing fails if next increment requires negative sign and will result in more than 16 characters.

For Increment point ID: Alphanumerically

The rightmost character within the point ID is incremented regardless of whether that character is numeric or alphanumeric.

ID	Increment by	Next point ID	Notes
Point994	5	Point999 Point99E Point99J ...	-
994point	5	994poiny Point ID incre- ment fail	Lower case alpha characters incre- ment until z is reached. Then a new point ID must be entered.
Abcdef	-5	Abcdea AbcdeV ... AbcdeB Point ID incre- ment fail	Lower case alpha characters decre- ment from lower to upper case until A is reached. Then a new point ID must be entered.
ABCDEB	5	ABCDEG ABCDEL ... Abcdez Point ID incre- ment fail	Upper case alpha characters incre- ment from upper to lower case until z is reached. Then a new point ID must be entered.

26.4

Hot keys & favourites

Description

The settings on this panel assign functions or panels to each of the first and second level of hot keys, including the **F13**, the key on the side of the instrument, and the favourites key.

Access

Select **Leica Captivate - Home: Settings\Customisation\Hot keys & favourites**.

Hot Keys & Favourites, GS Hot Keys/TS Hot Keys page

To configure the first level of hot keys.

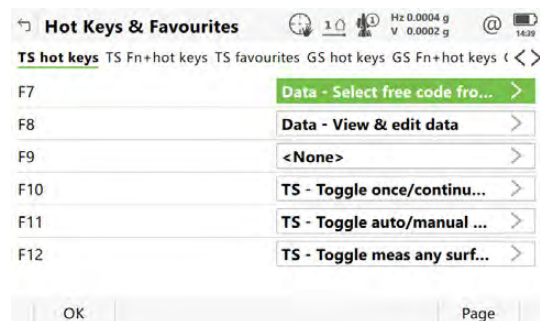

Key	Description
OK	To accept changes and return to Leica Captivate - Home .

Key	Description
Page	To change to another page on this panel.

Description of fields

Field	Option	Description
F7 to F12	Selectable list	All functions or panels which can be assigned to the particular key.
Key on side of instrument	Selectable list	Available for MS60/TS60. All functions or panels which can be assigned to the key on the side of the instrument.

Next step

Page changes to the **GS Fn+hot keys/TS Fn+hot keys** page.

Hot Keys & Favourites,
GS Fn+hot keys/TS Fn+hot keys page

To configure the second level of hot keys.

The functionality on this page is identical to the one on the **GS Hot Keys/TS Hot Keys** page.

Next step

Page changes to the **GS favourites/TS favourites** page.

Hot Keys & Favourites,
GS favourites/TS favourites page

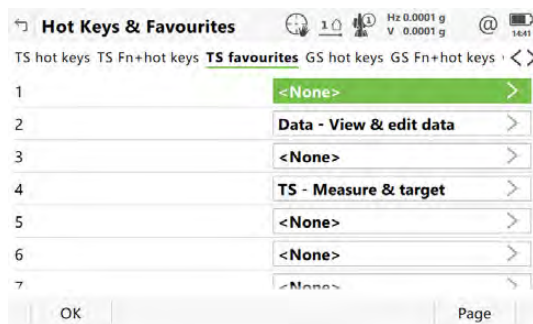

Key	Description
OK	To accept changes and return to Leica Captivate - Home .
Page	To change to another page on this panel.

Description of fields

Field	Option	Description
1 to 9	Selectable list	All functions or panels which can be assigned to the individual buttons in the user-defined bubble.

26.5

Coding

Description

The settings on this panel define the method of coding. Refer to "27 Coding" for a complete description of coding.

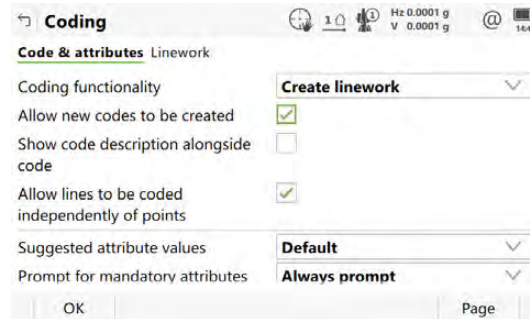

**Coding,
Code & attributes
page**



Key	Description
OK	To accept changes and return to Leica Captivate - Home.
Page	To change to another page on this panel.

Description of fields

Field	Option	Description
Coding functionality	Create line-work	A quick way for a code to be selected and a point to be measured. Stringing and linework can be done at the same time. In the apps, a non-customisable page is displayed. The page consists of: <ul style="list-style-type: none"> • An editable field for a code • One box per code. The boxes show the code name including metadata. Symbols indicate the type of linework and if attributes are assigned to the code.
	Only code pts (no line-work)	Codes are selected from a list or can be typed in manually.
Allow new codes to be created	Check box	When this box is checked, the field for code selection is a selectable list and an editable field at the same time. Enter text to create a code or to search in the list for already available codes. Open the list to display the codes in the codelist including their metadata. When this box is not checked and Coding functionality: Create linework , the field for codes appears on an extra page and is a simple list. When this box is not checked and Coding functionality: Only code pts (no line-work) , the codes are listed in a simple list without metadata.
Search for codes when typing	Check box	Available for Coding functionality: Only code pts (no linework) and Allow new codes to be created being checked.

Field	Option	Description
		<p>When this box is checked, existing codes starting with the same letters are suggested when typing into the Code field. By pressing OK, the code is selected.</p> <p>To stop the search and to accept the current text as the new code do one of the following:</p> <ul style="list-style-type: none"> Click the icon on the screen:  Press ESC on the hardware:  <p>When this box is not checked, existing codes are still suggested but not highlighted. By pressing OK, the typed letters will create a new code instead of using an existing.</p>
Show code description alongside code	Check box	When this box is checked, then the description of a code is shown in brackets next to the code in a code box. Example: TREE (Tree description).
Allow lines to be coded independently of points	Check box	<p>Available for Coding functionality: Create linework.</p> <p>When this box is checked, codes with attributes can be assigned to lines. The code assignment is done in the edit line panel which is displayed each time a new string is created.</p> <p>Depending on the needs and later workflows, codes and attribute values must be linked to lines or points.</p> <p>Example for coding a line of trees by coding the line: Measure two trees in the line as points and code them by a point code "Tree" with attribute "Height". Create linework between both tree points. Assign the line code "Tree" with the attribute "Tree type" to the line. The information regarding the tree type is linked to the line geometry.</p> <p>Example for coding a line of trees by coding the points: Measure two trees in the line as points and code them by a point code "Tree" with attribute "Tree type". Both points define the line of trees. The information regarding the tree type is linked to the points.</p>
Suggested attribute values		Determines the attribute values displayed under certain circumstances. This setting is applicable to both the storing and displaying of attribute values.
	Default	When available, the default attribute values, as stored in the job, are displayed and stored.

Field	Option	Description
	Last used	When available, the last used attribute values as stored in the job are displayed and stored.
Prompt for mandatory attributes	Always prompt	A panel to enter mandatory attributes always appears when codes being stored have one or more attributes of attribute type mandatory. Attributes of attribute type mandatory or fixed can only be created in Infinity.
	Only if no value	A panel to enter mandatory attributes only appears when codes being stored have one or more attributes of attribute type mandatory, without an attribute value. Attributes of attribute type mandatory must always be created in Infinity.
	When code is changed	A panel to type in mandatory attributes only appears when a new code with a mandatory attribute was selected.

Next step

For **Coding functionality: Create linework**, **Page** changes to the **Linework** page.

For **Coding functionality: Only code pts (no linework)**, **Page** changes to the **Quickcoding** page.

Coding, Linework page

The flags for Linework are defined on this screen. A flag

- is stored as a property of a point.
- can be exported with a format file.
- is different to a code.

The flags defined on this screen are linked to the options available for **Linework** in an app. The selection for **Linework** determines the flag stored with a point. Refer to "27.2 Coding functionality: Create linework" for information on Linework.

Description of fields

Field	Option	Description
Begin line	Editable field	Opens a new line when the next point is stored. Any lines which are currently open are closed. The point can be stored with a point code.
Begin 3 pt arc	Editable field	Stores the linework flag for a curve through the next three measured points and continues a line.
Continue line	Editable field	Indicates a line is open.
Begin spline	Editable field	Stores the linework flag for beginning either a spline or a best fit arc and continues any open line.

Field	Option	Description
End spline	Editable field	Stores the linework flag to stop a spline or a best fit arc.
Cont spline	Editable field	Indicates a line is open with spline line or best fit arc types.
Close line	Editable field	Closes all open lines.

Coding,
Quickcoding page

Description of fields

Field	Option	Description
Quick-coding	Never	Prevents the use of quick coding completely.
	On	Allows the use of quick coding and activates it.
	Off	Allows the use of quick coding, but keeps it deactivated.
Digits to use	1, 2 or 3	Sets the mostly used number of digits for the quick code. Quick codes with fewer digits can still be used. While typing a quick code during a survey, using ENTER after typing one or two digits of the quick code indicates the end of the input.
Store free code	After point is stored or Before pt is stored	Determines if a free code measured with a quick code is stored before or after the point.

26.6

App visibility

Access

Select **Leica Captivate - Home: Settings\Customisation\App visibility**.

App Visibility

Click the icon if you want to hide or display an app in the **Leica Captivate - Home** panel.

The order of apps in this list defines the order of apps in the **Leica Captivate - Home** panel.



Use **Up** and **Down** to move an app to another position.

Description

A code is a description which can be stored by itself or with a point.
The ability to plot the measured lines in real-time is an added value to coding.

Code types

Code Types	Characteristic	Description
Point code	Use	To store a description together with an object inside an app or in View & edit data from the job menu. By a setting, stringing of points can be activated. The generated point is strung to the previous one with the same code and string number. A string number is automatically appended to the generated line.  It is possible to ignore the stringing temporarily. The assigned linework operation must be set <None> .
	Selection	On a configured page, codes are selected from a list or entered into an editable field.
	Recording	Together with the objects.
Free code	Use	To store a description independent of an object at any time. A free code can be used to store a description related to an object, or extra descriptions such as the job name or temperature.
	Selection	<ul style="list-style-type: none"> For free coding using a codelist: Pressing the configured hot key opens a selectable list with the free codes of the job codelist. The job codelist must contain free codes. For free coding with direct input: Pressing the configured hot key opens a panel for alphanumeric input.
	Recording	Stored as time-related information. A time stamp is stored with each free code. Free codes selected using quickcoding can be configured to be stored before or after the object.
Quick code	Use	Quick coding is the storing of an object plus a point or free code using a minimum number of keystrokes.

Code Types	Characteristic	Description
	Selection	Shortcuts must be assigned to codes in the job codelist. Quickcoding: On must be set in Coding, Quickcoding page. Typing the shortcut searches for the assigned code. Point measurement begins.
	Recording	<ul style="list-style-type: none"> For point codes: Together with the objects. With Automatically stop point measurement and Automatically store point both checked in GS Quality Control, the points and codes are immediately stored. For free codes: Stored as time-related information before or after the points. A time stamp is stored with each free code.
		Quick codes must be created in Infinity.
		Characters that can be assigned to quick codes are: <ul style="list-style-type: none"> 0 to 9 A to Z a to z

Code types and code modes

Feature	Coding functionality	
	Create line-work	Only code pts (no linework)
Point coding	✓	✓
Automatic stringing	✓	-
Free coding	✓	✓
Quick coding	-	✓
Page customisable with simple fields	-	✓
Page fixed to code field and code boxes	✓	-

Hierarchy of code modes

Hierarchy	Description
1.	Quick coding, if configured and used
2.	String number from highlighted code box with a stringable point code
3.	Numeric input in code field

Configure coding

Refer to "26.5 Coding" for information on configuring coding.

27.2

Coding functionality: Create linework

27.2.1

Point Coding and Stringing

Requirements

- **Coding functionality: Create linework** is selected in **Coding**.
- The user-defined page for codes must be configured.

Fields and icons

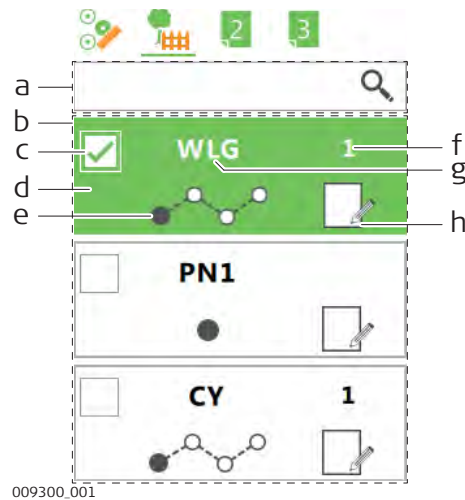

- a Code input field
- b Code box list
- c Multicode check box
- d Code box
- e Linework operation
- f String number
- g Code and, if available, code description in brackets
- h Attributes

Code input field

Part	Key combination	Description
	-	Code input field The code input field is a dynamic list-box. The working principle is: Click into the listbox. Type in the first characters of the code. If the code exists in the codelist, the listbox populates dynamically and drops down. Codes fitting to the input are loaded from the job codelist.
	Fn Clear one	To remove the highlighted code box from the list.
	Fn Clear all	To remove all code boxes from the list.







Code box



A code box combines within itself a code with metadata of string, linework operation and attributes.

The used codes are shown in the code box list. The code box for the latest code is at the beginning of the list. Use the up and down arrow key to select a code from the code box list.

For the Measure, Measure to line, Stake road and Check rail apps, the current list of up to eight code boxes can be stored to a template and reloaded. Refer to "37 Apps - The Toolbox".

The metadata of a code box is editable. Tap on specified parts of a code box. Or use the key combinations listed in the table.

Part in code box	Key combination	Description
	Multi on	Multicoding To measure one point but store it multi-times. The stored points have different point IDs and codes but the same coordinates. The number of selected codes defines the number of stored points. Up to eight codes are selectable.
	Multi on + Tap into check box	Multicoding is enabled and selected
	Multi off	Multicoding is disabled
	Define Code	Code
	Define String+ or type in a number	Stringing Surveyed points with the same code and stringing metadata are strung together on one line. The stringing metadata is linked to the line ID. The stringing icon is visible when linework is defined to be created. To increase the number of strings by one.
	Define String- or type in a number	To decrease the number of strings by one.

Part in code box	Key combination		Description
	Define	Linework	<p>Linework</p> <p>The stringing icon is visible when linework is defined to be created. The type of linework icon shows the outstanding linework operation. Refer to "Select Linework" for information on the linework icons and their meaning.</p> <p>Change the selected geometry with a configured hot key or favourites menu when a code box is highlighted.</p>
	Define	Attributes	<p>Attributes</p> <p>The use of attributes allows additional information to be stored with the code.</p>
			<p>Additional information has been edited and stored with the code.</p>

Selecting a code

Using the code input field

1. Click into the listbox.
2. Type the first characters of the code into the code input field.
3. Select the code from the drop-down list.

Using the code box

1. Tap on the left bottom part of the code box for a code.
2. The measured point is stored with the selected code and the metadata displayed in the code box.

Using the code box list

1. Use the up and down arrow key to highlight a code in the code box list.
2. The measured point is stored with the selected code and the metadata displayed in the code box.

Using the code box list

1. Highlight a code in the code box list.
2. Press **Define** and then **Code**.
3. Select a code from the list.
4. Press **OK**.

Creating a code

Using the code input field

1. Click into the code input field.

2. Type the new code name into the code input field.
3. Press **OK** on the keyboard.
4. The new code box for the new code is added at the beginning of the code box list.



Using the code box

1. Tap on a code in the code box list.
2. Press **New**.
3. Type in a code name and select the metadata. Refer to "8.4.2 Creating/Editing a Code".
-  To add attributes, press **New attrib.**
4. Press **Store**.

Using the code box list



1. Highlight a code in the code box list.
2. Press **Define** and then **Code**.
3. Press **New**.
4. Type in a code name and select the metadata. Refer to "8.4.2 Creating/Editing a Code".
-  To add attributes, press **New attrib.**
5. Press **OK**.





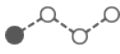

Editing code attributes

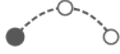
1. Tap on a code in the code box list.
2. Press **Define** and then **Attributes**.
3. Change the code attributes.
4. Press **OK**.
-  If the user defined page  is configured such that attribute fields are displayed, then the attributes can also be entered on that page.

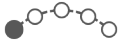
Select Linework

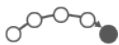
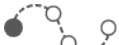
Description of icons

Icon	Description
	<None>
	Begin line Opens a new line with a new string number. Starts from the current point.
	Continue line Continues the line/arc assigned to the current line and string.
	Begin 3 pt arc Starts a new arc. The next three points form the arc. If there is a line with the current code and string already open, the arc is appended to it. The arc is displayed in 3D viewer when all three points are measured.

Icon	Description
	<p>Begin best fit arc Starts a new curve. A smoothing mathematical function is used to best fit the subsequent points. The curve starts with the first measured position. If there is a line with the current code and string already open, the best fit curve is appended to it. The best fit curve is a single radius curve. A compound curve is not supported. The best fit curve is displayed in 3D viewer when a point was measured with End best fit arc.</p>
	<p>Continue best fit arc Adds a new point to the sequence of points that define the shape of the best fit curve.</p>
	<p>End best fit arc Calculates the best fit curve of single radius. Start point is a previous point of the same line with Begin best fit arc. All points measured between Begin best fit arc and End best fit arc are included in the curve. The best fit curve is displayed in 3D viewer. Once the best fit curve is ended, it continues the line.</p>
	<p>Begin spline Starts a new spline passing by the subsequent points. The spline starts with the first measured position. If there is a line with the current code and string already open, the spline is appended to it. The spline is a multiple radius curve. A compound curve is not supported. The spline is displayed in 3D viewer when a point was measured with End spline.</p>
	<p>Cont spline Adds a new point to the sequence of points that define the shape of the spline.</p>
	<p>End spline Calculates the spline. Start point is a previous point of the same line with Begin best fit arc. All points measured between Begin spline and End spline are included in the curve. The spline is displayed in 3D viewer. Once the spline is ended, it continues the line.</p>
	<p>Close line Continues the line at the current measured point. Closes the line by joining it to the first point of the line. The first point of the line is added to the bottom of the list as closing point.</p>

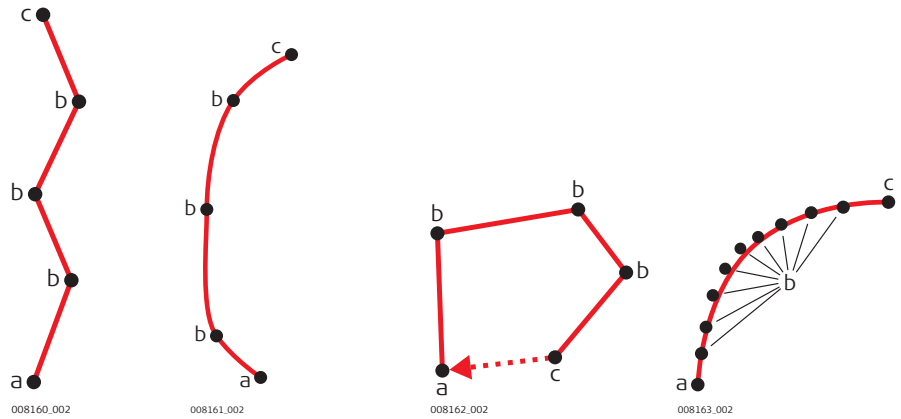

a **Begin line**
 b **Continue line**
 c **End line**

a **Begin spline**
 b **Continue line**
 c **End spline**

a **Begin line**
 b **Continue line**
 c **Close line**

a **Begin best fit arc**
 b **Continue line**
 c **End best fit arc**

27.3

Coding functionality: Only code pts (no linework)

27.3.1

Point Coding with Dynamic List

Requirements

- **Coding functionality: Only code pts (no linework)** is selected in **Coding**.
- **Allow new codes to be created** is checked in **Coding**.
- The user-defined page with a field for codes must be configured.

Coding

1. Click in the field **Code** or **Code (auto)** in a user-defined page in an app.

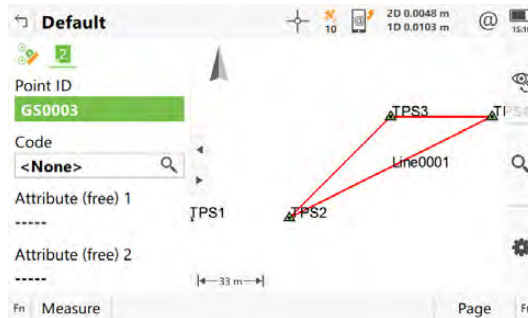

2. Type in a point code or select a code from the list.
3. Type in attribute if defined.
4. Press **Measure**.

27.3.2

Point Coding without Dynamic List

Requirements

- **Coding functionality: Only code pts (no linework)** is selected in **Coding**.
- **Allow new codes to be created** is not checked in **Coding**.
- The user-defined page with a field for codes must be configured.

Coding

1. Click in the field **Code** or **Code (auto)** in a user-defined page in an app.

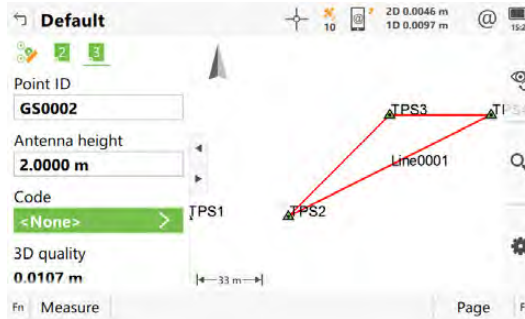

2. Select a code from the list.
3. Type in attribute if defined.
4. Press **Measure**.

Select Code

Codes from the job codelist, which belong to an active code group, are available for selection.

Codes are listed with the code description, the code group, the code type and the quick code if codes with quick codes exist in the job.

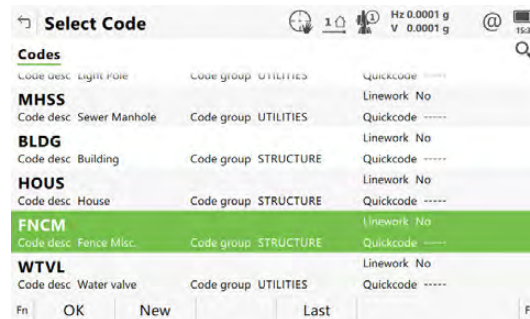

Key	Description
OK	To accept changes and to return to the panel from where this panel was accessed.
New	To create a code.
Attributes	Available unless creating/editing a point/line. To type in attribute values for the selected code and/or add new attributes for the selected code.
Last	Available if a code has been previously used in the job. To select from a list of last used codes. The codes are sorted by time with the most recently used code at the top of the list.
Fn Group	To view, create, delete, activate and deactivate code groups. Refer to "8.5 Managing Code Groups".
Fn Sort	To sort codes by code name, code description, quick code, in the order they were added to the codelist, or the last used.

Next step

Highlight the desired code.

Press **OK** to return to the Measure panel.
 Or press **Attributes** to access **Enter Attributes**.

Enter Attributes

If configured for the selected code, editable fields for attribute values are available. Any preconfigured attribute rules, for example, integer numbers only, a set range, or a selectable list, control what values can be entered.

Tap in the field of the attribute name or attribute value.

Edit the name of the attribute.

Type in a default attribute value.

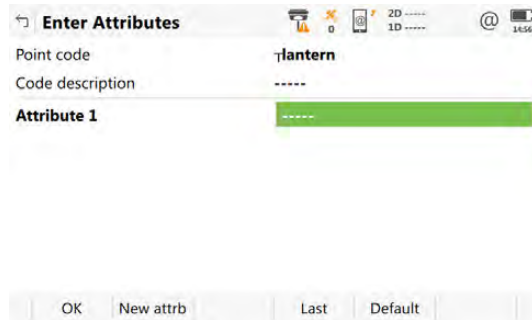

Key	Description
OK	To return to the panel from where this panel was accessed.
New attrb	To add an attribute of type normal and of value type text. Up to twenty attributes can be added. Attributes of type mandatory or fixed and of value type real or integer must be created in Infinity.
Last	To recall the last used attribute values for the selected code.
Default	To recall the default attribute values for the selected code.

Next step

Press **OK**. The code and any associated attribute values are stored when the point is stored. If a point with the same point ID exists in the job, the codes, attribute names and attribute values of the new and existing points must be identical. Should they not be identical, a panel opens where the code or attribute mismatch can be corrected.

27.3.3

Quick Coding

Requirements

- The job codelist contains quick codes.
- According to the user requirements, set **Store free code: Before pt is stored** or **Store free code: After point is stored** in **Coding, Quickcoding**.

Activate quick coding

- For **Quickcoding: On**, quick coding is active and can be used.
- For **Quickcoding: Off**, use a hot key or the favourites menu.
- For **Quickcoding: Never**, change the setting manually.

Performing quick coding

A panel must be active where points can be measured.

Type in the one, two or three digits of the quick code. The current setting for **Digits to use** in **Coding, Quickcoding** page determines by how many keystrokes quick coding is executed.

Press **ENTER** to execute quick coding after less than the configured keystrokes. This action is possible after one keystroke for **Digits to use: 2** and one or two keystrokes for **Digits to use: 3**.

Press **ESC** to clear digits from the entry.

Only mandatory attribute values can be entered. For non-mandatory attributes, either the default or the last used attribute values are stored, depending on the setting for **Suggested attribute values** in **Coding, Code & attributes** page.

For point codes:

- The point code assigned to the quick code is searched for in the job codelist and point measurement begins.
- The point code and any associated attribute values are stored with the point.
- If a point with the same point ID exists in the job, the codes, attribute names and attribute values of the new and existing points must be identical. Should they not be identical, a panel opens where the code or attribute mismatch can be corrected.

For free codes:

- The free code assigned to the quick code is searched for in the job codelist and point measurement begins.
- The free code, associated attribute values and time-related information are stored. The setting for **Store free code** in **Coding, Quickcoding** page determines if the free code is stored before or after the point.

27.4

Free Coding

27.4.1

Free Coding Using a Codelist

Requirements

- The job codelist contains free codes.
- A hot key is configured to access the panel **Free Code & Attributes** or the favourites menu is configured to display the option **Data - Select free code from list**.

Access

Press a hot key configured to access the panel **Free Code & Attributes**. Refer to "2.2.1 Hot Keys" for information on hot keys.

Select Free Code

All free codes from the job codelist which belong to an active code group, are available for selection.

Codes are listed with the code description, the code group, the code type and the quick code if codes with quick codes exist in the job.

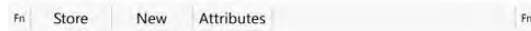
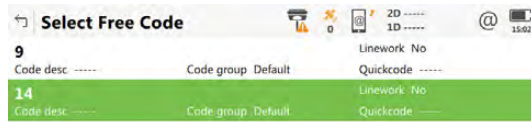

Key	Description
Store	To store the free code and any associated attribute values and to return to the panel from where this panel was accessed.
New	To create a code.
Attributes	To type in attribute values and/or add new attributes for the selected free code. Refer to "27.3.2 Point Coding without Dynamic List".
Last	Available if a free code has been previously used in the job. To select from a list of last used free codes. The free codes are sorted by time with the most recently used code at the top of the list.
Fn Group	To view, create, delete, activate and deactivate code groups. Refer to "8.5 Managing Code Groups".
Fn Sort	To sort codes by code name, code description, quick code or the last used.

27.4.2 Free Coding with Direct Input

Requirements A hot key is configured to access the panel **Free Code & Attributes** or the favourites menu is configured to display the option **Data - Enter free code**.

Access Press a hot key configured to access the panel **Free Code & Attributes**. Refer to "26.4 Hot keys & favourites" for information on hot keys.

Free Code & Attributes Type in a code and attribute values. As soon as a free code is typed in, a codelist is created within the job. Up to eight attributes can be added. Refer to "27.4.1 Free Coding Using a Codelist" for a description of keys.

Next step
Press **Store**.

27.5 Code and Attribute Mismatch

27.5.1 Code Mismatch

Description When storing a point with a code, it can happen that a point with the same point ID exists in the job. If the codes of the new and the existing point do not

match, a panel opens where the code can be corrected. One point cannot have different codes.

Point Code Mismatch

This panel opens automatically if the codes of the new and the existing point do not match. Highlight the code to be stored with the new point.

Key	Description
Store	To store the highlighted code and any associated attributes with the point being stored and to continue with the app or data management.
More	To display information about the code description, the code group and any attributes associated with the highlighted code.

Description of fields

Field	Option	Description
New Code	Display only	The code for the point.
Stored Code	Display only	The code as stored for the existing point in the job.

27.5.2

Attribute Mismatch

Description

If a point with the same point ID exists in the job, the codes, attribute names and attribute values of the new and existing points must be identical. Should the attributes not be identical, a panel opens where the attribute mismatch can be corrected. One point cannot have different attribute information.



The name of the panel changes with pressing **Current** or **Stored**:

Pressing **Current**: **Attributes Being Stored**
 Pressing **Stored**: **Attributes Already Stored**

Attributes Already Stored

This panel opens automatically if the attribute names and/or values of the new and the existing point do not match.

Attributes Already Stored	
Point ID	GS0001
Point code	fance
Code description	leftfanceline
colour	black
material	metal
height	-----

Store Current Fn

Key	Description
Store	To store the selected attributes with the new/created point and to continue with the app or data management.
Current or Stored	To change between viewing the attribute names and values of the new/created point and those values stored for the existing point in the job.

Description of fields

Field	Option	Description
Point code	Display only	<ul style="list-style-type: none"> For Attributes Already Stored: The code of the existing point in the job. For Attributes Being Stored: The code of the new point.
Attributes	Display only	<ul style="list-style-type: none"> For Attributes Already Stored: The attributes as stored for the existing point in the job. For Attributes Being Stored: The attributes of the new point.

Description

The settings on this panel define the behaviour of the instrument for a general startup.

Access

Select **Leica Captivate - Home: Settings\System\Software startup**.

Software Startup, Startup behaviour page

If a check box is checked, the corresponding panel is shown during startup. If all check boxes are unchecked, then, after turning on the instrument, the **Leica Captivate - Home** is accessed immediately.

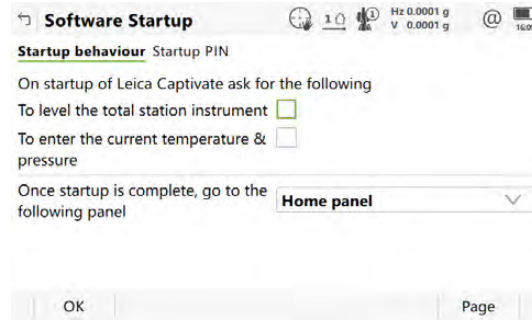

Key	Description
OK	To accept changes and return to Leica Captivate - Home .
Page	To change to another page on this panel.

Next step

Page changes to the **Startup PIN** page.

Software Startup, Startup PIN page

If **Activate PIN lock: Yes**, then, after turning on the instrument, a PIN code must be entered.

Description of fields

Field	Option	Description
Activate PIN lock	Check box	When this box is checked, then PIN protection is activated and a PIN code must be entered at startup. When this box is not checked, PIN protection is not activated and no PIN code is required at startup.
Enter PIN to be used	Editable field	Available if Activate PIN lock is checked. The new PIN code that is required at startup. PIN codes must be numerical only and 4 to 6 digits in length.

Description

The settings on this panel allow the screen appearance to be configured, turn the notification beeps on and off and define the behaviour of the keys. The

settings are stored on the field controller itself. If the field controller is exchanged, the settings stored on the new field controller apply.

Access

Select **Leica Captivate - Home: Settings\System\Screen, audio & text input**.

Screen, Audio & Text Input, Screen page

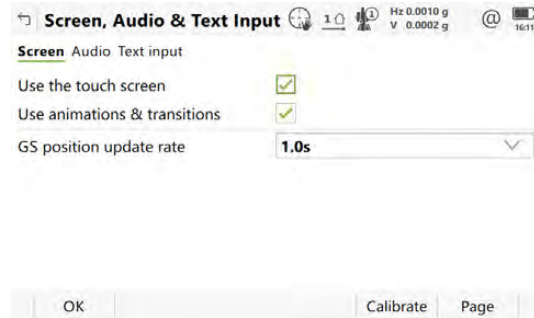

Key	Description
OK	To accept changes and return to Leica Captivate - Home .
Calibrate	To calibrate the touch screen.
Page	To change to another page on this panel.

Description of fields



Field	Option	Description
Use the touch screen	Check box	If checked, the touch screen is turned on.
Use animations & transitions	Check box	When this box is checked, all animations and transitions are active.

When this box not is checked, the majority of animations and transitions are inactive, especially panel to panel animations.

Some animations remain always active:

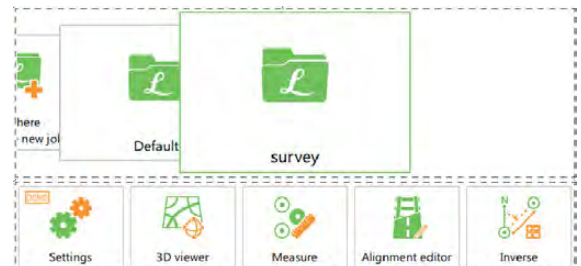
- All animations of the job carousel and the apps carousel in **Leica Captivate - Home**

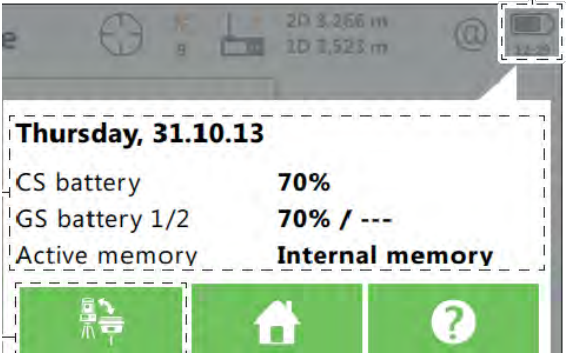

Field	Option	Description
		<ul style="list-style-type: none"> The job spin when a job is tapped 
		<ul style="list-style-type: none"> The icon pop-up bubbles when an icon is tapped 
		<ul style="list-style-type: none"> The sliding of the underline when pages are selected 
		<p>Animations are a method of drawing attention to the user that a change has happened inside Leica Captivate. This change could be caused by the user himself or may be automatically generated by Leica Captivate to notify the user that something has changed.</p> <p>Transitions are a method designed to notify the user that the panel being displayed in the Leica Captivate software is changing. These visual aids are useful as Leica Captivate has many similar looking panels. Transitions allow the user to navigate through the software more easily.</p>
		<p> The setting is stored as part of the system and always remembered even after restarting the instrument.</p>
GS position update rate	0.2s, 0.5s, or 1.0s	The panel update rate for the GNSS positions.

Next step

Page changes to the **Audio** page.

Screen, Audio & Text Input, Audio page

Description of fields

Field	Option	Description
For messages, play	Sounds only	A sound alert is given when an information message appears.
	Sounds & voice	A sound and voice alert is given when an information message appears.
Beep when total station turns past 0, 90, 180 or 270°	Check box	If checked, the horizontal sector beep is turned on. The instrument beeps when within 5 gon/4°30' of the defined sector, has a long and consistent beep within 0.5 gon/27' and no beep within 0.005 gon/16''.
Hz sector angle	Editable field	Editable field for the sector angle for which a beep sounds.

Next step

Page changes to the **Text input** page.

Screen, Audio & Text Input, Text input page

Description of fields

Field	Option	Description
Data input method	None, Function keys, Mobile phone style or Pop-up keyboard	Alphanumeric input can either be through function, numeric keys or through a pop-up keyboard to be used with the stylus.
Default characters	Selectable list	Sets the set of extra characters available through Data input method: Function keys or F1-F6 whenever an entry is made. The choices available depend on the character sets loaded on the instrument and the language configured to be used.

28.3

Regional

Description

The settings on this panel define

- the units for all types of measurement data displayed.
- information related to some types of measurement data.
- the order in which coordinates are displayed.
- the instrument identification number.
- the languages available on the instrument.

Access

Select **Leica Captivate - Home: Settings\System\Regional**.

Regional, Distance page

Key	Description
OK	To accept changes and return to Leica Captivate - Home .
Page	To change to another page on this panel.

Description of fields

Field	Option	Description
Distance	Metre (m)	Metres [m]
	International ft (fi)	International feet [fi], storage in US feet
	Intl ft/inch (fi)	International feet [fi], inches and 1/8 inches (0' 00 0/8 fi), storage in US feet
	US ft (ft)	US feet [ft]
	US ft/inch (ft)	US feet, inches and 1/8 inches (0' 00 0/8 fi) [ft]
	Kilometre (km)	Kilometres [km]
	US mile (mi)	US miles [mi]
Distance decimal	From 0 to 4	The number of decimal places shown for all distance and coordinate related fields. This setting is for data display and does not apply to data export or storage. The available options depend on the selected Distance .
Chainage format	+123456.789	Selects display format for all chainage information fields. Default chainage display form.
	+123+456.789	Separator between hundreds and thousands.
	+1234+56.789	Separators between tens and hundreds.
	+123.4+56.789	Separator between tens and hundreds with extra decimal point.
	PegN°+10.000	In this format, a peg distance is used to calculate a peg number and to determine which value is shown next to it.

Field	Option	Description
		For example, at chainage of 100 m and a peg distance of 20 m, the peg number equals 5 ($100/20 = 5$). Chainage 100 m = 5 + 0.000 Chainage 110 m = 5 + 10.000 Chainage -100 m = -5 - 0.000 Chainage -90 m = -4 - 10.000
Area	m², Intl acres (Ai), US acres (A), Hectares (ha), fi² or ft²	The units shown for all area-related fields.
Volume	m³, fi³, ft³ or yd³	The units shown for all volume-related fields.

Next step

Page changes to the **Slope** page.

Regional, Slope page

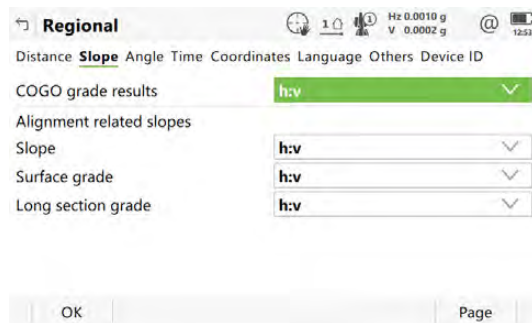

Key	Description
OK	To accept changes and return to Leica Captivate - Home .
Page	To change to another page on this panel.

Description of fields

Field	Option	Description
All fields	h:v	Horizontal by vertical distance.
	v:h	Vertical by horizontal distance.
	%(v/h x 100)	Percentage of vertical by horizontal distance.
	Elevation angle	Elevation angle.

Next step

Page changes to the **Angle** page.

Description of fields

Field	Option	Description
Angle	400 gon, 360 ^o mil, 360° dec or 6400 mil	The units shown for all angular and coordinate related fields.
Angle decimal	From 1 to 4 From 2 to 4 5 0.1", 1", 5", 10" or 60"	The number of decimal places shown for all angular and coordinate related fields. This setting is for data display and does not apply to data export or storage. Available for Angle: 6400 mil . Available for Angle: 400 gon and Angle: 360° dec . Available for MS60/TS60 and Angle: 400 gon or Angle: 360° dec . Unavailable for remote applications. Available for Angle: 360^omil .
Hz angle display	North azimuth, South azimuth, North anti-clockwise Bearing	Sets the reference direction as well as the direction from where and how azimuths are computed. The azimuth fields in other panels are called Azimuth . The azimuth fields in panels are called Bearing . NE, SW, SE and NW indicate the quadrant of the bearing.

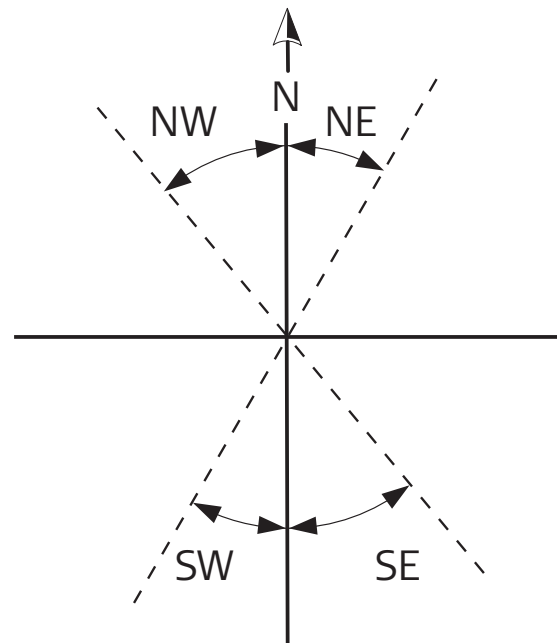

GS_049

Field	Option	Description
	Angle right	Displays the horizontal angle difference between the backsight point and the current telescope position. The azimuth fields in panels are called Angle right .
		<p>GS_128</p> <p>P0 Instrument setup P1 Backsight point P2 Point in direction of current telescope position α Azimuth β Angle right</p>
V angle display		For TS.
	Zenith angle	$V = 0$ in zenith.
	Elevation angle	$V = 0$ horizontal elevation angle. Vertical angles are positive above the horizon and negative below it.
	Elevation angle %	$V = 0$ horizontal. Vertical angles are expressed in % and are positive above the horizon and negative below it.
Use direction to	True north or Magnetic north	Sets the North direction.
Declination	Editable field	Available for Use direction to: Magnetic north . The value for the magnetic declination. It is considered when computing or using any azimuth values.
Hold V angle after a distance measurement	Check box	For TS. If checked, the vertical angle is fixed after a distance measurement with Distance , whereas the horizontal angle is continuously updated with the telescope movement.

Field	Option	Description
		If not checked, the vertical angle is continuously updated with the telescope movement.
		 The active prism height is applied in the calculation of remote point elevations. The prism height must be set to zero to display and record the elevation of the targeted remote point.

Next step

Page changes to the **Time** page.

Regional, Time page

The time zone is read from WinEC.

Description of fields

Field	Option	Description
Time format	24 hour or 12 hour (am/pm)	How the time is shown in all time-related fields.
Current time	Display only	Shows an example of the selected time format.
Date format	Day.month.year, Month/day/year or Year/month/day	How the date is shown in all date-related fields.
Current date	Display only	Shows an example of the selected date format.



Next step

Page changes to the **Coordinates** page.

Regional, Coordinates page

Description of fields

Field	Option	Description
Grid format	Easting, northing or Northing, easting	The order in which grid coordinates are shown in all panels. The order in Measure panels depends on the user settings.
Geodetic format	Latitude, longitude or Longitude, latitude	The order in which geodetic coordinates are shown in all panels. The order in Measure panels depends on the user settings.

Field	Option	Description
Switch Easting for CAD files and Switch Northing for CAD files	Check box	When these boxes are checked, then the signs of the Easting and Northing coordinates of CAD files are changed so that the CAD file in the 3D viewer is mirrored. The setting applies to all apps, including Roads.
		 The signs of the Easting/Northing coordinate only change for the display purposes. The signs are not changed in the database.
		 When importing/exporting dxf data, the signs of the data are switched according to the setting.

Next step

Page changes to the **Language** page.

Regional, Language page

The languages available on the instrument. Three languages can be stored on the instrument at one time - English and two others. English cannot be deleted.

The selected language is used for the system software. If a language is not available for the system software, the English language is used instead.

Apps are available in the languages that were loaded on the instrument when the app was installed.

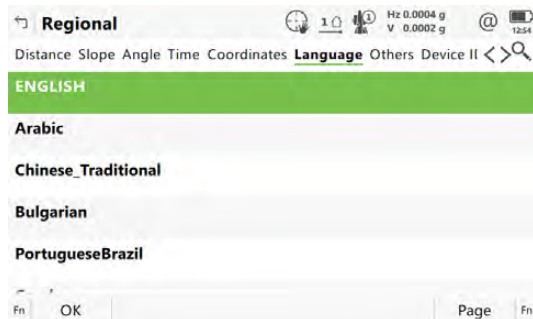

Key	Description
OK	To accept changes and return to Leica Captivate - Home .
Delete	To delete the highlighted language.
Page	To change to another page on this panel.

Next step

Page changes to the **Others** page.

Description of fields

Field	Option	Description
Temperature	Celsius (°C) or Fahrenheit (°F)	The units shown for all temperature-related fields.
Pressure	mbar, mmHg, Inch Hg (inHg), hPa or psi	The units shown for all pressure-related fields. PSI = pounds per square inch.
Velocity unit	Km/h (kph), Mph (mph) or Knots (kn)	The units shown for all velocity-related fields.
Switch WLAN driver	Check box	When this box is checked, an alternative WLAN configuration is loaded. Changing the WLAN configuration can improve the connection between a CS20 and a mobile hot spot. The setting is stored within the working style.  Restart the CS20 after changing the setting. During the restart, the WLAN driver and registry key settings are applied.

Next step

Page changes to the **Device ID** page.

Description of fields

Field	Option	Description
Device ID	Editable field	This number is used for the generation of the file names. Using format files, the instrument ID can be exported together with data from the instrument. By doing so, it can be identified which instrument was used for certain measurements. Sets a four-digit number as instrument identification number. By default the last four numbers of the serial number are used.

28.4

Restrict access

Description

By the settings on this panel, access to certain areas of the system can be locked for other users, for example restricting them from creating a new working style.

To unlock the system, a correct password must be entered. The number of attempts of password entries is not limited.

Access

Select **Leica Captivate - Home: Settings\System\Restrict access.**

IF the system is	THEN
locked	the password must be typed in.
not locked	restriction settings can be set and a password can be defined. Refer to "Access Restriction Wizard,What do you want to do?".

**Access Restriction Wizard,
What do you want to do?**

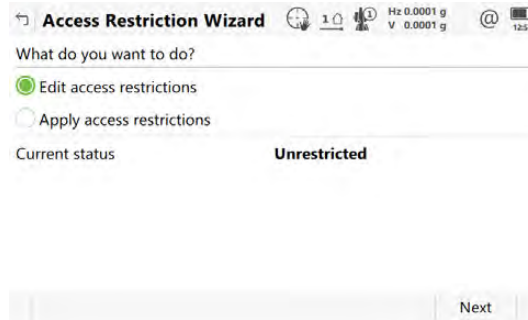

Key	Description
Next	To accept changes and to continue with the subsequent panel within the wizard.

Next step

IF you want to	THEN
edit lock settings	select Edit access restrictions , press Next and follow the instructions on the panel. Then continue with "Access Restriction Wizard,Select the settings to be available.".
lock settings	select Apply access restrictions , press Next and continue with "Access Restriction Wizard,Enter new admin password.".

**Access Restriction Wizard,
Enter new admin password.**

Description of fields

Field	Option	Description
Password	Editable field	Type in the password.
Display password	Check box	When this box is checked, the password is displayed in the Password field. When this box is not checked, dots are displayed in the Password field

Next step

Next and then **Finish** saves the password and changes the state of the system to **Restricted**.

Access Restriction Wizard,

Key	Description
Back	To return to the previous panel.

Select the settings to be available.

Key	Description
Edit	To open the panel corresponding to the highlighted field. Shows the panel that is hidden or displayed.
Next	To accept changes and to continue with the subsequent panel within the wizard.

Access Restriction Wizard, Do you want to apply user restrictions?

Key	Description
Back	To return to the previous panel.
Next	When Yes, apply user restrictions now is checked and this key is pressed, a password can be typed in. When No, just finish the wizard is checked, this key returns to the Leica Captivate - Home .

28.5

Calibration of Internal Sensors

Availability

Available for CS20. **Calibrate Disto tilt sensor** is available if the CS20 is equipped with a DISTO.

Access

Select **Leica Captivate - Home: Settings\System\Calibrate internal sensors** or **Calibrate Disto tilt sensor**.

Sensor Calibration

Calibrate the internal sensors prior to use when the compass functionality is used. The calibration wizard guides through the calibration process.

Disto Tilt Calibration

Re-calibrate the DISTO tilt sensor if the CS20 has been dropped or heavily bumped.

The calibration wizard guides through the calibration process.

Steps to check if a re-calibration is required:

1. Place the CS20 on a flat surface about 20 m away from a wall but aiming at the wall.
2. Access a panel where it is possible to view the tilt value: Select **Leica Captivate - Home: Measure**. Press **Fn Tools**. Select **Measure hidden point**.
3. The tilt value must be close to 0.
4. If the tilt differs from 0, then the DISTO calibrate the tilt sensor.

Description

This chapter describes the basic procedure for

- transferring objects between the data storage device and the internal memory.
- sending a job from the field controller to the TS and vice versa. The TS menu cannot be used when it is connected to the field controller. The commands for sending the jobs from and to the TS must be operated from the field controller only.

Refer to "B Directory Structure of the Memory Device" for information about file types and locations of files on the data storage device.

Access

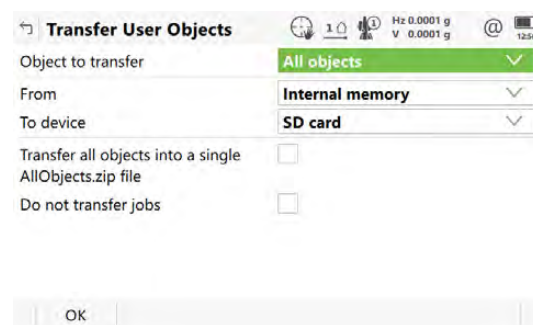

Select **Leica Captivate - Home: Settings\Tools\Transfer user objects**.





Transfer User Objects

Key	Description
OK	To transfer an object and return to the panel from where this panel was accessed. For transfer between TS and field controller, the job is transferred through Bluetooth, radio or cable. For transfer between TS and field controller with jobs larger than 1 MB: <ul style="list-style-type: none"> • The transfer time is estimated and displayed. Press Yes to start the transfer or No to cancel. • A progress bar indicates the progress of the transfer.

Description of fields

Field	Option	Description
Object to transfer	Selectable list	Listed are the objects that can be transferred. The available fields on the panel depend on the option selected.
From	SD card	Data storage device to transfer object from. Transfer from the Secure Digital Memory card. Unavailable for CS35.

Field	Option	Description
	USB	Transfer from the USB.  The CS35 has two USB ports. The USB stick, that was inserted first, is used.
	Internal memory	Transfer from the internal memory.
To device	Selectable list	Data storage device to transfer object to. Data storage device not selected in From .
Job	Selectable list	To select the job to be transferred.
Antenna	Selectable list	To select the antenna records to be transferred.
Codelist	Selectable list	To select the codelist to be transferred.
Coordinate system	Selectable list	To select the coordinate system to be transferred.
CSCS field file	Selectable list	To select the Country Specific Coordinate System to be transferred.
DTM	Selectable list	To select the DTM job to be transferred.
File	Display only or selectable list	The dial-up list, the device list, the RTK profiles list and the server list to be transferred as binary file. To select the user-defined templates stored on the data storage device in CONFIG \SKETCH_TEMPLATES.
Format file	Selectable list	To select the format files to be transferred.
Geoid field file	Selectable list	To select the Geoid Field File to be transferred.
Rail design	Selectable list	To select the Rail job to be transferred. Available when the Stake rail/Check rail app is loaded.
Road design	Selectable list	To select the Road job to be transferred. Available when the Stake road/Check road app is loaded.
Tunnel design	Selectable list	To select the Tunnel job to be transferred. Available when the Stake tunnel/Check tunnel app is loaded.
Working Style	Selectable list	To select the working style to be transferred.  Working styles cannot be transferred between Leica SmartWorx Viva and Leica Captivate or vice versa.
XSL Style-sheet	Selectable list	To select the style sheets to be transferred.



Field	Option	Description
Import image	Selectable list	<p>To select the geo-referenced map background image to be transferred.</p> <p> When selecting a world file image, the *.jpg and *.jgw files must have the same file names.</p> <p> The converted image file has the same name as the original .jpg file.</p>
Transfer all objects of the selected type	Check box	Available for some transfer object options. To transfer all objects.
Transfer all objects into a single AllObjects.zip file	Check box	<p>Available for Object to transfer: All objects. To zip all objects automatically during transfer.</p> <p> User-defined templates for the sketch pad are included.</p> <p> *.jpg and *.jgw files from the \Data and from the \Data \Map_Images folder are excluded. *.archive files from the \Data \Map_Images folder are transferred.</p> <p> When Do not transfer jobs is checked, jobs will be excluded from the zip file.</p>
Transfer scans, Transfer images, Transfer surfaces, Transfer CAD files and Transfer XML files	Check box	<p>Available on CS when connected to TS. Available for Object to transfer: Job. Select the objects to transfer between CS and TS. Reduce the selection to shorten the transfer time.</p>
Do not transfer jobs	Check box	Available for Object to transfer: All objects . To exclude jobs from the transfer.
Transfer linked jobs	Check box	Available for Object to transfer: Job with Transfer all objects of the selected type not checked. To transfer the selected job including the linked jobs. The transfer is possible between memory devices on one instrument. The link between the job and the linked jobs is updated with the path of the new memory device.

Access



Select **Leica Captivate - Home: Settings\Tools\Update software.**

Update Software

For CS20 and TS

-  Uploads are possible from the SD card. Store the file to upload in the \SYSTEM directory of the SD card. The upload file has the extension *.fw.
-  Alternatively use myWorld to upload files.

For CS35

-  Uploads are possible from the USB stick or the internal memory. Store the setup.exe in the \SYSTEM directory.
-  On the CS35, online uploads from myWorld are not supported.

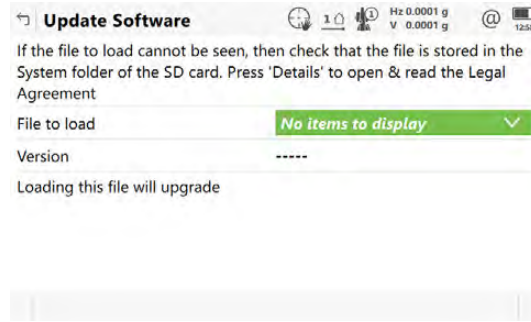

Key	Description
OK	To upload the update and return to the panel from where this panel was accessed. Available when I have read and agree to the Leica Geosystems Legal Agreement is checked.
Details	To display the license agreement.
Delete	To delete an app.

Description of fields

Field	Option	Description
File to load	Selectable list	List of files stored in the \SYSTEM directory of the SD card (CS20/TS) or USB stick/internal memory (CS35). Listed are files which are compatible with the expected file name and extension for the instrument in use. Firmware, apps, languages and WinCE are packed in one file per instrument. For CS20 Full variants, the file includes also the internal modem firmware.

Field	Option	Description
		Separate upload files are available for: <ul style="list-style-type: none"> • Special apps • Software for peripheral devices. Peripheral devices are: RTK radio expansion pack, Novatel GNSS ME, Cinterion 3.5 modem module
		 The expiry date of the software maintenance contract must be the same or after the release date of the upload package. If the expiry date of the software maintenance contract is older, then any licensed Leica Captivate functionality cannot be used. Licence keys can still be loaded. Third-party software on the instrument can be used but not controlled remotely.
Version	Display only	Version of the selected firmware/app file.
Loading this file will upgrade	Check box	The upgradable elements contained in the selected File to load . Check elements you want to upload.
I have read and agree to the Leica Geosystems Legal Agreement	Check box	Press Details to read the license agreement. Then check this box in order to allow installing any firmware, apps or languages.



It is not possible to have more than three language files stored on the instrument. English is always available as the default language and cannot be deleted.



There is only one version of each app. The app is installed in English and in any other language that is already loaded onto the instrument. If a new language is loaded after an app has been installed, the app will need to be reinstalled to become available in the new language.

29.3

Load licence keys

Description

A licence key can be used to activate apps and protected options and can be used to define the expiry date of the software maintenance. Refer to "30 Settings -About Leica Captivate" to find out how to check the expiry date of the software maintenance.

For CS20 and TS

To upload a licence key file, the file must be on the \SYSTEM directory of the data storage device. Licence key files use the naming convention L_123456.key, where 123456 is the instrument serial number.

For CS35

The equivalent to license keys on the CS35 is the entitlement ID. To activate the entitlement ID use the CLM wizard for Leica Captivate or the CLM for Node-locked licenses. In all cases, an internet connection is required.

Access

Select **Leica Captivate - Home: Settings\Tools\Load licence keys.**

Load Licence Keys

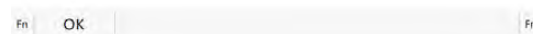

Key	Description
OK	To accept changes and return to Leica Captivate - Home or continue with the app.
Fn Delete	To delete all licence keys on the field controller.

Description of fields

Field	Option	Description
Load licence file from	Selectable list	The licence key file is uploaded from the data storage device. The licence key file must be stored in the \SYSTEM directory on the data storage device.

29.4

Format memory

Description

Allows the data storage device and the internal memory to be formatted. All data is erased.



If the internal memory is formatted, all system data such as almanac, user-defined configuration sets, user-defined antennas, codelists, geoid field files and CSCS field files will be lost.

Access

Select **Leica Captivate - Home: Settings\Tools\Format memory.**

Format Data Memory

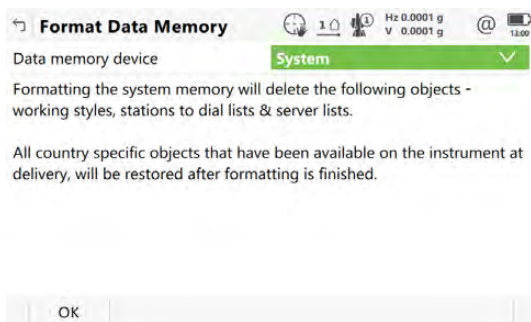

Key	Description
OK	To format a data storage device and return to the panel from where this panel was accessed.

Description of fields

Field	Option	Description
Data memory device		The type of memory to be formatted.
	Internal memory	Formatting the Internal memory will delete the following objects currently stored on the internal memory - jobs, admin settings, codelists, coordinate systems, format files, geoid & CPCS field files, RTK profiles, sketch templates & user entered antennas. All country specific objects (codelists, coordinate systems..) that have been available on the instrument at delivery, will be restored after formatting is finished.
	SD card	Formatting the SD card will delete all data currently stored on the SD card.
	USB stick	Formatting the USB stick will delete all data currently stored on the USB stick.  The CS35 has two USB ports. The USB stick, that was inserted first, is used.
	Apps	Formatting the Apps will delete all currently loaded apps.
	System	Formatting the system memory will delete the following objects - working styles, stations to dial lists & server lists. All country specific objects that have been available on the instrument at delivery, will be restored after formatting is finished.

29.5

Calculator

Access

Select **Leica Captivate - Home: Settings\Tools\Calculator**.

Description

The calculator can be used to perform the following arithmetic operations:

Operation	Description
+	To add two values.
-	To subtract two values.
*	To multiply two values.
/	To divide two values.
+ -	To change between positive and negative algebraic sign for a value.
=	To display the result.
x^2	To calculate x^2 .
x^y	To calculate x^y .
sqrt	To calculate $\sqrt{\quad}$ of a value.
PI	To recall the value 3.1415926536.
sin	To calculate sine of a value.
asin	To calculate arcsine of a value.
cos	To calculate cosine of a value.
acos	To calculate arccosine of a value.
tan	To calculate tangent of a value.
atan	To calculate arctangent of a value.
C	To clear the display.
< -	To delete the last digit in the display.
MS	To save a value into memory.
MSR	To recall a value in memory.
done	To quit the calculator.

29.6

FTP data transfer

Description

This functionality is to transfer jobs, codelists and other files on the data storage device with a standard and simple FTP server.

FTP protocol is used to transfer between an instrument, which has an Internet device connected, and the FTP server. The zip/unzip functionality is included.

Supported files

The following list shows the supported file extensions that will automatically move to the corresponding directory after downloading.

Supported file	File extension	Directory
Almanac file	Almanac.sys	DATA/GPS
Antenna file	List.ant	GPS
App files	*.a*	SYSTEM
ASCII files for import/export to/from job	*.txt	DATA
Coordinate system file	Trfset.dat	DBX
CSCS field files	*.csc	DATA/GPS/ CSCS

Supported file	File extension	Directory
DXF files for import/export to/from job	*.dxf	DATA
Firmware files	*.fw	SYSTEM
Format files	*.frt	CONVERT
Geoid field files	*.gem	DATA/GPS/ GEOID
GSI files	*.gsi	GSI
GSM/Modem station list	*.fil	GPS
Language files	*.s*	SYSTEM
Licence file	*.key	SYSTEM
Report sheets created from apps	*.log	DATA
TS working style files	*.xfg	CONFIG
System files	System.ram	SYSTEM
Custom ASCII file (Leica Captivate Export)	*.cst	DATA
Comma-separated variables, text file format (ASCII)	*.csv	DATA



Configure and connect the Internet interface before using this function.

Access

Select **Leica Captivate - Home: Settings\Tools\FTP data transfer**.

FTP Data Transfer

FTP Data Transfer

Enter the FTP connection details.

Host: ftp.leica-geosystems.com

TCP/IP port: 21

User ID: S1200

Password: ●●●●●●

Display password:

Connect

Key	Description
Connect	To connect to the FTP server entered.

Description of fields

Field	Option	Description
Host	Editable field	In order to get access to the Internet, a host name is required. This host name identifies the instrument in the Internet.
TCP/IP port	Editable field	Port to be used. Any number between 0 and 65535 is valid.
User ID	Editable field	The User ID allows connection to the FTP site. If no value is typed in, then the instrument logs in to the FTP server anonymously.

Field	Option	Description
Password	Editable field	The password to get access to the FTP site.
Display password	Check box	When this box is checked, the password is displayed in the Password field. When this box is not checked, dots are displayed in the Password field

Next step

Connect. Once the connection to the FTP server is established, the **FTP Data Transfer, Internal** page is displayed.

FTP Data Transfer, Internal page

The files and folders on the selected data storage device of the instrument are displayed including their size. To get into the folders, highlight the folder and **ENTER**.

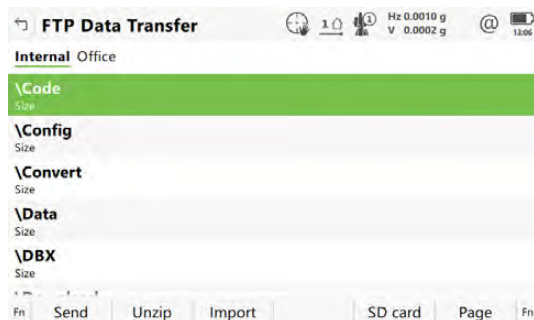

Key	Description
Send	To copy the file or folder to its corresponding directory on the FTP server. Files or folders bigger than 100 KB are zipped before sending.
Unzip	To unzip a file in the download directory. Available if a zip file is highlighted.
Import	To move a file from the \Download folder to the appropriate directory folder based on its file extension type. Available in the \Download folder when a file is highlighted. Unavailable for unrecognised files in the \Download folder. These files must stay in the \Download folder.
SD card, USB or Internal	To change between the data storage devices and the internal memory.  The CS35 has two USB ports. The USB stick, that was inserted first, is used.

Next step

Page changes to the **Office** page.

FTP Data Transfer, Office page

The files located on the FTP server are displayed.

Whenever switching to this page, if the connection to the server was disconnected, then a refresh action is done or it reconnects to the server.

The most important keys are explained.

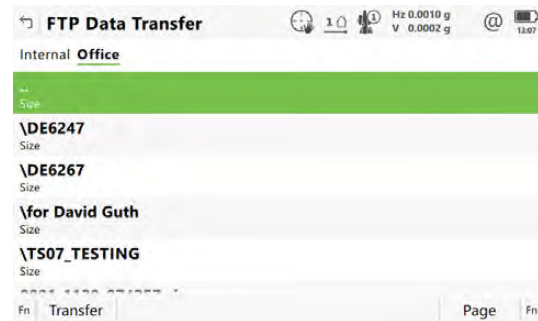

Key	Description
Transfer	To download the highlighted file or folder list on the FTP server to the local download folder. If recognised by the system, downloaded files are moved automatically to the corresponding directories. If not, they are stored in the download folder. Zipped files are unzipped before storing in the download folder.
Page	To change to another page on this panel.
Fn Refresh	To refresh the FTP directory.

29.7

Leica Exchange

29.7.1

Overview

Description

Leica Exchange is an online service that allows the data exchange between two users of the service. For example:

- The user in the field sends the daily measured data to the user in the office.
- The user in the field sends a codelist to a second user in the field.

Requirements

- Valid Leica Exchange subscription
- Leica Exchange licence key loaded on a field controller/instrument

AND / OR

- Leica Exchange entitlement ID loaded on a computer with Leica Exchange Office

Creating User name and Password step-by-step

1. Order a Leica Exchange subscription. You will receive a subscription form.
2. Take the subscription ID in the subscription form and log in to your myWorld account (<https://myworld.leica-geosystems.com>).
3. Navigate to myTrustedServices.
4. On the **My Trusted Services** tab, select **Add Service** and type in the subscription ID.

5. The Leica Exchange Service is shown in the **My Trusted Services** tab. Once the Leica Exchange Service is registered, users can be assigned to the service on the **My Users** tab.

6. Click the **Add** button to define a new user and to assign services to the user.
For each user:

- Enter contact information
- Define a unique user name
- Assign a password

The user name and password are needed each time you access the Leica Exchange Service. The Leica Exchange Service can be accessed from Leica Captivate in the field or using Leica Exchange Office PC software.



After registering the subscription ID in your myWorld account, the subscription usage statistic is fully accessible. The total quota is shown and the consumed and remaining GB are displayed in total GB and GB/month.

Access

Select **Leica Captivate - Home: Settings\Tools\Leica Exchange**.

If a user is logged in then the **Leica Exchange** menu is accessed. If no user is logged in then the **Leica Exchange Login** panel is accessed.

Leica Exchange Login

User name and password must be typed in each time the **Leica Exchange** service is accessed.

Description of fields

Field	Option	Description
User name	Editable field	The user ID created in MyWorld allows connection to the exchange server.
Password	Editable field	The password created in MyWorld to get access to the exchange server.
Display password	Check box	When this box is checked, the password is displayed in the Password field. When this box is not checked, dots are displayed in the Password field

Next step

The first time you log in to **Leica Exchange** you need to accept the license agreement.

If a connection to the **Leica Exchange** server is active and if the user name and password are recognised, then **OK** accesses **Leica Exchange** menu.

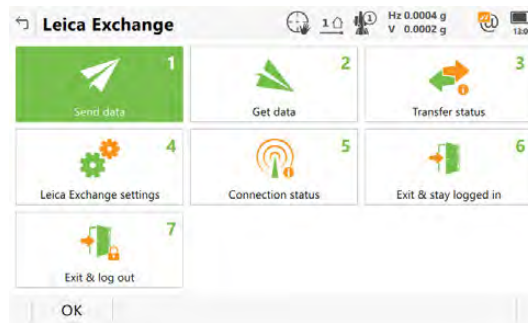

Key	Description
OK	To access the selected functionality.

Description of options

Icon	Description
Send data	To select objects to be uploaded to the server from the CS or TS and to start the upload. Access Select Data to Send .
Get data	To select objects to be downloaded from the server to the CS or TS and to start the download. Access Select Data to Download . Data sent to a user are stored in the users "inbox" for two weeks.
Transfer status	To check the transfer status for the last 20 transfers since log in.
Leica Exchange settings	To access the Settings panel.
Connection status	To see details about the connection. A checked box indicates an established connection to the Leica Exchange Server.
Exit & stay logged in	To remain logged in but return to the Leica Captivate - Home . Any transfer in progress continues in the background. You can see from anywhere inside Leica Captivate when new files are received.
Exit & log out	To log out and to return to the Leica Captivate - Home . Any transfer in progress is stopped.

29.7.2

Configuring Leica Exchange

Access

Select **Leica Exchange settings** in **Leica Exchange** menu.

Settings, General page

This panel consists of two pages. The explanations for the softkeys given here are valid for all pages.

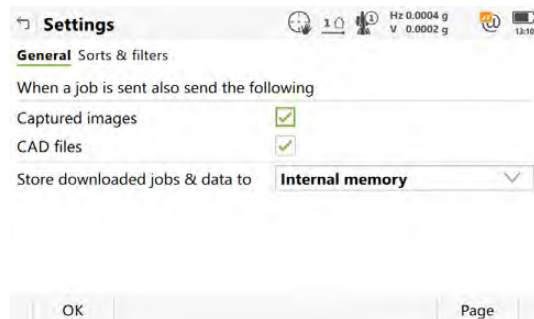

Key	Description
OK	To accept changes and return to the panel from where this panel was accessed.
Page	To change to another page on this panel.

Description of fields

Field	Option	Description
Captured images	Check box	When this box is checked, the jobs are sent with the Images folder.
CAD files	Check box	When this box is checked, the jobs are sent with the Map files folder.
Store downloaded jobs & data to	Selectable list	The device on which the jobs and data are stored.
		Jobs and data are stored in the internal memory when the chosen data storage device is not available.

Next step

Page changes to the **Sorts & filters** page.

Settings, Sorts & filters page

Description of fields

Field	Option	Description
Display objects sorted by		The method points are sorted by.
	Source	Sorts the objects by the instrument they were measured with.
	Size	Sorts the objects by size in Kb.
	File name	Sorts the objects alphabetically by the object name.

Field	Option	Description
	Type	Sorts the objects in alphabetical order of the object types. After applying the alphabetical order, the time is considered for the order of the files.
Display the following objects for sending or receiving files	Check boxes	When a box is checked, the filter is active for that object type. The filter is valid for objects sent from the instrument. Objects on the server are always visible.

Next step

OK closes the panel.

29.7.3

Sending Data

Access

Select **Send data** in **Leica Exchange** menu.

Select Data to Send

Ticked objects are used for sending data.
Unticked objects are not used for sending data.

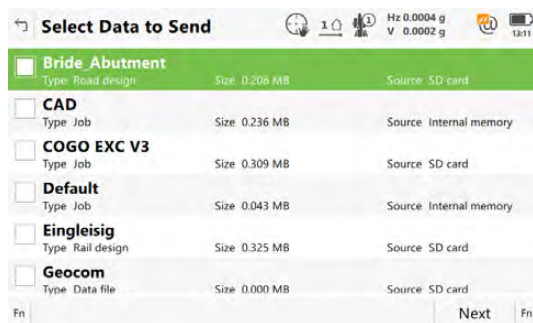

Key	Description
Next	To confirm the settings and continue to the next panel. The Internet and server connection is checked.
Fn All or Fn None	To select or deselect all object for sending data.
Fn Filter	To sort and filter the objects listed.

Description of metadata

Metadata	Description
-	The user-defined name of the objects.
Type	Supported are job, CAD files (dxf and shape files), data files, coordinate systems and codelists.
Source	The data storage device where the object is stored.
Size	The size of the selected object.

Next step

Make a selection and press **Next**.

Select People to Send Data

Listed are the user names of people data can be sent to. The list is downloaded from MyWorld. Refer to "Creating **User name** and **Password** step-by-step" for information on how to define user names.

Tick the user names to send data to. Multiple selection is possible.

Key	Description
Back	To return to the previous panel.
Next	To confirm the settings and to continue to the next panel.
Fn All or Fn None	To select or deselect all users for sending data.

Next step

Make a selection and press **Next**. The transfer starts.

While the transfer is in progress,

- the status can be checked by pressing **Status**. Refer to "29.7.5 Data Transfer Status".
- Other tasks can be done. Press **Finish** to exit the wizard.

29.7.4

Getting Data

Access

Select **Get data** in **Leica Exchange** menu.

Select Data to Download

The information shown is derived from the list of information retrieved from the server.

Ticked objects are used for getting data.

Unticked objects are not used for getting data.

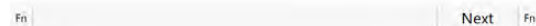

Key	Description
Next	To confirm the settings and to continue to the next panel. The Internet and server connection is checked.
Fn All or Fn None	To select or deselect all object for sending data.
Fn Filter	To sort and filter the objects listed.

Description of metadata

Metadata	Description
-	The user-defined name of the objects.
Source	The user the data comes from.
Type	Supported are job, CAD files (dxf and shape files), data files, coordinate systems and codelists. Jobs downloaded from the server are stored in a subfolder of the DBX folder of the data storage device selected in Store downloaded jobs & data to in Settings, General page. All files with unknown format, for example CAD or data files, are stored in the \DATA folder of the selected data storage device. Coordinate systems and codelists are stored to the internal memory of the CS or TS. From the internal memory, the codelist/coordinate system can be directly selected when creating/editing a job.
Size	The size of the selected object.

Next step

Make a selection and press **Next**. The transfer starts.

While the transfer is in progress,

- the status can be checked by pressing **Status**. Refer to "29.7.5 Data Transfer Status".
- Other tasks can be done. Press **Finish** to exit the wizard.

29.7.5

Data Transfer Status

Access

Select **Transfer status** in **Leica Exchange** menu.

Data Transfer Status

The last 20 transfers since log in are displayed.

Key	Description
OK	To return to Leica Exchange menu.
Pause	To pause all transfers.
Resume	To restart all transfers.
Accept	Available when a row with status Conflict is highlighted. To choose between replacing or discarding the downloaded file.
Remove	Available for finished or cancelled transfers. To remove the transfer from the list.
Cancel	To cancel the highlighted transfer.
More	To change between user, size, date and expected time by when the transfer is finished.

Description of metadata

Metadata	Option	Description
-	-	The type of file transferred.

Metadata	Option	Description
Name	-	The name of the file transferred.
Who	-	The user the file is transferred to or from.
Status	-	... down/up - The downloading/uploading transfer is in progress.
	Sent	The upload has been successfully finished.
	Downloaded	The download has been successfully finished.
	Pending	A transfer is in progress and the current transfer has not been started.
	Paused	The transfer has been paused.
	Cancelled	The transfer has been cancelled.
	Conflict	The transfer is finished, but there is another file with the same name in the designated folder. Press Accept .
	Interrup.	The transfer has been interrupted due to internet connection loss or other events that result in interrupting the transfer.
Size	-	The size of the selected object.
Time left	-	The estimated time until the transfer is finished.

29.7.6

In the Office

In the office

1. After activating the Entitlement ID, login to Leica Exchange Office with your user name and password.
2. Click on one of the icons to define the view in the right half of the window: **Inbox**, **Status**, **History**, **Contacts**. On the left side of the window, the data on the computer are displayed. Navigate to the folder you want to place received data or to where the data to be sent are stored.
3. To get files from the inbox, click **Inbox**, select the files and drag them into the left half of the window.
To send data, click **Contacts** and drag & drop the files from the left to the right. To send files to multiple users, select the users, drag & drop the files from the left to the right.
4. To see the status of current transfers, click **Status**.
To see all transfers done from both field and office and also the time when the objects were sent and received, click **History**.

Access

Select **Leica Captivate - Home: Settings>About Leica Captivate**.

**About Leica Captivate,
CS controller page**

The information relates to the field controller. This panel shows, depending on the controller type:

- The serial number,
- The equipment number,
- The firmware version of the boot software,
- The firmware version for the **Electric Front Interface**,
- If a total station radio is installed,
- If Wireless LAN is installed,
- If the internal GSM/CS modem is installed.

Next step

Page changes to the **Total station** page.

**About Leica Captivate,
Total station page**

The information relates to the TS instrument. This panel shows:

- The type of instrument,
- Extra instrument hardware options such as EDM or PowerSearch.

Next step

Page changes to the **GS sensor** page.

**About Leica Captivate,
GS sensor page**

The information relates to the GS instrument. This panel shows:

- The type of instrument,
- The serial and equipment numbers,
- The software version,
- The information about the **Measurement Engine** and tracking capability,
- The availability of instrument hardware options,
- The maintenance date (CCP end date, **Customer Care Package**),
- The availability of instrument software options

Next step



Page changes to the **Leica Captivate** page.

**About Leica Captivate,
Leica Captivate page**

This panel shows the apps installed on the instrument, and the following information.

Description of fields

Field	Description
WinEC version	Firmware version for WinCE.

Field	Description
Leica Captivate version	Firmware version for the onboard software. An information is displayed, when a new Leica Captivate version is available in myWorld. For an automatic check, the instrument must be connected to the Internet. For the installation of the new firmware, the Customer Care Package installed must be valid.
API version	Firmware version for the app interface.
CCP end date	<p>Expiry date of the software maintenance (Customer Care Package).</p> <p>When the TS or CS is switched on, a reminder message appears within one month of the due date of the software maintenance or when the software maintenance has expired.</p> <p> The message appears only once!  is displayed on the Leica Captivate - Home until the licence key has been updated.</p> <p>Refer to "29.3 Load licence keys" for updating licence keys.</p>
mySecurity end date	If mySecurity is activated in myWorld: The date when the instrument must be connected to mySecurity in order to renew the security functionality. If mySecurity is not activated in myWorld: Not activated is displayed.
Status of app related licence keys	The information listed here indicates for which apps the licence keys are loaded.

Next step

Page changes to another page on this panel.

31

Instrument Protection (Theft Protection)

31.1

Anti-Theft Alarm

Description

Available on TS and CS in remote mode.

The anti-theft alarm can support a protection against instrument theft while on the working site. The alarm goes off if the instrument is unlevelled for more than 3s. The sound is played in highest volume.

1. Set up and level the instrument.
2. Configure a hot key or favourites to activate/deactivate the anti-theft alarm. Refer to "2.2 Configurable Keys" for information.
3. Use a hot key to activate the alarm.
4. Perform the survey on the site.
5. When the survey is finished, use a hot key to deactivate the alarm.

 The anti-theft alarm functionality must be licenced.

31.2

mySecurity

Description

mySecurity is a cloud-based theft protection. A locking mechanism ensures that the instrument is disabled and can no longer be used. A Leica Geosystems service centre will inform local authorities if such an instrument turns up.

mySecurity is activated in myWorld.

Adding/removing instruments to/from mySecurity

1. Go to myWorld@Leica Geosystems (<https://myworld.leica-geosystems.com>).
-  You must add your instruments to **myProducts** first, before the instruments can be added to mySecurity.
2. Select **myTrustedServices/mySecurity**.
Available information for listed instruments:
 - Activation date of the mySecurity service
 - Renewal date of the mySecurity service
 - Stolen status, in case of the instrument has been flagged as stolen
3. Click **Add** to add an instrument to mySecurity. Select the instrument from the selectable list. Click **OK**.
4. Select an instrument. Click **Remove** to delete the instrument from mySecurity.

Activating the theft protection

For an active theft protection, the instrument must be connected to myWorld within a defined time interval.

If the instrument is not connected within the defined interval, then the instrument is blocked and cannot be used. In this case, the instrument must be connected to myWorld again and the theft protection must be reactivated.

1. Click the check box to select an instrument.
2. Click **Details**.

3. For **New mySecurity Renewal**, set the start date of the theft protection.
Click **In 3 months**, **In 6 months** or **In 12 months** to define the connection interval.

4. Click **Set**.

5. Download and install the mySecurity Online Update program.

6. The program scans for the instrument connection port automatically. In case automatic scanning fails, click **Scan** for a search of the port.

Select the connection settings.

7. Click **Connect**.

After the activation, the end date of the theft protection is displayed in the mySecurity Online Update program and on the instrument.

8. Press **Close**.

9. Click the Refresh button to update the screen information.

10. Check the status, the activation date and the renewal date of the theft protection.

Status information on the instrument

1. Select **Leica Captivate - Home: Settings>About Leica Captivate**.

2. Go to the **Leica Captivate** page.

3. **mySecurity end date:**
Displays the date when the instrument must be connected to mySecurity. The date is transferred from myWorld to the instrument.

-  Several days before the **mySecurity end date**, a reminder message is displayed each time the instrument is turned on.

-  When the **mySecurity end date** has been exceeded, a message informs about the instrument lock. Go to myWorld to renew the theft protection.

-  When the instrument is locked,
 - all GeoCom commands for functionality are locked.
 - all GeoCom commands for service are locked except the commands for firmware upgrade.
 - a firmware downgrade using GeoCom is impossible.

Report stolen instrument

1. Go to myWorld@Leica Geosystems (<https://myworld.leica-geosystems.com>).

2. Select **myTrustedServices/mySecurity**.

3. Click the check box to select an instrument.

4. Click **Details**.

5. In the **General** section, click **Report as Stolen**.

6. A warning comes up to confirm device as stolen. Click **OK**.

7. The **Status** of the instrument changes to **Stolen!**.
A Leica Geosystems service centre informs local authorities if such an instrument turns up.

Locate stolen instrument

If a reported, stolen instrument is registered to myWorld, then the IP address of the computer is logged. The IP address is used to locate the instrument.

In **myWorld/myTrustedServices/mySecurity**, the **Status** of the instrument changes to **Located**.

Clicking **Show Location** shows:

- The date and time when the instrument was located
 - The IP address of the computer
 - A link to show the location on a map
-

32.1

Overview

Description

Instruments can be equipped with up to two cameras:

Type	Available on
Overview camera	TS16 I, MS60, TS60 I, CS
Telescope camera	TS60 I, MS60

The camera & imaging functionality is an interactive feature embedded in Leica Captivate but used by some apps as well as data management.

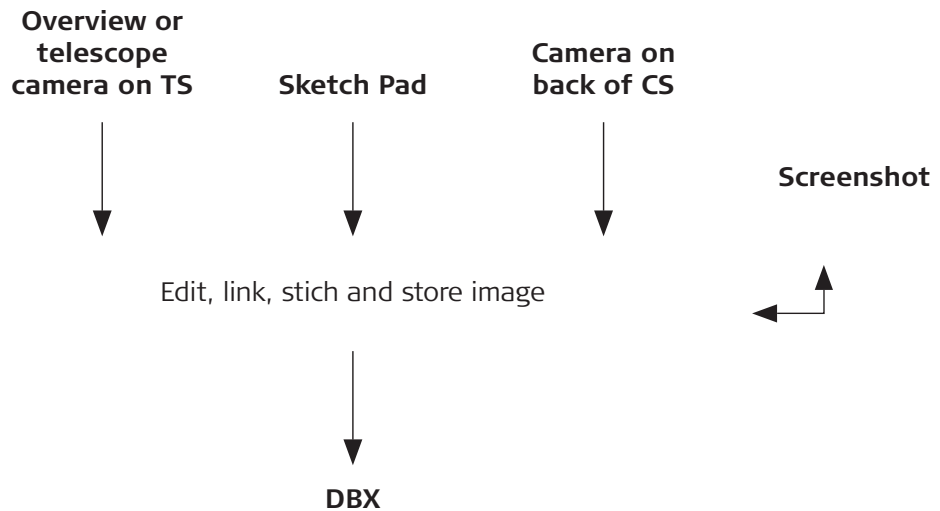

- Camera applications:
 - Taking images of survey relevant objects for documentation purposes
 - Visual aiming using the view finder and the digital crosshair
- The images can be linked to points and lines stored in the job.
- Images can be captured in a defined sequence and combined to a panoramic image.
- Screenshots can be taken from the display as additional information.
- Images, screenshots and digital sketches can be edited and sketched on. This functionality is also available on instruments which do not have a camera or an imaging licence.
- Overview and telescope camera images can be transferred from the TS to the CS.
- Images can be exported in DXF and LandXML format.
- The cameras can be switched.

Depending on where the camera & imaging functionality is accessed from, different functionality is available.



Camera & imaging workflow on the TS

-  The camera functionality on the TS must be licenced.
1. Select **Leica Captivate - Home: Tap here to create new job**. Create a job. Return to the **Leica Captivate - Home** menu.
 2. Select **Leica Captivate - Home: Settings\TS instrument\Cameras**. On the **Overview camera/Telescope camera** page, check **Use TS overview camera/Use TS overview & telescope cameras**. Return to the **Leica Captivate - Home**.

3. Select **Leica Captivate - Home: Setup**. Define the setup. Return to the **Leica Captivate - Home**.
4. Select **Leica Captivate - Home: Measure**. Measure a point.
5. Tap  in the 3D viewer, to switch to the camera view. Tap  to take an image on demand.
6. The image is only displayed, not stored yet.
7. To draw on the image, tap .
8. To store the image, press **Store**.
9. Decide how to link the image:
 - With the last measured point
 - With any point or line
 - No link at all
 - Cancel

32.2

Camera Settings

Access

Select **Leica Captivate - Home: Settings\TS instrument\Cameras**.

**Cameras,
Overview camera/
Telescope camera (for
TS60) page**

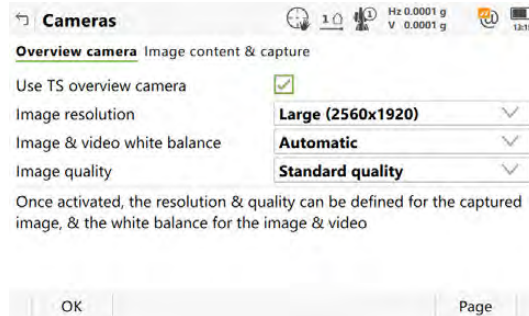

Key	Description
OK	To accept changes and return to Leica Captivate - Home .
Page	To change to another page on this panel.

Description of fields

Field	Option	Description
Use TS overview camera	Check box	Available for TS16 I/MS60/TS60 I. The overview camera can be physically switched on and off. When this box is checked, the camera is switched on.
Use TS overview & telescope cameras	Check box	Available for MS60/TS60 I. The overview AND the telescope camera can be physically switched on and off. When this box is checked, the cameras are switched on.

Field	Option	Description
Image resolution	Selectable list	The resolution has a direct influence on the file size. When images are transferred between TS and CS, select Medium or Small . Small is recommended to save transfer time.
Image & video white balance	Selectable list	This setting defines the colour impression. If Automatic does not provide satisfying results, select Indoor or Outdoor depending on the surveying environment.
Image quality		The grade of compression of the image.
	Highest quality	Low jpg compression, better image quality, larger file size
	Standard quality	Higher jpg compression, standard image quality, smaller file size



Next step

Page to change to the **Image content & capture** page.

Cameras,
Image content & capture page

Key	Description
OK	To accept changes and return to Leica Captivate - Home .
Page	To change to another page on this panel.

Description of fields

Field	Option	Description
Capture image from overview camera for every measured point For MS60/TS60 I also: Capture image from telescope camera for every measured point	Check box	<p>When this box is checked, an image is taken automatically with every measurement. The order of images taken is: 1. telescope camera, 2. overview camera.</p> <p>When this box is not checked, pictures can be taken on demand. Use this option to save power. The active view finder defines the camera source.</p> <p>In apps, use the  icon in the 3D viewer page to take pictures.</p> <p>Outside of apps, tap the Camera bubble icon in the Battery and Time icon pop-up bubble. Then press Capture.</p> <p> Images taken with the camera are always stored related to the active job. The images are stored in a subfolder of the active job. The images can be viewed in the Data Management.</p>

Field	Option	Description
Automatically link captured image to measured point	Check box	<p>Available when Capture image from over-view camera for every measured point or Capture image from telescope camera for every measured point is checked.</p> <p>When this box is checked, the image taken with a measurement is automatically linked to the last measurement taken.</p> <p> Several images can be linked with one point. One image can be linked to several measured points.</p> <p>When this box is not checked, the image taken with a measurement is not automatically linked to a measurement. The image can be linked manually in data management.</p>
Store crosshairs on all captured images	Check box	When this box is checked, the crosshair is stored on the picture.
Store data shown in camera view when pressing 'Capture'	Check box	When this box is checked, point and line information is stored on images taken with Capture . The information stored on the image depends on the distance slider and the settings defined in Object Display and Sort & Filter .
Store second image without overlay data	Check box	When this box is checked, the image without points and lines is saved additionally.

32.3

Taking an Image

32.3.1

Overview

Description

- The camera can be used to take images of survey relevant objects.
- The images can be linked to points and lines stored in the job.
- Screenshots can be taken from the display as additional information in support cases.

Functionality is provided by icons in a groupbar. Some of the functions performed by the icons can also be replicated using a key on the keyboard.

Requirements

- A TS16 I/MS60/TS60 I must be used.
- The camera settings must be active. Refer to "32.2 Camera Settings".
- The documentation settings must be set. Refer to "32.2 Camera Settings".

Access

Tap the **Camera** bubble icon in the Battery and Time icon pop-up bubble. Then press **Capture**.

Capture Image

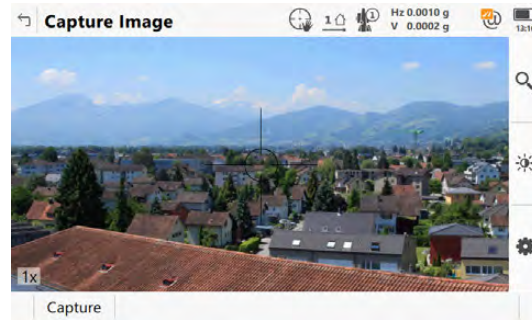

















Key	Description
Capture	To take an image with the current pixel resolution. The image is then displayed but not stored on the data storage device yet.

Tools





Tools are available in groups. The groups available depend on the active app. Click an icon to display the group of related tools.

 To use the hardware keys, close the split panel so that only the 3D viewer is visible.

Icon	Hardware keys	Description
		Camera view To switch to the telescope camera. The style of the crosshairs changes with the camera in use.
		Camera view To switch to the overview camera. The style of the crosshairs changes with the camera in use.
	NAVIGATE	
		Single autofocus To activate a single autofocus. Single autofocus deactivates continuous autofocus. Same functionality as pressing the autofocus button on the side cover of the instrument.  While continuous autofocus is active, any manually measured distance updates the focus position.

Icon	Hardware keys	Description
		Continuous focus on To switch on continuous autofocus.
	2	Zoom + To zoom into the image.
	3	Zoom - To zoom out of the image.
	BRIGHTNESS	
		Auto Bright To turn on automatic brightness.
		Bright + To increase the brightness from the current value.
		Bright - To decrease the brightness from the current value.
	SET	
		CAD layers To turn layers of background maps (CAD files) on and off. Refer to "6.2 Creating a New Job" for information on CAD files.
		Settings To define the display settings. Change the cross-hair colour, what is displayed in the 3D viewer, separately to the plan or orbital views.
		Data range To define a range from the eye point by a minimum and maximum distance. Only data within the range is displayed.

Icon	Hardware keys	Description
		<p>Top slider The maximum distance from the eyepoint, for example set to 400.</p> <p>Bottom slider The minimum distance from the eyepoint, for example set to 10.</p> <p>Result Points between 10 m and 400 m from the eyepoint are displayed on the image.</p>
		To move the slider, tap on the slider, hold and drag it.

SKETCH		
		<p>Erase To remove sketched lines by moving the stylus over the area.</p>
		<p>On/off To activate sketching.</p>
		<p>Line colour To change the line colour. Tap the icon to open a window displaying line colours for selection. Move the stylus over the window to display more colours. The selected line colour is remembered.</p>
		<p>Line weight To change the line width. Tap the icon to open a window displaying line widths for selection. The selected line width is remembered.</p>
		<p>Text mode on/off To type text into the image. Use the keys on the keypad. Tap the screen to specify the insertion point of the text.</p>

32.3.3

Within Apps



Access

In apps, the map is displayed by default.

In Measure

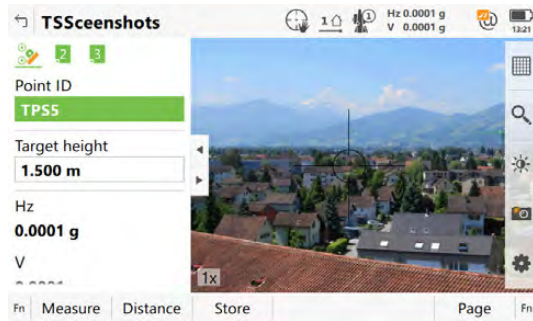
The style of the crosshairs changes with the camera in use.
Refer to "Tools" for information on the toolbar.



Key	Description
Measure	To measure and store distances and angles. If configured, an image is taken automatically. If configured, the image is linked to the point measurement automatically.
Stop	Available if Measure distance: Continuously and Distance was pressed. Stops the distance measurements. The key changes back to Measure .
Distance	To measure and display distances.
Store	To record data. If Measure distance: Continuously and/or Automatically measure points is checked, measured points are recorded and tracking continues. If configured, an image is taken automatically. <div style="margin-left: 20px;">  Depending on the setting, crosshairs are stored on top of the image.  For the overview camera: If a valid distance measurement is available, then the parallax is corrected and the crosshairs are overlaid on the image on their true position. </div>
Page	To change to another page on this panel.
Fn Display	To configure what is displayed in 3D viewer. Refer to "Object Display, General page".
Fn Tools	Refer to "37 Apps - The Toolbox".

In Total Station Setup

In the Setup app, points can be linked with images. Depending on the setting, the images are linked either automatically or manually.

A **Camera** page is displayed. Depending on the panel, the available keys differ. The style of the crosshairs changes with the camera in use.

Click  to take an image with the current pixel resolution. The image is then displayed but not stored on the data storage device yet. In case of multiple backsight setups, link the image with the next or the previous target.

Key	Description
OK	For Setup method: Set orientation : To set the setup and orientation and exit the Setup app. If configured, an image is taken automatically, also for two face measurements. If configured, the image is linked to the point measurement automatically.
Measure	For Setup method: Multiple backsights : To measure and store the distances and angles made to the control points. If configured, an image is taken automatically, also for two face measurements. If configured, the image is linked to the point measurement automatically. For measurements in two faces, two images are linked with one point.
Distance	To measure and display distances.
Store	For Setup method: Set orientation : To store the measurement with or without a distance. For Setup method: Multiple backsights : To record display values temporarily. The target measurements are not stored to the current job until the setup is set. If configured, an image is taken automatically, also for two face measurements. If configured, the image is linked to the point measurement automatically. For measurements in two faces, two images are linked with one point.
Page	To change to another page on this panel.
Fn Display	To configure what is displayed in 3D viewer. Refer to "35.3 Configuring 3D viewer".

**Object Display,
General page**

Description of fields

Field	Option	Description
Display crosshairs	Check box	For TS: If no distance is measured, then the coarse-style crosshair is indicated which is approximately the field of view. If a valid distance is measured and the parallax can be resolved, then the fine-style crosshair is indicated as two intersecting lines on the true position. When the instrument turns about three gon in horizontal or vertical direction after measuring a distance, then the crosshair style changes back to the field of view variant. In tracking mode, the crosshairs are always on the correct position and displayed as two intersecting lines. When locked onto a prism, the crosshair style adapts with distance measurements.

Field	Option	Description
Crosshairs colour	Selectable list	Available if Display crosshairs is checked. Defines the colour of the crosshairs.

Next step

Page to change to the **Points** page.

Object Display, Points page

Description of fields

Field	Option	Description
Points	Check box	When this box is checked, points from the job with 3D local grid coordinates are displayed on the view finder. Use the display of points to check completeness and reliability of the survey. Points are displayed with a visual 3D effect: Points further away from the instrument are displayed smaller than points closer to the instrument.
Point IDs, Point codes, Height of points	Check box	When this box is checked, the relevant information of a measured point is displayed next to the point symbol.
Only show points measured from current setup	Check box	In addition to the selected number of points, the points displayed can be restricted further by showing only points measured from the current setup.

Next step

Page changes to the **Lines & alignments** page.

Object Display, Lines & alignments page

Description of fields

Field	Option	Description
Lines	Check box	When this box is checked, lines from the job with 3D local grid coordinates are displayed on the view finder. Use the display of points to check completeness and reliability of the survey. Points are displayed with a visual 3D effect: Points further away from the instrument are displayed smaller than points closer to the instrument.  Points are only displayed on the image. They are not saved with the image.
Line IDs	Check box	When this box is checked, then the line IDs are displayed with the lines.

Field	Option	Description
Alignments	Check box	When this box is checked, then the active alignment of the active Rail, Road or Tunnel job is displayed.
Alignment ID	Check box	When this box is checked, then the line IDs for all shown alignments are displayed in.
Lines & alignments size		Determines the thickness of selected and non-selected lines.
		Non-selected lines Selected lines
	3 pixels	3 pixels 6 pixels
	2 pixels	2 pixels 4 pixels
	1 pixel	1 pixels 3 pixels

Next step

Page changes to the **Scans** page.

Object Display, Scans page

Description of fields

Field	Option	Description
Scans	Check box	When this box is checked, then scan areas previously defined are displayed in 3D viewer.
Colour scans using	Selectable list	This colour is used for the previously defined scan areas.
Point cloud point size	Selectable list	This size is used for the points of the scan areas.

Next step

Page changes to the **DTM** page.

Object Display, DTM page

Description of fields

Field	Option	Description
DTMs	Check box	When this box is checked, then the active DTM of the DTM job is displayed in 3D viewer.
DTM colour	Selectable list	This colour is used for the DTM and for the text related to the DTM.

Next step

Page changes to the **Background image** page.

Description of fields

Field	Option	Description
Display image (press 'Images' to select which images to show)	Check box	When this box is checked, then background images are displayed in 3D viewer.

32.3.4

Screenshot

Description

Press  and .

The screenshot is displayed and can be edited by sketching.

The screenshot can be linked with points manually. Sketching on the screenshot is possible.

The screenshot is stored as jpg with a predefined compression rate. The resolution is 640 x 480. Screenshots can be georeferenced by linking to a point. Screenshots cannot be orientated and calibrated.

32.3.5

Panoramic Imaging

Description

A panoramic image is a combination of single images. Panorama images show the area of what can be seen from the instrument setup. Panorama images are used for documentation purposes and support the evaluation of the surveying data directly in the field or in the office. Panorama images can be imported into Infinity.

Panoramic images can be generated independent of any app.

A panorama is organised with a panorama instance within the DBX. The single images are stored in the DBX\JOB\IMAGES folder of the data storage device. The single images are named `Img_Pano_x_y_date_time.jpg`.

Field	Description
x	Number of the row, starts with upper left corner
y	Number of columns, starts with upper left corner data
Date	Same as with normal images
Time	Same as with normal images



Panoramic images can only be generated with motorised instruments with overview camera (TS16 I/MS60/TS60 I).

Access

In **Leica TS Favourites** click **Panoramic image**.

OR

Press a function key configured with the option **User - Capture panoramic image**.

OR

At the end of Setup, a panoramic image can be taken.

Define Panoramic Image

Description of fields

Field	Option	Description
Image type	Rectangular area	Area defined by upper left and lower right corner
	Multi-row 360° image	360° with one or more rows above each other
	Single row 360° image	360° in one row
	Polygonal area	Area defined by three or more corners in clockwise direction.

Next step

OK and follow the instructions on the panel to define the area.

Once the panoramic image area is defined then the **Panoramic Image Capture** panel opens.

Panoramic Image Capture

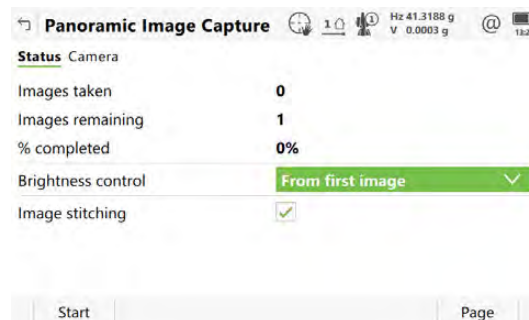

Key	Description
Start	To start taking the panorama images.
Stop	To end taking the panorama images.
Pause	To pause taking the panorama images.
Resume	To continue taking panorama images after Pause has been pressed.
Fn Exit	To exit the panel.

Description of fields

Field	Option	Description
Images taken	Display only	The number of captured images.
Images remaining	Display only	The number of images remaining to be taken.
% completed	Display only	In percent, the number of images taken against the total number of images which must be taken.

Field	Option	Description
Image file name	Display only	The name of the file where the image is stored to.
Brightness control	From first image	To control the brightness of each tile of the panorama image. The brightness is measured for first image of the panorama. The value is applied to all further tiles. Recommended for panorama images taken under normal conditions
	From each image	The brightness is measured for each image of the panorama. Recommended for panorama images with diverse brightness.
Image stitching	Check box	When this box is checked, a stitched panoramic image is created and stored. Possibilities: <ul style="list-style-type: none"> • Colouring of any related scan • Panoramic image is exported to any export • Documentation onboard Stitching combines multiple images with overlapping fields of view to one segmented panorama or high-resolution image. When this box is not checked, the image is not stitched. No name of the panoramic image is added to the DBX.

Next step

The panorama and the images are stored in the images folder of the job, either with or without link to the reference triplet of the current setup.



An image belonging to a panorama image can be linked manually with another object without affecting the panorama image.

32.4

Image Management



Image Management is available on instruments which have a camera.

Access

1. Select **View & edit data** from the job menu.
2. **Page** until the **Images** page is active.

**Job name,
Images page**

Listed are all images in the job with information about the image size and the time and the date of when the image was stored.

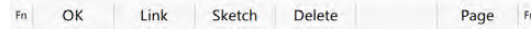
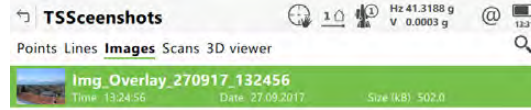

Key	Description
OK	To close the panel and return to the panel from where this panel was accessed.
Link	To display a points list and to link the image to a point.
Sketch	To display an image and to draw on the image. Refer to "Image Viewer".
Delete	To delete the highlighted image and all its links.
Page	To change to another page on this panel.
Fn Filter	To define sort and filter settings. Refer to " Sort & Filter, Images page".

Image Viewer

Use the arrow keys on the keypad to move the image on the panel.

Key	Description
Store	To store the image with the added link or a sketch created. If no sketch was created, then the image is not stored a second time to avoid a loss of quality.
Previous	To display the previous image in the list of images. Available unless the beginning of the list is reached.
Next	To display the next image in the list of images. Available unless the end of the list is reached.

Next step

Store returns to **Job name, Images** page.

**Sort & Filter,
Images page**

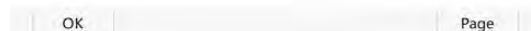
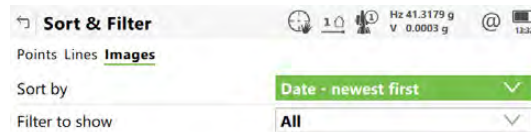

Key	Description
OK	To close the panel and return to the panel from where this panel was accessed. The selected sort and filter settings are applied.
Page	To change to another page on this panel.

Description of fields

Field	Option	Description
Sort by	File name - ascending,	Always available. The method the images are sorted by.
	File name - descending,	
	Date - oldest first and	
	Date - newest first	
Filter to show	All	Always available. The method by which the images are filtered. Shows all images.
	Image source	Shows photos taken with the camera or screenshots. Make the selection in the Image source field.
	Camera type	Shows images taken with the TS16 or CS camera. Make the selection in the Camera type field.
	Linked / unlinked	Shows linked or unlinked images. Make the selection in the Image field.
Image source		Available for Filter to show: Image source .
	Camera	Shows images taken with the camera on the TS16 or CS.
	Screenshot	Shows pictures taken from the instrument panel.
	Field sketch	Shows field sketches created.
Camera type		Available for Filter to show: Camera type .
	Overview camera	Shows images taken with the overview camera on the instrument.
	CS camera	Shows images taken with the camera on the CS.
	Telescope camera	Shows images taken with the telescope camera on the instrument.
Image	Selectable list	Available for Filter to show: Linked / unlinked . Either linked or unlinked images are displayed.

Next step

OK returns to **Job name, Images** page.

32.5

Sketching on Images

Description

A sketch can be overlaid on an image taken with a camera.

A sketch can be made on every jpg file stored in the DBX\JOB\IMAGES folder of the job.

The sketch is stored together with the image in jpg format. The compression rate is specified in the **Cameras** panel.

Access step-by-step

In data management

The image is already stored and possibly linked.

1. Select **View & edit data** from the job menu.
2. **Page** until the **Images** page is active.
3. Press **Sketch**.
4. Click the  icon in the toolbar.
Refer to "Tools" for a description of icons.

For images

1. Start the Measure or Setup app and go to 3D viewer.
2. Click the  icon. The image is taken as with a digital camera.
3. Click the  icon in the toolbar.
Refer to "Tools" for a description of icons.



For screenshots

1. Press **Fn**  and .
2. The screenshot is displayed and can be edited by sketching.

32.6

Exporting Images

Exporting images in DXF format

1. Select **Export data\DXF** from the job menu.
2. **Fn Settings** goes to **Settings, Objects to be exported** page.
3. Checking **Images** activates the export of images linked with any point or line.
 -  If multiple images are linked with one point or one line, then all images linked are exported.
 -  Images are exported according to the filter settings. Press **Filter** to check the settings.

Exporting images in XML format

1. Select **Export data/XML** from the job menu.
2. **Fn Settings** accesses **Settings, Export** page.
3. Checking **Images** activates the export of images linked with any point or line.
 -  Images are exported according to the filter settings. Press **Filter** to check the settings.

33

TS Functions

33.1

EDM

Description

Electronic **D**istance **M**easurement **EDM** is the function used for distance measurements.

There are different modes the instrument can work in. Refer to "22.1.1 Measure & Target".

33.2

Prism Search Methods

33.2.1

Automatic aiming

Description

Automatic aiming is the function which recognises and measures the position of a prism using a CCD array. A laser beam is transmitted and the built-in CCD array receives the reflected beam. The position of the reflected spot is computed regarding the centre of the CCD. These automatic aiming offsets are used to correct the horizontal and vertical angles. The automatic aiming offsets are also used to control the motors which turn the instrument to centre the crosshairs to the prism. In order to minimise the time for measuring, the crosshairs are not moved to the exact centre of the prism. The automatic aiming offset can be up to 500 cc depending on selected **Measure distance**. The automatic aiming function measures the offsets between the crosshairs and prism centre and corrects the horizontal and vertical angles accordingly. Therefore the horizontal and vertical angles are measured to the prism-centre, even if the crosshairs are not aimed precisely at the centre of the prism.

Motorised instruments can be equipped with automatic aiming. For **Aim at target: Automatic** the instrument can find a static prism and measure a distance once **Measure** or **Distance** is pressed. The instrument does not follow a moving prism.

Field of view

The telescope field of view is the region seen when looking through the telescope. The automatic aiming field of view is the region seen by the automatic aiming. Both are identical on TS instruments.

Automatic aiming measurement

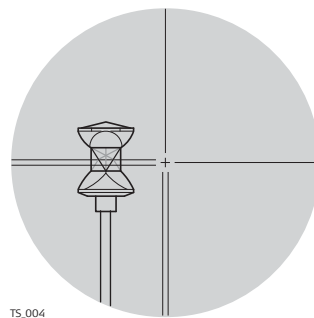

If the prism is in the field of view with **Aim at target: Automatic** the crosshairs are automatically positioned to the prism when, for example **Measure** or **Distance** is pressed. No automatic aiming search is started.



The displayed values are always related to the centre of the prism after **Measure** or **Distance** is pressed. For **Measure**, these values are displayed only shortly after the key press.

The crosshairs of the telescope may not fully coincide with the centre of the prism when viewed through the telescope. The remaining automatic aiming offsets for the horizontal and vertical angles are measured by the automatic aiming function and applied to the measured and displayed angles.

Automatic aiming search

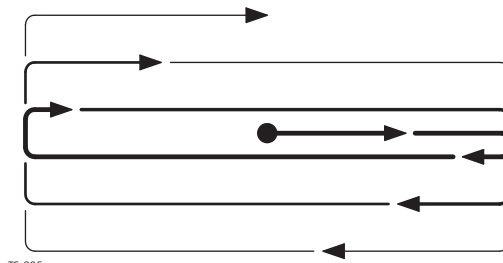

If the prism is not in the field of view when **Measure** or **Distance** is pressed, an automatic aiming search is started. For the automatic aiming search the automatic aiming window is scanned line by line starting at the current telescope position.

If the prism was not found

- **Search** can be pressed to search for the prism in an increased area. The telescope move automatically.
- **Retry** can be pressed to search for the prism under unfavourable conditions. The telescope does not move. Make sure that the prism is within the field of view.

If the prism was found

The automatic aiming measurement is performed to position the telescope to the centre of the prism.

Automatic aiming window

The automatic aiming window is a relative window based on the current telescope position. The horizontal and vertical extent can be defined.

Fine search window

If no target is found after the prediction time and **If no target found after prediction then: Start fine search** is set, then the prism is searched for with automatic aiming using a dynamic automatic aiming window. This window covers a horizontal region from the position of loss of lock to the current telescope position, and the same extent on the other side. The vertical dimension of the dynamic window is one third of the horizontal expansion.

Targeting modes

Refer to "22.1.1 Measure & Target".

33.2.2

PowerSearch

Description

The PowerSearch module allows an automatic prism detection within a short time period. The PowerSearch function can be started in the icon bar and configured in **Settings\TS instrument\Target search, PowerSearch window** page.

Functionality

The PowerSearch function consists of a transmitter (a) and a receiver (b). Both are installed in the telescope.

When PowerSearch is activated, the instrument starts to rotate around its standing axis. The transmitter emits a vertical laser swath. If the laser swath

detects a prism, the rotation of the instrument is stopped. Afterwards an automatic aiming measurement in the vertical direction is performed.

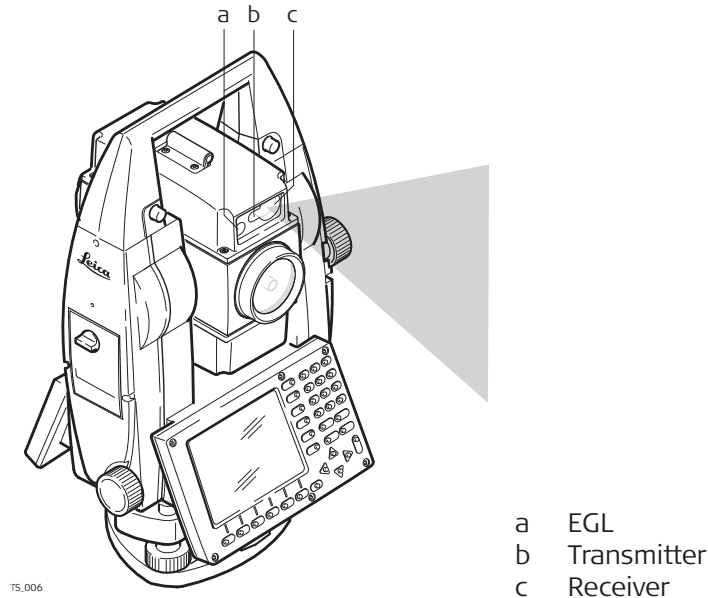

If a PS filter is active, PowerSearch ignores the prisms defined in the filter.



If a PS window is defined and active, PowerSearch is executed within the defined limits.

360° search

If the search window is not defined and PowerSearch is started, the prism is searched for with PowerSearch in the 360° window. The default search with PowerSearch consists of a short swing in anti-clockwise direction followed by a complete 360° turn in clockwise direction. If a prism is detected the movement is stopped and an automatic aiming search is performed.

PowerSearch filter

A PowerSearch filter can be applied to exclude disturbing prisms from PowerSearch.

The PowerSearch filter can be defined in two ways:

1. Performing a PowerSearch scan:
Select the **Filter learn** bubble icon in the **Aim & Search** icon pop-up bubble.
2. Adding setup points to the PowerSearch filter:
In the **Setup** app, check **Add target points to the PowerSearch filter** in the **Settings, General** page.

The PowerSearch scan finds prisms and other reflective spots in the surrounding of the instrument. Around each found prism or reflective spot, an exclusion area is defined. The exclusion area has the dimension of $H_z = \pm 1$ gon, $V = \pm 50$ gon and $d = \pm 12$ m.

After defining the filter, the filter is switched on: **Filter on** is displayed in the **Aim & Search** icon pop-up bubble.

The PowerSearch filter can be switched on and switched off in the **Aim & Search** icon pop-up bubble.

After clicking the **Filter off** bubble icon, the filter is deactivated, but not deleted. The filter can be switched on again using **Filter on**.

When no filter is learned, the bubble icons **Filter on** and **Filter off** are not shown.

When pressing the **Filter learn** bubble icon, the instrument performs a PowerSearch scan. The scan order is:

- 400 gon PowerSearch rotation around Hz with a V angle of 100 gon
- 400 gon PowerSearch rotation around Hz with a V angle of 60 gon
- 400 gon PowerSearch rotation around Hz with a V angle of 140 gon

When learning the filter, a previous filter is deleted.

When measuring new points for a setup, the current filter is updated.

The PowerSearch filter is reset after a new setup.

The PowerSearch filter is kept when shutting down and restarting the instrument.

PowerSearch window

The PowerSearch window can be defined individually. It is specified by absolute angle values and does not change its position. The PowerSearch window can be set in the **Target Search, PowerSearch window** page by aiming at two opposite points of the PowerSearch window. When **Use PowerSearch window** is checked and a PowerSearch is started, a prism is searched for within the defined window.

Dynamic PowerSearch window

When **Use PowerSearch window** is not checked and the instrument has lost lock, after the prediction time, the prism is searched for in a dynamic PowerSearch window. This window covers a region at the position after prediction of horizontal 100 gon by vertical 40 gon.

Direction of search

The PowerSearch routine can be activated clockwise or anticlockwise by using hotkeys. This action will have no influence on the prism search settings.

33.3

Follow Moving Prisms - Lock

Description

Lock enables instruments equipped with automatic aiming to follow a moving prism. The automatic aiming sensor is active when Lock is active. When **Target lock on** is selected in the icon bar, an automatic aiming search is executed. The instrument locks onto the prism and follows its movements. Automatic aiming offsets are continuously applied to the angle measurements. When the instrument loses lock to the prism, a PowerSearch or fine search (auto aiming search) can be executed depending on the prism search settings.

Lock is unavailable for SmartStation.



If the speed of the prism is too fast, the target may be lost. Make sure that the speed does not exceed the figure given in the technical data.

Enable lock

Selecting **Target lock on** in the icon menu, will immediately activate an automatic aiming search to find the prism. Alternatively, as long as **Aim at target** is set to **With lock** in **Measure & Target**, then pressing **Measure, Distance, PowerSearch, OK** in **Check Point** and **Turn Using Arrow Keys, Turn Instrument to Hz/V** and starts a PowerSearch or automatic aiming search to find the prism. When the prism is found, the instrument locks onto the prism. The instrument follows the moving prism and the automatic aiming function remains active.

Loss of lock

When the instrument is locked onto a prism, lock may be lost if the movement of the prism is too fast for the instrument to follow or the prism is hidden behind an object. After lock is lost, the prediction, as set in **Target Search** is used to find the prism again.

The automatic aiming function is still active.



Whenever the prism is moved in the field of view during the prediction and any other search periods, the instrument locks automatically to the prism.

Prediction

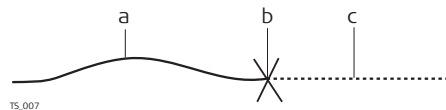

- a Moving prism locked onto by the instrument
- b Loss of lock
- c Prediction

As long as the prism is being tracked by the instrument a mathematical filter continuously calculates the average speed and direction of the prism. If the line of sight between instrument and prism is disturbed, the instrument keeps on moving using these calculated values. This behaviour is called prediction. The prediction time can be configured. During prediction, the LOCK icon is displayed and if the prism comes into the instruments field of view again the automatic aiming will lock to the prism.

Prism search after prediction

After prediction, the prism is searched for depending on the settings in **Target Search**.

- **If no target found after prediction then: Wait & lock.** If the prism moves into the field of view, the prism is not searched for until **Measure, Distance, Target lock on** is pressed.
- **If no target found after prediction then: Start fine search:** prism is searched for in the dynamic automatic aiming window with automatic aiming.
- **If no target found after prediction then: Start CubeSearch and Use PowerSearch window** is checked: prism is searched for in the PS window with PowerSearch.
- **If no target found after prediction then: Start CubeSearch and Use PowerSearch window** is NOT checked: prism is searched for in the dynamic PowerSearch window.

Relock

Independent of the setting for **If no target found after prediction then** the instrument can relock to the prism. Refer to paragraph "Enable lock".

33.4

Remote Mode

Description

The instrument can be controlled by the field controller using radio. The automatic aiming function does not necessarily have to be active when working in remote mode. The field controller is used to remote control the instrument. No data can be stored on the field controller. The panel and content displayed on the field controller are a copy of the remote controlled instrument.

The communication between the total station and the field controller is established using radio modems. One radio modem must be connected to the total station serial port.

33.5

EGL

Description

The **Emitting Guide Light**, EGL, consists of two differently coloured flashing lights in the telescope housing of the TS. The EGL is used for guidance into the line of sight. If the left light is seen, the prism must be moved right and vice versa. If both flashing lights can be seen, the prism is in the line of sight of the instrument.

Functionality

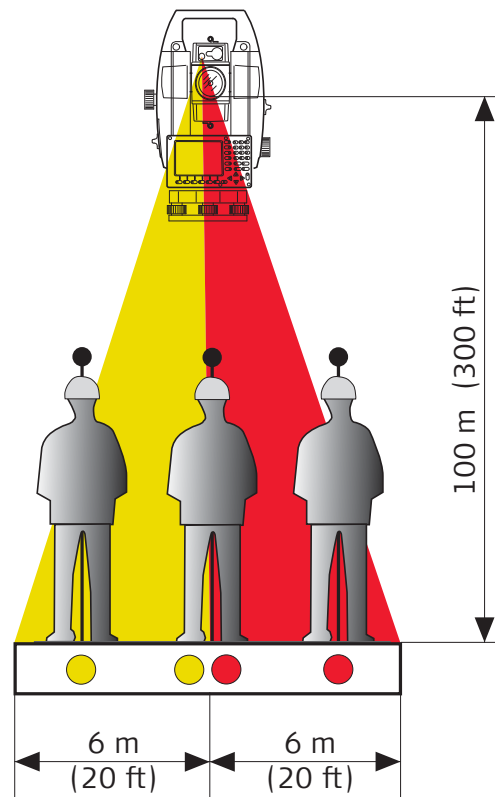

TS_008

The EGL can be used

- to help guide the prism into the telescope line of sight when the instrument is controlled remotely and **Aim at target: With lock**.
- to stake out points.

The instrument emits two differently coloured flashing cones of light. At a target distance of 100 m, the cones have a width of 6 m. Between the two cones of light, a sector with a width of 30 mm is created where both guide lights are

visible simultaneously. In this position, the prism is in the line of sight of the instrument.

Using the EGL step-by-step

1. Check **Use the instrument guide lights (EGL)** in the **Instrument Lights** panel.
OR
Set **Aim at target: With lock** and press **Turn to Hz/V** in the icons menu.
 2. Align instrument line of sight and prism, where both flashing EGL lights can be seen simultaneously.
 3. **OK** to lock onto the prism.
 4. If the instrument has locked onto the prism the EGL is turned off automatically.
-  If the EGL was turned on in **Instrument Lights**, it must be turned off by unchecking the check box.

33.6

Illumination

Description

There are several different illumination types built into the instrument that all fulfil different functions. Some are to support measurements, for example the visible red laser pointer. Others, such as the screen illumination, are for more convenient work with the instrument. These different types of illumination are described in this chapter.

Laser plummet

The laser plummet allows setting up the instrument over a marked point. The laser beam is emitted from the bottom of the instrument, pointing to the ground. When the instrument is levelled and the laser beam points exactly at the ground point, the instrument is set up correctly.

The laser plummet can be turned on and off. It is turned on automatically when opening **Settings\TS instrument\Level & compensator**.

Visible red laser pointer

The visible red laser pointer is used to measure to any surface. The visible red laser pointer is arranged coaxially with the line of sight of the telescope and emitted through the objective. If the instrument is correctly adjusted, the visible red laser beam coincides with the line of sight.



The direction of the beam should be inspected before precise distance measurements are executed. An excessive deviation of the laser beam from the line of sight can cause inaccurate results.

33.7

Connection to Other Total Stations

33.7.1

Leica Legacy Total Stations

Supported functions

Function	TPS300 TPS400 TPS700	TPS700A	TPS800	TPS1000 TPS1100
Robotic control	-	-	-	-
Auto aiming	-	✓	-	✓

Function	TPS300 TPS400 TPS700	TPS700A	TPS800	TPS1000 TPS1100
Level bubble	-	-	-	-
Auto aiming in setup	-	✓ ¹	-	✓ ¹
Compensator on/off	✓	✓	✓	✓
Laser plummet on/off	✓	✓	✓	-
Laser pointer on/off	✓	✓	✓	-
EGL on/off	✓	✓	✓	✓
Connection status	✓	✓	✓	✓
TS battery status	-	-	-	-
Move between measurements to any surface or prism	✓	✓	✓	✓
Measure distances continuously	✓	✓	✓	✓
Auto logged points	✓	✓	✓	✓

✓ Supported

- Not supported

¹ The auto aiming function when doing a setup only works if a distance is measured. The **Meas** or **Dist** key must be used. When using the **Store** key only, the auto aiming function in setup is unavailable.



SmartPole and SmartStation are not supported with Leica Legacy instruments.



Prism constants and correction values set at the CS are applied to the raw measurement data taken from the total station.

33.7.2

Topcon

Supported functions

Function	GTS GPT GPT-L	GTS800 GTS820 GTS900	GPT8000 GPT8200 GPT9000
Robotic control	-	-	-
Auto aiming	-	-	-
Level bubble	-	-	-
Compensator on/off	-	-	-
Laser plummet on/off	-	-	-
Laser pointer on/off	-	-	-
EGL on/off	✓	✓	✓
Connection status	✓	✓	✓
TS battery status	-	-	-

Function	GTS GPT GPT-L	GTS800 GTS820 GTS900	GPT8000 GPT8200 GPT9000
Move between measurements to any surface or prism	✓	✓	✓
Measure distances continuously	-	-	-
Auto logged points	-	-	-
✓ Supported			
- Not supported			



Prism constants and correction values set at the CS are applied to the raw measurement data taken from the total station.

33.7.3

Sokkia

Supported functions

Function	Sokkia Set030R/220/010	Sokkia Set10/10K Series Sokkia Set 20/20K Series Sokkia Set 30R/30RK/130R	Sokkia Set 110 Series Sokkia Set110R Sokkia Set 120 Series	Sokkia Set 110M Series	Sokkia Set 230RM Series	Sokkia Set300/500/600 Sokkia SRX Series	Sokkia Set X Series Sokkia Set SCT6
Robotic control	-	-	-	-	-	-	-
Auto aiming	-	-	-	-	-	-	-
Level bubble	-	-	-	-	-	-	-
Compensator on/off	-	-	-	-	-	-	-
Laser plummet on/off	-	-	-	-	-	-	-
Laser pointer on/off	-	-	-	-	-	-	✓
EGL on/off	-	-	-	✓	-	✓	-
Connection status	✓	✓	✓	✓	✓	✓	✓
TS battery status	-	-	-	-	-	-	-
Move between measurements to any surface or prism	1	-	-	-	✓	✓	✓
Measure distances continuously	✓	✓				✓	✓
Auto logged points	✓	✓	n/a	n/a	n/a	✓	✓
Others	2	-	-	-	-	-	-
✓ Supported							

- Not supported
- n/a Not available
- 1 Set **Prism** or **Any surface** distance measurements at the instrument.
Set the correct prism constant at the controller.
- 2 Setup not available. Set horizontal angle at instrument.



Prism constants and correction values set at the CS are applied to the raw measurement data taken from the total station.

33.7.4

Nikon

Supported functions

Function	Nikon 800 Series	Nikon A Series	Nikon DTM300 Series	Nikon DTM330 Series Nikon NPL330 Series	Nikon DTM500 Series	Nikon Nivo C Nikon Nivo M
Robotic control	-	-	-	-	-	-
Auto aiming	-	-	-	-	-	-
Level bubble	-	-	-	-	-	-
Compensator on/off	-	-	-	-	-	✓
Laser plummet on/off	-	-	-	-	-	-
Laser pointer on/off	-	-	-	-	-	-
EGL on/off	-	-	-	-	✓	-
Connection status	✓	✓	✓	✓	✓	✓
TS battery status	-	-	-	-	-	-
Move between measurements to any surface or prism	-	-	-	✓	-	✓
Measure distances continuously	n/a	✓	-	✓	✓	✓
Auto logged points	n/a	n/a	-	✓	✓	✓
Others	-	1	-	-	-	-

- ✓ Supported
- Not supported
- n/a Not available
- 1 Setup not available. Set horizontal angle at instrument.



Prism constants and correction values set at the CS are applied to the raw measurement data taken from the total station.

34

NTRIP via Internet

34.1

Configuring Access to the Internet



Configure an Ntrip connection using the **RTK Rover Wizard**. Select **Leica Captivate - Home: Settings\Connections\RTK rover wizard** and follow the on-panel instructions.

The remainder of this chapter describes each of the steps and panels when configuring without the use of the **RTK Rover Wizard**.



For TS: One Internet interface is available - the **CS internet**.

For GS: Two Internet interfaces are available - the **CS internet** and the **GS internet**.

The **CS internet** is used as an example. The explanations are also valid for the **GS internet**.



To access the Internet with a GS or TS instrument, **General Packet Radio System** devices are normally used. GPRS is a telecommunication standard for transmitting data packages using the Internet Protocol (IP).

Select the Internet interface

Select **Leica Captivate - Home: Settings\Connections\All other connections**.

On the **CS connections** page highlight **CS internet**.

Press **Edit**.

Configure the Internet interface

Internet Connection

Internet Advanced

Use Internet connection on CS

Connect using CS Bluetooth 1

Device Nokia Phone

Bluetooth ID -----

Connect to internet using Mobile data

Use user ID & password

OK Search Device Page

1. Select a port (**Connect using**).
2. Select a device (**Device**).
3. If necessary, enter **User ID** and **Password**. Some providers ask for a **User ID** and a **Password** to allow connecting to the Internet using GPRS. Contact your provider if user ID and password are required.
4. **OK** to return to **Connection Settings**.
5. In **Connection Settings** press **Control**. Continue with the next paragraph.

Configure the Internet Connection

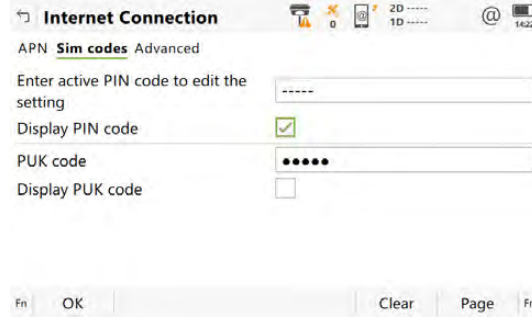
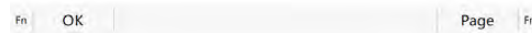
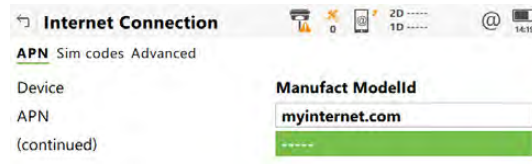

1. On the **APN** page, type in the **APN (Access Point Name)** of a server from the network provider). Contact your provider to get the correct APN.
2. On the **Sim codes** page, type in the **Enter active PIN code to edit the setting** for the SIM card.
If the PIN is locked for any reason, for example the wrong PIN was entered, input the **Personal Unblock**ing code for access to the PIN.
3. **OK** twice to return to the **Leica Captivate - Home**.
The instrument is now online to the Internet. The Internet online status icon is displayed. But because GPRS is being used, no charges are yet made since no data transfer from the Internet has yet taken place.

Check the status of the Internet connection

For CS

1. Tap on @ in the icon bar.
2. Select **Internet status**. This icon is only available if an Internet connection is configured.
3. Check the Internet online status.
4. **OK** to return to the **Leica Captivate - Home**.

For GS



Configure the **RTK rover**, if you have configured the **GS internet**.

1. Tap on ⚡ in the icon bar. This icon is only available if an Internet connection is configured.
2. Select **RTK data link stat**.
3. Check the Internet online status on the **Connectivity** page.

4. **OK** to return to the **Leica Captivate - Home**.

34.2

Using the NTRIP Service with a Real-Time Rover

Select the Internet interface

Select **Leica Captivate - Home: Settings\Connections\All other connections**.

On the **GS connections** page highlight **RTK rover**.

Press **Edit**.

Settings for the RTK rover

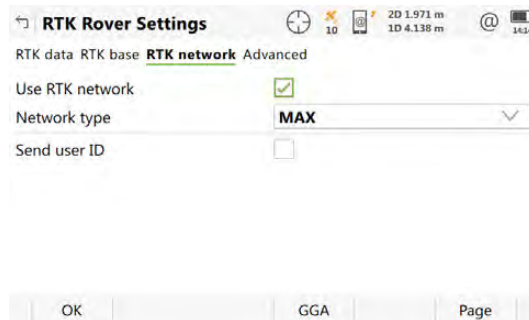
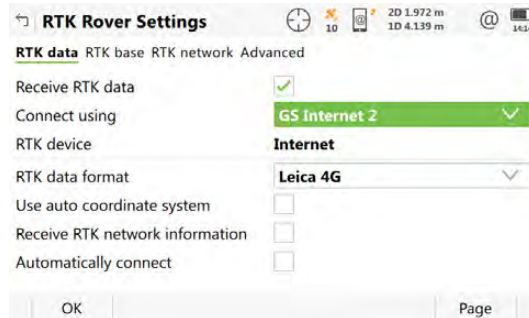

1. On the **General** page, make sure that an Internet port is selected for **Connect using**.
2. On the **RTK network** page, enable **Use RTK network**.
3. Press **OK** to return to **Connection Settings, GS connections** page.
4. Press **Control** to access **Internet Port Connection**. Continue with the next paragraph.

Select the server to be accessed in the Internet

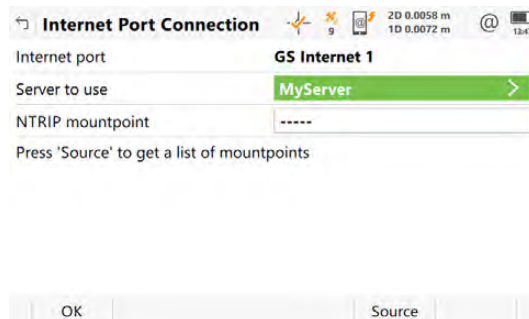

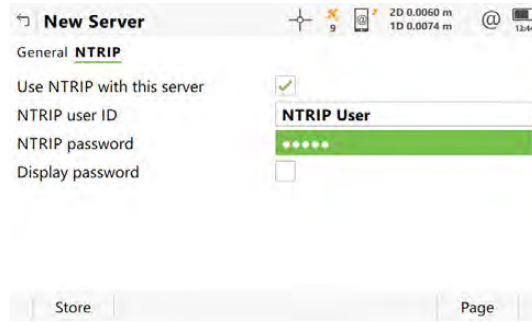
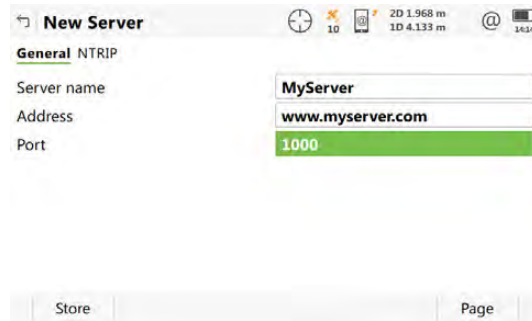

1. The **Server to use**, must be Ntrip enabled. To create a server click into the selectable list.

2. In **New Server, General** page, type in the address and the port of the server through which the data is provided. Each server has several ports for various services.

3. In **New Server, NTRIP** page, activate the use of Ntrip.

4. Type in the **NTRIP user ID** and the **NTRIP password**. A user ID and the password are required to receive data from the Ntrip Caster. Contact the Ntrip administrator for information.

5. **Store** followed by **OK** to return to **Internet Port Connection**.

Select the Ntrip mountpoint

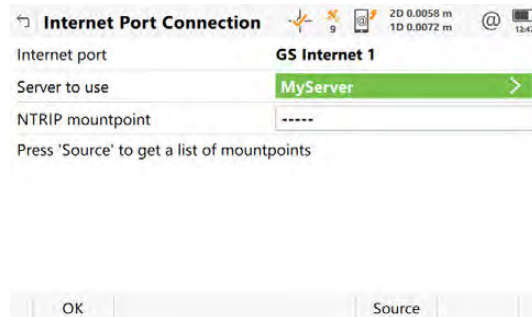



1. If the selected server is Ntrip enabled, Ntrip mountpoint is available.
2. Press **Source** to access **NTRIP Source Table**.
3. All mountpoints are listed. Mountpoints are the Ntrip servers sending out real-time data. This panel consists of two columns. The first column shows the names for the mountpoints. The second column shows the identifiers of the mountpoints.
4. Highlight a mountpoint.
5. Press **OK** twice to return to **Connection Settings, GS connections** page.
6. **Fn Connect** and **Fn Disconnect** are now available in all apps to connect to and disconnect from the Ntrip server.

Description

3D viewer is an interactive display feature embedded in the firmware. 3D viewer provides a graphical display of the survey elements and maps. 3D viewer allows for a better overall understanding of how the data being used and measured relates to each other. Several view modes are supported. Depending on the app, different functionality is available.



In order to view the data, it must be stored in a local coordinate system. Data in WGS 1984 only is not displayed.



If negative coordinates are used in CAD files to suit projections with the origin in North-East and the axes going South and West, use the setting **Switch Easting for CAD files** and **Switch Northing for CAD files** in **Regional, Coordinates** page to mirror the CAD file.

Terms

Term	Description
------	-------------

Split panel The panel shows 3D viewer on the right and fields on the left.



Full screen mode For the 3D viewer



For the surveying prompts area Available for Measure.

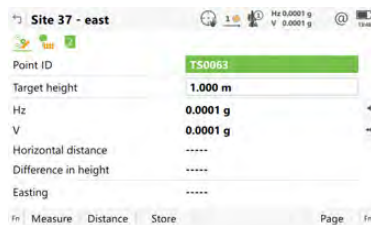

For the advanced coding area

Term	Description
------	-------------

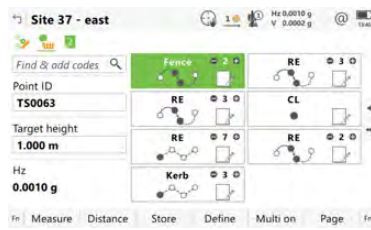

Views

View	Description
------	-------------

Camera view

A 3D perspective view of 3D data. The camera of the instrument delivers the 3D data as live video stream. The current position of the TS defines the eye point of the camera view.

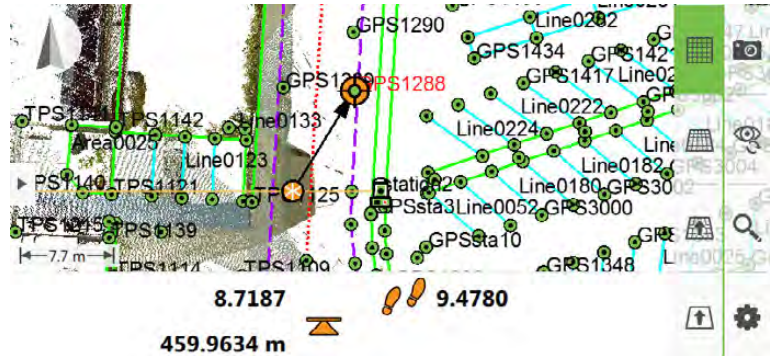

Image view

A view of images stored on the instrument. The images are captured previously. The images can have 3D data overlay. The 3D data overlay is done when taking the image. The 3D data is not live data and is not updated.



View	Description
Navigation view	<p>A 3D perspective view of 3D data.</p> <p>The navigation view shows 3D data like the orbital view. Heights are 3D.</p> <p>The navigation view guides you towards a position for staking.</p> <p>The viewing direction is set automatically by a moving measured position, to point in the direction of the movement.</p> <p>The vertical component of the viewing direction depends on the horizontal distance of the measured position to the point to be staked out.</p>



Orbital view	<p>A 3D perspective view of 3D data.</p> <p>The orbital view can be panned, zoomed and orbited.</p>
---------------------	---

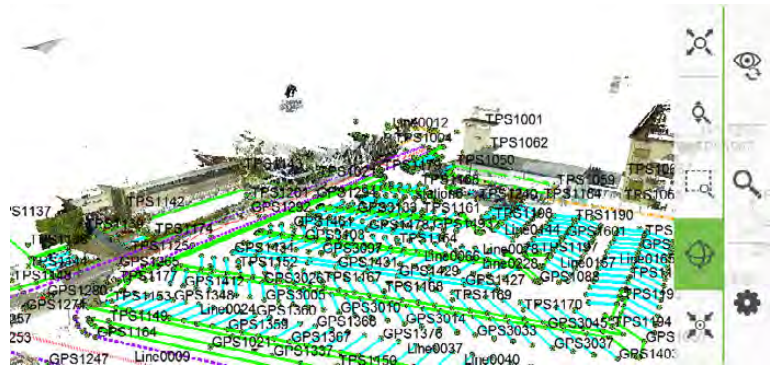

Plan view	<p>A 2D orthographic view of 2D and 3D data.</p> <p>The viewing direction is the nadir direction.</p> <p>A plan view can be panned and zoomed.</p>
------------------	--

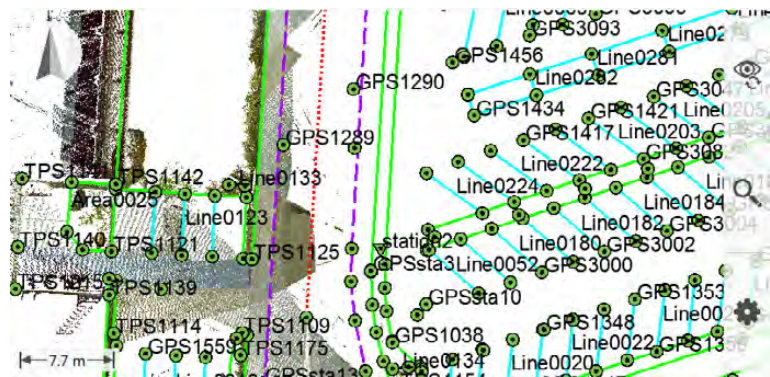

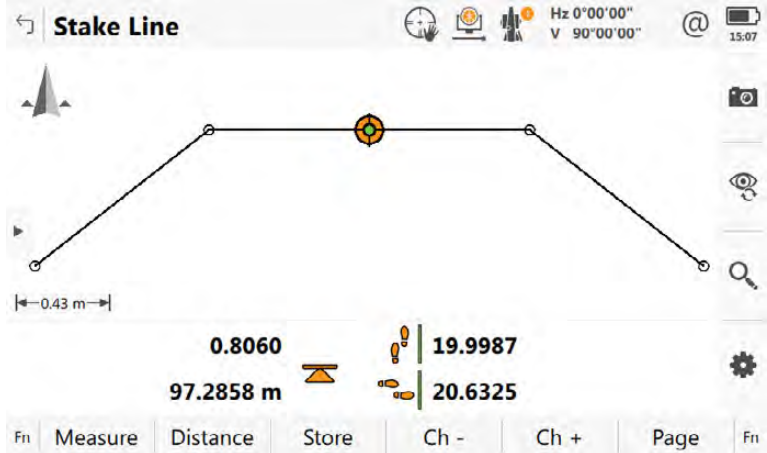
View	Description
Profile view	<p>A 2D view representing a cut or intersection with 1D, 2D or 3D data.</p> <p>Example: A long section of a road, with the height axis pointing upwards, and the axis pointing to the right representing the distance along the road.</p> <p>Example: A cross section of a road at a defined distance along the road, with the height axis pointing upwards and the axis pointing to the right representing the distance from the centreline.</p> <p>A profile view can be panned and zoomed.</p> <p>Vertical exaggerations can be adjusted in some profile views.</p> 

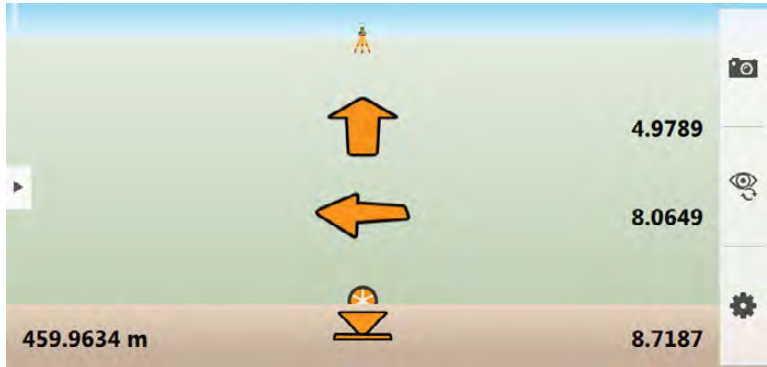
Stake view	<p>A graphical view with instructions to aid staking out points and lines. Available in Stake apps.</p> 
-------------------	--

Displayable data

The data displayed is defined by:

- the app
- filters set
- settings made for 3D viewer
- the coordinates. Position only (2D) data is automatically reduced to zero height. Height only (1D) data is not displayed.

The way the data look depends on the state.

State	Description
Normal	This is the standard state for data.

State	Description
Greyed out	This is used to distinguish non-active data. Example: If design data was selected to be used, it would be displayed greyed-out in the Measure app.
Selected	This is the state for when a selectable object is marked as selected.
In use	This is the state for when an object is used by an app and should be indicated as such. Example: The alignments used for some calculations in Road apps.

35.2

Accessing 3D viewer

Description

The 3D viewer is provided as separate feature, within all apps and in data management.

Access step-by-step

Example for Leica Captivate - Home

1. Select **Leica Captivate - Home: 3D viewer**.

Example for data management

1. Select **View & edit job properties** from the job menu.
2. **Page** until the **3D viewer** page is active.

Example for an app

1. Select **Leica Captivate - Home: Measure**.

35.3

Configuring 3D viewer

Description

Allows options to be set which are used as default. These settings are stored within the working style and apply, regardless of how 3D viewer is accessed.



Any changes made in **Object Display** affect the appearance of **3D viewer**, not just the active app.

Access step-by-step

Press **Fn Display** on any **3D viewer** panel.

Object Display, Points page

Key	Description
OK	To confirm the selections and to return to the panel from where this panel was accessed.
Page	To change to another page on this panel.

Description of fields

Field	Option	Description
Points	Check box	Determines if points are displayed.
Point IDs	Check box	Available if Points is checked. Determines if the ID of a point is displayed.

Field	Option	Description
Point codes	Check box	Available if Points is checked. Determines if the code of a point is displayed.
Height of points	Check box	Available if Points is checked. Determines if the height of a point is displayed.
Include RTK Base station within the zoom extent	Check box	The distance between the working area and the GPS base points influence the calculation of the zoom factor in 3D viewer.

When this box is checked, the GPS base points are included in the calculation of the zoom extent. The working area is displayed smaller.



When this box is not checked, the GPS base points are excluded from the calculation of the zoom factor. The working area is displayed larger.





Next step

Page changes to the **Lines & alignments** page.

Object Display,
Lines & alignments
page

Description of fields

Field	Option	Description
Lines	Check box	When this box is checked, lines from the job with 3D local grid coordinates are displayed on the view finder. Use the display of points to check completeness and reliability of the survey. Points are displayed with a visual 3D effect: Points further away from the instrument are displayed smaller than points closer to the instrument.

Field	Option	Description												
		 Points are only displayed on the image. They are not saved with the image.												
Line IDs	Check box	When this box is checked, then the line IDs are displayed with the lines.												
Alignments	Check box	When this box is checked, then the active alignment of the active Rail, Road or Tunnel job is displayed.												
Alignment ID	Check box	When this box is checked, then the line IDs for all shown alignments are displayed in.												
Lines & alignments size		Determines the thickness of selected and non-selected lines.												
		<table border="0"> <tr> <td></td> <td>Non-selected lines</td> <td>Selected lines</td> </tr> <tr> <td>3 pixels</td> <td>3 pixels</td> <td>6 pixels</td> </tr> <tr> <td>2 pixels</td> <td>2 pixels</td> <td>4 pixels</td> </tr> <tr> <td>1 pixel</td> <td>1 pixels</td> <td>3 pixels</td> </tr> </table>		Non-selected lines	Selected lines	3 pixels	3 pixels	6 pixels	2 pixels	2 pixels	4 pixels	1 pixel	1 pixels	3 pixels
	Non-selected lines	Selected lines												
3 pixels	3 pixels	6 pixels												
2 pixels	2 pixels	4 pixels												
1 pixel	1 pixels	3 pixels												
Vertical exaggeration of profiles	Editable field	<p>A scale factor to be applied over the vertical axis. A profile will be exaggerated in the vertical direction, but it will remain the same for the horizontal. The value can be between 0.1 and 50.</p> <p> This setting only has an effect in applications where cross-section views are displayed.</p>												
Display additional layers in cross section view	Check box	<p>When this box is checked, all layers of an alignment are displayed in a cross section view.</p> <p>When this box is not checked, only the active layer will be displayed.</p>												

Next step

Page changes to the **Scans** page.

Object Display, Scans page

Description of fields

Field	Option	Description
Scans	Check box	<p>Determines if point clouds from scan are displayed.</p> <p>When this box is checked, the 3D point clouds are displayed.</p>
Colour scans using		Available if Scans is ticked.

Field	Option	Description
	True colour	The point cloud is coloured according to the RGB (red, green, blue) values from the panoramic image. If a panoramic image has been taken when defining a scan, the RGB values are available.
	Intensity	The point cloud is coloured according to the intensity value of the received EDM signal.
	One colour per scan	A point cloud gets a single colour. If several scans are available, each point cloud gets a different colour. A colour table is defined in the background, from which the colours are picked for each point cloud.
Point cloud point size		Available if Scans is ticked. To change the pixel size of a single scan point displayed in the viewer. To best view the scan points in different areas.
	Small	A small point represent each scan point.
	Large	A small point represent each scan point.

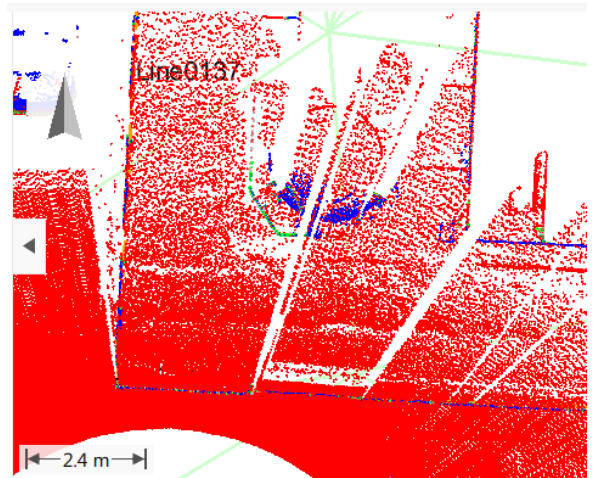

Next step

Page changes to the **DTM** page.

Object Display, DTM page

Description of fields

Field	Option	Description
DTMs	Check box	When this box is checked, DTM triangles from the active DTM or the active DTM job are displayed.
DTM colour	Selectable list	Defines the colour of the active DTM layer.

Next step

Page changes to the **Background image** page.

Object Display, Background image page

Key	Description
OK	To confirm the selections and to return to the panel from where this panel was accessed.
Images	To select the background image to be used. Opens Map images .
Page	To change to another page on this panel.

Description of fields

Field	Option	Description
Display image (press 'Images' to select which images to show)	Check box	When this box is checked, a geo-referenced background image is displayed behind the map.  At least one image file (*.jpg + *.jgw, *.archive) must have been transferred to the internal memory.

Next step

OK confirms the selections and returns to the previous panel.

Map images

Access

Press **Images** in **Object Display, Background image** page.

Key	Description
OK	To confirm the selections and to return to the panel from where this panel was accessed.
None or All	To deactivate or activate all background images.
Delete	To delete the highlighted background image.
Use	To activate and deactivate the highlighted background image.

Description of metadata

Metadata	Description
-	The name of the background image. Hierarchy of listing = hierarchy in the map: <ul style="list-style-type: none">Names alphabeticallyNumbers The file that is on top of the list is shown on the top in the map.
Size (kB)	The size of the background image in kilobytes.
Show in 3D viewer	Use background image or not. Use changes between the options.

35.4 3D viewer Components

35.4.1 Panel Area

Standard panel

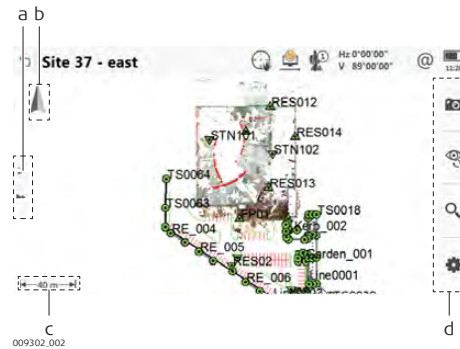

- a Split panel on/off, available in apps
- b North arrow
- c
- d Toolbar

Icon	Hardware keys	Description
	Fn +	Switches from full screen mode for 3D viewer to split panel to full screen mode for surveying prompts area or advanced coding area.
	Fn + twice	Switches directly from full screen mode for 3D viewer to full screen mode for surveying prompts area or advanced coding area.
	Fn +	Switches from full screen mode for surveying prompts area or advanced coding area to split panel to full screen mode for 3D viewer .
	Fn + twice	Switches directly from full screen mode for surveying prompts area or advanced coding area to split panel to full screen mode for 3D viewer .

35.4.2 Keys, Softkeys and Toolbar

Description

Standard functionality is provided by a toolbar and hardware keys.











Tools are available in a toolbar. The toolbar is always on the right side of the panel. Some of the functions performed by the tools can also be replicated using a hardware key. The softkey/key equivalent of each tool, if one exists, are indicated in the following table.









Tools









Tools are available in groups. The groups available depend on the active app. Click an icon to display the group of related tools.















To use the hardware keys, close the split panel so that only the 3D viewer is visible.

Icon	Hardware keys	Description
	VIEW	Access to the different available views, depending on the app. The last used view is saved. When another app is opened, the same view is used.
		Plan view. An orthometric top-down 2D view.
		Orbital view A 3D perspective view.
		Navigation view A 3D perspective view of 3D data. The navigation view guides you towards a position for staking. Only available in Stake apps.
		Stake view The stake view guides you towards a position for staking. Only available in Stake apps.
		Profile view An app-specific cross section view of a particular location along an alignment. Only available in Road apps.
		Long section view An app-specific long section view along an alignment. Only available in Road apps.
		To switch to camera view. Available when the instrument has a camera. Available only in apps.
		Camera view To switch to the telescope camera. The style of the crosshairs changes with the camera in use.
		Camera view To switch to the overview camera. The style of the crosshairs changes with the camera in use.
	NAVIGATE	For plan and orbital view, the viewing volume is stored with the job. When another app is opened, the same viewing volume is used.

Icon	Hardware keys	Description
	1	Zoom extents To fit all displayable data, according to filters and the 3D viewer settings, into the panel area, using the largest possible scale.
	2 and 3 zoom in/out in fixed steps	Zoom real-time To zoom into the data dragging the stylus in the 3D viewer area upwards to zoom in, or downwards to zoom out.
		Zoom window To zoom to a specified area window. An area window can be drawn by dragging the stylus on the panel in a diagonal line to make a rectangular area. This action causes the panel to zoom to the selected area.
		Centre to point To centre the 3D viewer on the selected point. If multiple points are selected, the last selected point using a tap is used.
	5	Centre to current position To centre the 3D viewer on the current position. Example the currently measured prism or the GS antenna.
		Orbit Available in orbital view. To orbit the data in 3D. The orbit is centred in the centre of the 3D viewer. To orbit, drag the stylus in the 3D viewer area: <ul style="list-style-type: none"> • Drag up and down to tilt the data up and down. The maximum view looking down is at the zenith, and the maximum view looking up is at the nadir. • Drag left and right to orbit the data left and right. The data is rotated around its true Z-axis. The North arrow indicates how the view was moved.
		Single autofocus To activate a single autofocus. Single autofocus deactivates continuous autofocus. Same functionality as pressing the autofocus button on the side cover of the instrument.
		Continuous focus on To switch on continuous autofocus. While continuous autofocus is active, any manually measured distance updates the focus position.

Icon	Hardware keys	Description
	2	Zoom + To zoom into the image.
	3	Zoom - To zoom out of the image.
	SET	
		<p>Selection window To select multiple objects. Points within the rectangular area are always selected. Lines are also selected, depending on the direction of the rectangular area, as detailed below.</p> <p>Drag the stylus on the panel in a diagonal line to make a rectangular area.</p> <ul style="list-style-type: none"> • Drag to the left to include all lines that pass inside the area. • Drag to the right to include only lines that are completely inside the area.
		<p>CAD layers To turn layers of background maps (CAD files) on and off. Refer to "6.2 Creating a New Job" for information on CAD files.</p>
		<p>Settings To define the display settings. Change the cross-hair colour, what is displayed in the 3D viewer, separately to the plan or orbital views.</p>
		<p>Data range To define a range from the eye point by a minimum and maximum distance. Only data within the range is displayed.</p> <p>Top slider The maximum distance from the eyepoint, for example set to 400.</p> <p>Bottom slider The minimum distance from the eyepoint, for example set to 10.</p> <p>Result Points between 10 m and 400 m from the eyepoint are displayed on the image.</p> <p> To move the slider, tap on the slider, hold and drag it.</p> <p>Switch between tap and turn and selection mode. Available in the camera view.</p>

Icon	Hardware keys	Description
		Goes to selection mode. Select data in the 3D viewer.
		Goes to tap and turn mode.
	CAMERA	Capture image To take an image with the active camera.
	BRIGHTNESS	
		Auto Bright To turn on automatic brightness.
		Bright + To increase the brightness from the current value.
		Bright - To decrease the brightness from the current value.
	SKETCH	
		Erase To remove sketched lines by moving the stylus over the area.
		On/off To activate sketching.
		Line colour To change the line colour. Tap the icon to open a window displaying line colours for selection. Move the stylus over the window to display more colours. The selected line colour is remembered.

Icon	Hardware keys	Description
		Line weight To change the line width. Tap the icon to open a window displaying line widths for selection. The selected line width is remembered.
		Text mode on/off To type text into the image. Use the keys on the keypad. Tap the screen to specify the insertion point of the text.







35.4.3





Point Symbols

Description

When **Points** is checked in **Object Display, Points** page, points are displayed according to their class.

Symbols

Symbol	Description
	Point of class Control (Ctrl) with full coordinate triplet
	Point of class Adjusted (Adj) or Average (Avge)
	Point of class Reference (Ref)
	Point of class Measured (Meas)
	Single Point Position uploaded from Infinity Point of class Navigated (Nav) or Estimated (Est)
	Point measured within a Stake app.
	Point to stakeout The position of a point or along a line to stake out.

Symbol	Description
	Current TS position
	TS target
	GS rover
	GS18 rover, tilted, quality for tilt compensation sufficient When tilt compensation is not applied, then the red arrow on top of the GS18 icon is not shown.



Points of class **None** or points of class **Control/Measured** with a height only component cannot be displayed in 3D viewer.

35.4.4

Orientation Information for Stakeout









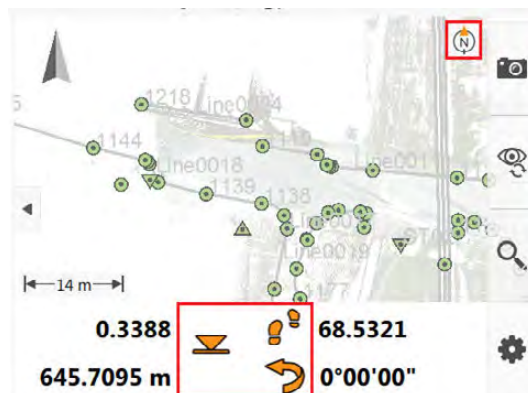









Description



In Stake views, the graphical display provides a guide to find the point to be staked out.

The settings for **Help me navigate** and **Navigational arrow types** are represented in the symbols.

Symbols



Symbol	Description
	Orientation to line.
	Orientation to North.
	Orientation to South.
	Orientation to point.
	Orientation to prism.
	Orientation to sun.
	Orientation to TS.
	Forward/backward arrow, distance to point
	Alternatively, configure the  page with Go forward/backward or Go .
	Left/right arrow, distance to point
	Alternatively, configure the  page with Go left/right .
	Turn left/right arrow, direction to point
	Alternatively, configure the  page with Turn left/right .
	Distance to point
	Cut

Symbol	Description
	Fill
	The current position and/or height is within the configured stakeout limit for position and/or height.

35.5

Selecting Points and Lines

Selecting a point/line using the touch screen step-by-step

Selecting points or lines may be required in apps, or before holding down the stylus to access the context menu to open further options.

1. Select **Leica Captivate - Home: 3D viewer**.
2. Tap on the point to be selected.

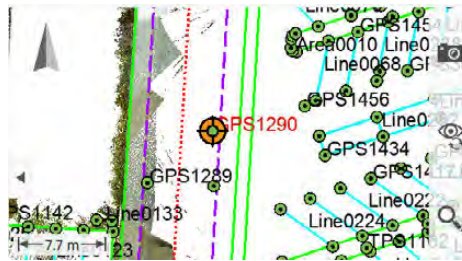

Depending on the app, one or more points or lines can be selected. Tap on the object or use the window selection to select multiple objects at the same time.

When multiple points or lines can be selected with the same tap, the selection of the objects is offered in a graphical picker. Tap on the desired point. Or tap on the background to return to the original view.

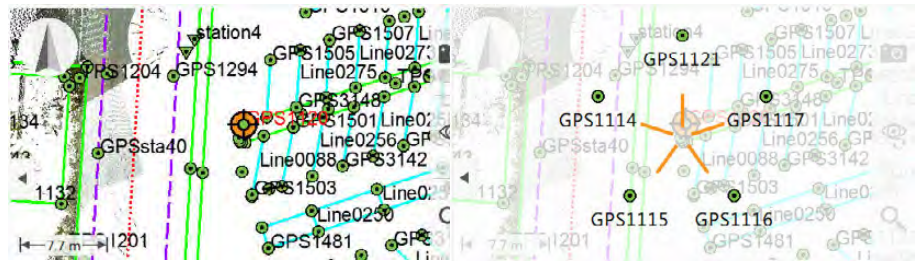

3. The point symbol of the selected point is enlarged. A selected line appears thickened.

Select a point/line without touch screen

Without touch screen or when **Use the touch screen** is not checked in **Screen, Audio & Text Input, Screen** page, points and lines can only be selected using the selectable lists.

35.6

Context Menu

Access

In **3D viewer**, hold down the stylus for 0.5 second.

Options in the context menu

The options available in the context menu depend on the objects selected or other preconditions.

Tap and hold on no object and no other object is selected

Option	Description
Create point here	Available in the 2D views. To open the New Point panel.
Turn to here	For TS. Available in the 2D views. The instrument turns to the direction of the tapped point or pixel. If Aim at target: Automatic the instrument does an ATRplus search. If Aim at target: With lock the instrument tries to lock on to a prism.

Tap and hold when one point is selected

Option	Description
Turn to here	For TS. Available in the 2D views. The instrument turns to the direction of the tapped point or pixel. If Aim at target: Automatic the instrument does an ATRplus search. If Aim at target: With lock the instrument tries to lock on to a prism.
Brng & dist from pt	To open the Bearing & Distance Input . The tapped point is displayed in the field From .
Check point	For TS. To open the Check Point panel.
Stake point	Available when a DBX or CAD point was tapped. To open the Stake points app. The tapped point is the point to be staked.
Edit point	To edit the point ID or the code.
Import	For CAD points. Imports the selected point into the DBX. The point is imported to the job the CAD is attached to. The import settings are configured in the job menu: View & edit job properties, CAD files page, Fn Settings .
Information	For CAD points. Displays the entities of the point.
Delete point(s)	To delete the tapped point.
Clear selection	To remove the highlight from all highlighted objects.

Two points selected

Option	Description
Create line	To create a line from the selected points. The points are added in the order in which they were tapped.
Calculate inverse	To open the Inverse Point to Point panel.
Import	For CAD points. Imports the selected point into the DBX. The point is imported to the job the CAD is attached to. The import settings are configured in the job menu: View & edit job properties, CAD files page, Fn Settings .
Delete object(s)	To delete the tapped points.
Clear selection	To remove the highlight from all highlighted objects.

Three points selected

Option	Description
Create line	For CAD points. To create a line from the selected points. The points are added in the order in which they were tapped.
Calculate inverse	To open the Inverse Point to Point panel.
Clear selection	To remove the highlight from all highlighted objects.
Delete object(s)	To delete the tapped points.

One line selected

Option	Description
Stake / check road	To stake/check a (local) line/(local) manual slope.
Stake / measure line	To stake/measure a line (with slope), to stake a grid from the line or to select a stake/measure task.
Edit line	To edit the line properties.
Measure line/Stake line	To measure/stake a line, segment, slope line or slope segment or to stake a grid.
Import	For CAD lines. Imports the selected line into the DBX. The line is imported to the job the CAD is attached to. The import settings are configured in the job menu: View & edit job properties, CAD files page, Fn Settings .
Information	For CAD lines. Displays the entities of the line.
View details	For Road lines. To view and edit the design data.

Option	Description
Delete line(s)	To delete the line.
Clear selection	To remove the highlight from all highlighted objects.

Several lines selected

Option	Description
Delete object(s)	To delete all highlighted objects.
Clear selection	To remove the highlight from all highlighted objects.

At least one CAD element selected

Option	Description
Hide layers	To set the status of the layer containing the CAD element to Hidden . When several CAD elements are selected and they belong to different layers, then the status of all layers is set to Hidden .

The job has a CAD file attached and at least one layer of the CAD has the status Hidden

 Layers with status **Selectable** are not affected and remain visible.

Option	Description
Show all hidden	For all layers with status Hidden : To set the status to Selectable .

Cross section view of a Road job with more than one layer

Option	Description
Set as active layer	Tapping on a grey line of an inactive layer: To change the inactive layer into the active layer.

Description

Apps are software packages supporting specific tasks. They appear in the **Leica Captivate - Home** panel as follows:

- Setup (TS)
- Scanning (MS60)
- Measure, including auto point and for GS also hidden points
- Stake points
- Stake to line
- Stake DTM
- Stake pts & DTM
- Measure to line
- QuickVolume
- Volume calc
- Traverse (TS)
- Measure sets (TS) including monitoring
- COGO
- Stake road
- Check road
- Stake rail
- Check rail
- Stake tunnel
- Check tunnel
- Create coord sys
- QuickGrid
- Meas plane/grid
- TS hidden point (TS)
- Inspect surfaces
- Customised apps

For an explanation of the apps refer to the relevant chapters.

Loadable and non-loadable apps

Type	Description
Loadable apps	<ul style="list-style-type: none"> • Can be loaded onto the instrument. • Can be deleted from the instrument.
Non-loadable app	<ul style="list-style-type: none"> • Are always available on the instrument. • Measure is a non-loadable app. To update the app, reload the system software.

Licence key

Some loadable apps are protected. They are activated through a specific licence key. Refer to "29.3 Load licence keys" for information on how to upload a licence key.

Customised apps

Customised apps can be developed locally using the GeoC++ development environment. Information on the GeoC++ development environment is available on request from the Leica Geosystems representative.

Access to an app

Select the app from the **Leica Captivate - Home** menu.

This page is common to several apps.

Description of fields

Field	Option	Description
Create report sheet	Check box	To generate a report sheet when the app is exited. A report sheet is a file to which data from an app is written to. It is generated using the selected format file.
Report sheet	Selectable list	Available when Create report sheet is ticked. The name of the file to which the data is written. A report sheet is stored in the \DATA directory of the active data storage device. The data is always appended to the file. Open the selectable list to access the Report Sheets panel. On this panel, a name for a new report sheet can be created and an existing report sheet can be selected or deleted.
Format file	Selectable list	Available when Create report sheet is ticked. A format file defines which and how data is written to a report sheet. Format files are created using Infinity. A format file must first be transferred from the data storage device to the internal memory before it can be selected. Refer to "29.1 Transfer user objects" for information on how to transfer a format file. Open the selectable list to access the Format Files panel where an existing format file can be selected or deleted.

Next step

Page changes to the first page on this panel.

Description

The toolbox contains extra functionality to those existing functions which are available using the function keys.

Frequently used functionality can be accessed quickly. The change is applied immediately. The workflow is not interrupted.

Access

Press **Fn Tools** on any page in the some apps.

OR

Press a hot key or favourites key configured to **User - App tools** on any page in the some apps.

Tools

Key	Description
OK	To apply the selected setting, or to access the selected function.

Description of options

Icon	Description
Reset backsight point	Available for the setup methods Set orientation, Known backsight, Resection and Multiple backsights . To check the backsight angle and correct the angle if necessary while working with a job. Refer to "37.2 Reset backsight point".
Check point	To check a point or the instrument orientation. Refer to "37.3 Check Point".
Measure remote points	To determine the 3D coordinates of inaccessible points. Refer to "37.4 Measure - Remote Point".
2 Store	Available for Measure distance: Once and Measure distance: Once & fast . Aim at target: Manually must be selected. To aim manually at the target and only record the angle measurement (Hz/V) in face I and face II. The point stored is an average of the two measurements.
2 Face	Available for Measure distance: Once and Measure distance: Once & fast . To take an angle and distance measurement in Face I and Face II. The point stored is an average of the two measurements. Using instruments fitted with auto aiming, the point is automatically measured in both faces. The resulting point is stored and the instrument is returned to the first face.

Icon	Description
Store code template and Load code template	Available for the Measure app. To save the current list of up to ten code boxes to a template. The template is stored to the job codelist. When storing a template, a name must be assigned. The template can be reloaded so that the current code boxes are filled in the order and with the codes including related features. Available for Coding functionality: Create linework with multicoding disabled, that is Multi on is visible on the screen.
Individual point ID and Sequential point ID	To change between entering an individual point ID different to the defined ID template and the running point ID according to the ID template. Refer to "26.3 ID templates".
Measure hidden point	To measure points which cannot be measured directly by GNSS, because, either they cannot be physically reached, or because satellites are obstructed, for example by trees or tall buildings. Refer to "37.5 Measure - Hidden Points".
Select next nearest point	For GS Stakeout: To search the design job for the point nearest to the current position. The point is selected as the point to be staked and is displayed in the first field on the panel. After staking and storing the nearest point, the next point suggested for staking out is the one which was suggested before the key was pressed.  Assign the function GS - Select next nearest point to the favourites or a hot key. Refer to "2.2.1 Hot Keys" for information on hot keys.
Turn TS to point in 2D	For TS Stakeout: To position the telescope (X,Y) onto the point to be staked.
Turn TS to point in 3D	For TS Stakeout: To position the telescope (X,Y,Z) onto the point to be staked.
Manual enter Hz & distance	For TS Stakeout: To enter angle and distance values to stake out a point.
Export cut sheet	For TS Stakeout: To export a stake report showing the differences between the staked points and the design points.
Closest point	To select the point closest to the point which was measured.
Measure Foresight	Provides points calculated from averaged backsight-foresight sets from the setup position.

37.2

Reset backsight point

Description

This feature is available in TS mode.

Available for the setup methods **Set orientation**, **Known backsight**, **Resection** and **Multiple backsights**.

Usage

- Checking the direction to the backsight point
- Correcting the angle if necessary while working

Reset backsight point

The behaviour of the tool depends on the settings of the current setup.

For measurements to a prism:

- The settings are recalled.
- The instrument turns to the angle with which the (first) backsight point was measured, searches the prism and measures to the prism.
- The instrument measures a distance.
- The differences in angle, horizontal distance and height between the measurements and the original measurements are displayed.

For measurements to any surface (reflectorless):

- The settings are recalled.
- The instrument turns to the angle with which the (first) backsight point was measured.
- The telescope can be manually be turned to the exact backsight direction.
- The difference in horizontal angle is shown.

Key	Description
Reset Ang	To set the measured horizontal angle of the checked backsight point back to what it has been during the original setup and to store the new measurement as a new setup record (Set orientation). All future measurements will refer to the new setup.
Distance	To measure a distance. The angle and distance fields are updated.
Cancel	To continue with the current setup.

Description of fields

Field	Option	Description
Point ID	Display only	Point ID of the backsight point.
Target height	Editable field	Height of the target above or below the backsight point.
Target	Selectable list	Last configured target type the backsight point was measured with as stored in the settings.

Field	Option	Description
Difference in azimuth	Display only	The difference in horizontal angle between the setup point and the backsight point.
Difference in horizontal distance	Display only	The difference between the calculated horizontal distance from setup to backsight point and the measured horizontal distance.
Difference in height	Display only	The vertical distance between the setup point and the backsight point.

37.3

Check Point

Description

This panel is used to check if a measured point is identical to a point already stored in the job, or if the orientation of the instrument to a backsight point is still correct.

Check Point

Check Point Hz 41.3179 g V 0.0003 g 15:50

Point ID: TS0002

Target height: 0.000 m

Target: Any surface

Difference in azimuth: -----

Difference in horizontal distance: -----

Difference in height: -----

Choose the point to be checked. Press 'Store' to store the measurement.

Back Distance Store Turn to More Last

Key	Description
Back	To return to the app.
Distance	To measure a distance.
Store	To store the result of the point check. The result can be exported as part of the current job.
Turn to	To position to the selected point. For Aim at target: Automatic the instrument does an ATR-plus search. For Aim at target: Lock the instrument tries to lock on to a prism.
More	To display additional information.
Last	To recall the point ID of the last checked point.

Description of fields

Field	Option	Description
Point ID	Selectable list	Point ID to be checked. If a stored point was checked, the point ID for that point is remembered and recalled when Last is pressed.
Target height	Editable field	The last used prism height is suggested. An individual prism height can be typed in.
Target	Selectable list	Target names as configured in the Targets panel.

Field	Option	Description
Difference in azimuth	Display only	Difference between calculated azimuth and current orientation.
Difference in horizontal distance	Display only	Difference between calculated and current distance. Displayed after a distance was measured with Distance .
Difference in height	Display only	Difference between calculated and current height. Displayed after a distance was measured with Distance .
Current azimuth	Display only	Current orientation.
Horizontal distance	Display only	Current distance between setup and backsight point. Displayed after a distance was measured with Distance .
Difference in height	Display only	Current height difference between setup and backsight point. Displayed after a distance was measured with Distance .
Calculated azimuth	Display only	Calculated azimuth between setup and backsight point.
Calculated horizontal distance	Display only	Calculated horizontal distance between setup and backsight point.
Calculated difference in height	Display only	Calculated height difference between setup and backsight point.

37.4

Measure - Remote Point

37.4.1

Overview

Description

Remote point is used to determine the 3D coordinates of inaccessible points, for example on bridges. The horizontal distance to a base point directly underneath or above the remote point is measured. Then the instrument is aimed at the remote point. The coordinates of the remote point are calculated with the distance measured to the base point and the angles measured to the remote point.

Diagram

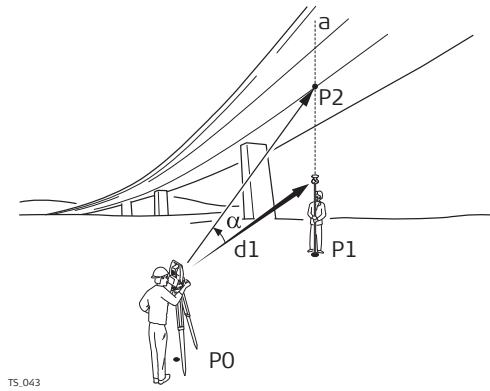

- P0 Instrument setup
- P1 Base point
- P2 Remote point
- d1 Horizontal distance to the base point
- α Vertical angle between base point and remote point
- a Vertical axis from P1 to P2

T5_043



To ensure correct results, the remote point and the prism must be lined up vertically. If it is not possible to maintain an exactly vertical line, the acceptable **Horizontal distance tolerance** must be chosen. The horizontal distance to the remote point and to the base point should coincide.

Averaging of remote points

An average can be calculated for remote points if a measured point of class **Measured** already exists with the same point ID. The average flag for the point is **Auto**.

Coding of remote points

Type	Description
Point coding	Available in Remote points .
Free coding	Free coding of remote points is identical to coding of manually measured points.
Quick coding	Not available.

37.4.2

Accessing Remote Point

Description

Select **Measure remote points** from the toolbox. A valid distance measurement must be available.

Measure Remote Point, Remote points page

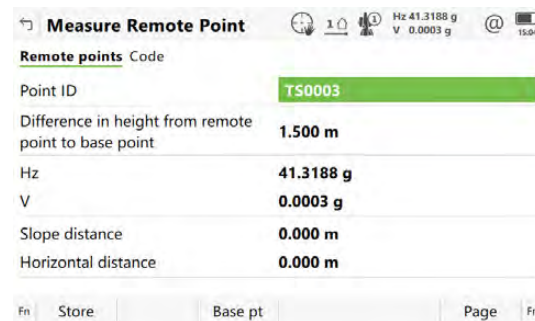

Key	Description
Store	Stores the remote point. Stays in this panel.
Base pt	Returns to Measure . The distance measurement is cleared.
Fn Settings	To configure hidden point measurements. Refer to "37.4.3 Configuring Remote Point".

Key	Description
Fn Individ ID Fn Run	To change between entering an individual point ID different to the defined ID template and the running point ID according to the ID template. Refer to "26.3 ID templates".

Description of fields

Field	Option	Description
Point ID	Editable field	Displays the point ID for the remote point. The point ID in Measure Remote Point is always identical to the point ID in Measure .
Difference in height from remote point to base point	Display only	The elevation difference between the base point and the remote point.
Hz	Display only	The current horizontal angle.
V	Display only	The current vertical angle.
Slope distance	Display only	The current slope distance to the remote point calculated from the horizontal distance to the base point and the current vertical angle.
Horizontal distance	Display only	The horizontal distance measured to the base point.
Easting	Display only	Calculated Easting coordinate for the remote point.
Northing	Display only	Calculated Northing coordinate for the remote point.
Height	Display only	Calculated height for the remote point.

Next step

IF	THEN
a remote point must be stored	Store.
a new base point must be measured	Base pt to return to the Measure app.
a code must be added	change to the Code page.

37.4.3

Configuring Remote Point

Access

In **Remote points** press **Fn Settings** to access **Remote points**.

Measure Remote Point

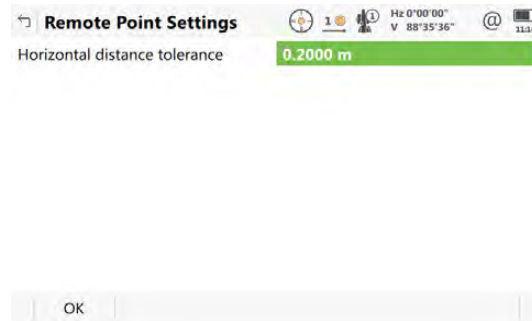

Key	Description
OK	To accept changes and return to the panel from where this panel was accessed.

Description of fields

Field	Option	Description
Horizontal distance tolerance	Editable field	The horizontal distance to the remote point is equal to the horizontal distance of the base point. The value is the maximum tolerated length of the chord between the base point and the remote point.

37.5

Measure - Hidden Points

37.5.1

Overview

Description

This feature is available in GS mode. It allows measuring points that cannot be directly accessed with the GS. For instance, if a point physically cannot be reached or because no satellites can be tracked in the point to be measured due to obstructions.

- A hidden point can be calculated by measuring distances and/or azimuths to the hidden point using a hidden point measurement device. Or for distances a tape can be used.
- Extra auxiliary points can be manually measured.
- Bearings can be computed from previously measured points.

In contrast to the COGO app, hidden point measurements are more of a measuring app than a calculation app.

Example

Application:

Completing a survey of telegraph poles for a telecommunication company.

Aim:

The telegraph poles must be surveyed to 0.3 m accuracy in plan but height is not of concern.

Use of hidden point measurements:

For poles surrounded by heavy undergrowth, where it is not possible to measure the pole directly without taking time to cut a path through the undergrowth.



Changing coordinates of a point which has been previously used in hidden point measurements does not result in the hidden point being recomputed.

Hidden point measurement methods

A hidden point can be measured by

- Bearing and distance
- Two bearings
- Two distances
- Chainage and offset
- Backwards bearing and distance



A hidden point measurement device can be attached to the instrument such that the measurements are automatically transferred to the instrument.

Heights

If configured, heights are taken into account. Refer to "37.5.8 Hidden Point Measurement Including Heights" for information on configuring height offsets.

Device height and **Target height** configured in **Hidden Point Settings** are applied when the hidden points are computed. **Difference in height in Measure Hidden Point** is the value directly from the hidden point measuring device.

Coding of hidden points

Type	Description
Point coding	Available in Hidden Point Result after the calculation of a hidden point.
Free coding	Free coding of hidden points is identical to coding of manually measured points.
Quick coding	Not available.



Azimuth is used throughout this chapter. This term should also always be considered to mean **Bearing**.

Auxiliary points

Auxiliary points are used to compute azimuths required for the calculation of hidden point coordinates. Auxiliary points can be points existing in the job or they can be manually measured. The point ID template configured for **Auxiliary points** in **ID Templates** is applied.

37.5.2

Hidden Point Methods

Bearing & Distance

Description

One point must be known. It

- can exist in the job.
- can be manually measured during the hidden point measurements.
- can be manually typed in.

The distance and the bearing from the known point to the hidden point are to be determined. An auxiliary point helps compute the bearing which might not be known. The auxiliary point can be determined in the direction from the known point to the hidden point.

Diagram

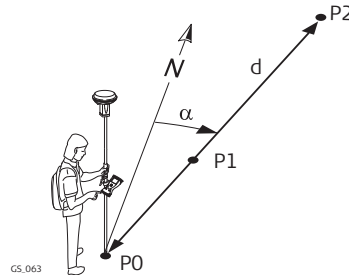

Known

P0 Known point

To be measured

d Distance from P0 to P2

α Bearing from P0 to P2

P1 Auxiliary point, optional

Unknown

P2 Hidden point

Using two bearings

Description

Two points must be known. They

- can exist in the job.
- can be manually measured during the hidden point measurements.
- can be manually typed in.

The bearings from the known points to the hidden point are to be determined. Auxiliary points help compute the bearings which might not be known. Auxiliary points can be measured in the direction from the known points to the hidden point.

Diagram

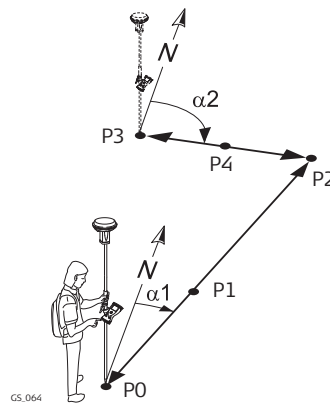

Known

P0 First known point

P3 Second known point

To be measured

α_1 Bearing from P0 to P2

α_2 Bearing from P3 to P2

P1 First auxiliary point, optional

P4 Second auxiliary point, optional

Unknown

P2 Hidden point

Using two distances

Description

Two points must be known. They

- can exist in the job.
- can be manually measured during the hidden point measurements.
- can be manually typed in.

The distances from the known points to the hidden points are to be determined. The location of the hidden point relative to the line between the two known points is to be defined.

Diagram

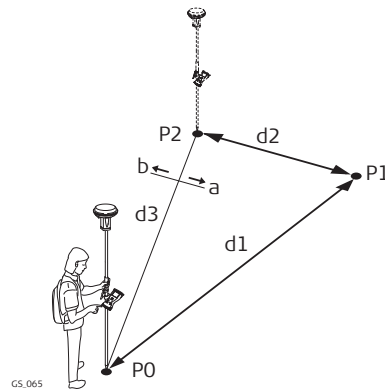

Known

- P0 First known point
- P2 Second known point
- d3 Line from P0 to P2
- a Right of d3
- b Left of d3

To be measured

- d1 Distance from P0 to P1
- d2 Distance from P2 to P1

Unknown

- P1 Hidden point

Chainage & offset

Description

Two points must be known. They

- can exist in the job.
- can be manually measured during the hidden point measurements.
- can be manually typed in.

The chainage from one known point along the line between the two known points must be determined. The offset of the hidden point to the line between the two known points must be determined.

Diagram

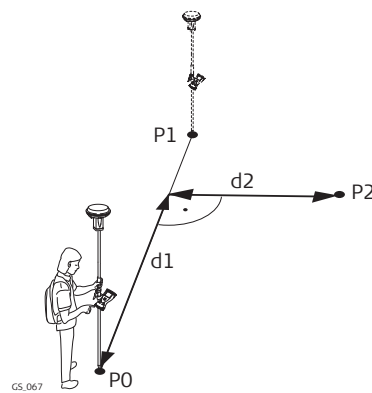

Known

- P0 First known point
- P1 Second known point

To be measured

- d1 Chainage
- d2 Offset

Unknown

- P2 Hidden point

Backwards bearing & distance

Description

In order to compute the hidden point, the measurements are taken from the hidden point.

One point must be known. It

- can exist in the job.
- can be manually measured during the hidden point measurements.
- can be manually typed in.

The distance and the bearing from the hidden point to the known point are to be determined. An auxiliary point helps compute the bearing which might not be known. An auxiliary point can be measured in the direction from the hidden point to the known point.

Diagram

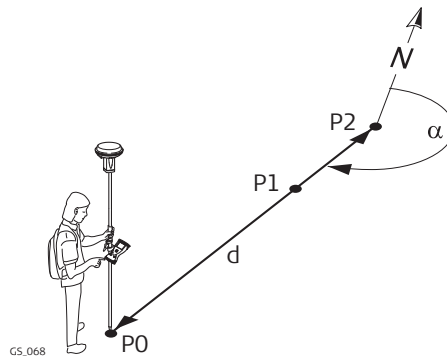

Known

P0 Known point

To be measured

α Bearing from P2 to P0

d Distance from P2 to P0

P1 Auxiliary point, optional

Unknown

P2 Hidden point

37.5.3

Hidden Point Settings, General page

Hidden Point Settings

Key	Description
OK	To accept changes and return to the panel from where this panel was accessed.
Search	Available when a Bluetooth port and device is selected. To search for all available Bluetooth devices. If more than one Bluetooth device is found a list of available devices is provided.
Device	To create, select, edit or delete a device.
Page	To change to another page on this panel.

Description of fields

Field	Option	Description
Use a device to measure hidden points	Check box	To compute a hidden point with height. Activates the hidden point connection. If not checked, the measured values must be entered manually.
Connect using	CS Bluetooth 1 and CS Bluetooth 2	The Bluetooth ports on the field controller which are used for the connection functionality.
	CS RS232 port	The RS232 port on the field controller.
	Internal Disto	The DISTO in the CS20.

Field	Option	Description
Device	Display only	The name of the selected hidden point device.

Measure distance from

Front of CS20

Available for **Device: Internal Disto**. The settings define the offsets applied to the measurements.

The CS20 is placed to with its front to an object to measure the distance.



Back of CS20

The CS20 is placed to with its back to an object to measure the distance.

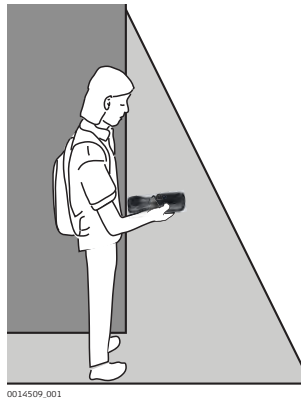

Front of pole



Right-handed setup:



a Pole
b Clamp

Back of pole

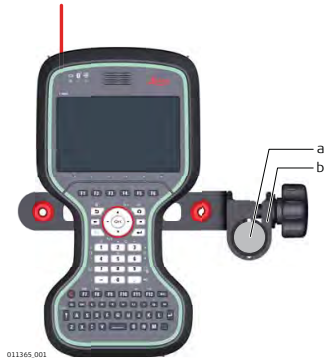
Right-handed setup:

Field	Option	Description
		 <p style="text-align: right;">a Pole b Clamp</p>
Left-handed setup	Check box	<p>Available for Measure distance from: Front of pole and Measure distance from: Back of pole.</p> <p>The settings define the offsets applied to the measurements.</p> <p>Front of CS20, left-handed setup:</p>  <p style="text-align: right;">a Pole b Clamp</p> <p>Back of CS20, left-handed setup:</p>  <p style="text-align: right;">a Pole b Clamp</p>
Bluetooth ID	Display only	Available if CS Bluetooth 1 or CS Bluetooth 2 are selected. The Bluetooth ID of the hidden point device.
Measure azimuth using CS20 compass	Check box	Use the compass in the CS20.

Next step

Page changes to the **Height & offsets** page.

Hidden Point Settings, Height & offsets page

Key	Description
OK	To accept changes and to return to Measure Hidden Point .
Page	To change to another page on this panel.

Description of fields

Field	Option	Description
Compute height for hidden points	Check box	When this box is checked, heights are computed for hidden points.
Use distance offset	Check box	When this box is checked, a defined distance offset is added to the measured distance.
Offset	Editable field	Available when Use distance offset is checked. The distance offset is automatically added to the measured distance.
Use angle offset	Check box	When this box is checked, a defined angle offset is added. The offset is an angle between the North of the device being used and WGS1984 geodetic North. The offset is applied when measuring hidden points using a device capable of measuring azimuths. When this box is not checked, no angle offset is applied to the azimuth measurement received from the hidden point measurement device.
Type		Sets the default method for entering an angle offset. Permanent Applies a default value for the offset angle. The value is changeable. New for each point Offset angle values must be entered for each new hidden point.
Angle offset	Editable field	The default value for the offset angle.
Use height offset	Check box	When this box is checked, a defined height offset is added to the measured. When this box is not checked, no height offsets are used. The result is the delta height between the centre of the device and the aimed point.
Type		Available when Use height offset is checked.

Field	Option	Description
	Device height	When measuring hidden points, the height of the hidden point measurement device can be typed in. This option should be used when the hidden point can be directly measured using the hidden point device.
	Device & target ht	When measuring hidden points, the height of the hidden point measurement device as well as the target height can be typed in. Use this option when the hidden point cannot be directly measured with a hidden point device, but a target point can be used to calculate the position.
Device height	Editable field	The height of the hidden point measurement device. This height is the distance from the ground to the centre of the device.
Target height	Editable field	The distance from the hidden point to the aimed point.

Next step

Page changes to the **Measurement quality** page.

Hidden Point Settings,
Measurement quality
page

Key	Description
OK	To accept changes and to return to Measure Hidden Point .
Page	To change to another page on this panel.

Description of fields

Field	Option	Description
2D quality	Editable field	Define a distance and height quality
1D quality	Editable field	Define a distance quality

37.5.4

Hidden Point Measurements



Hidden point measurements are possible from the Measure app and when the Measure app is called from another app.

Access

Press **Measure hidden point** in the toolbox of the **Measure** app.

Measure Hidden Point,
Hidden point page

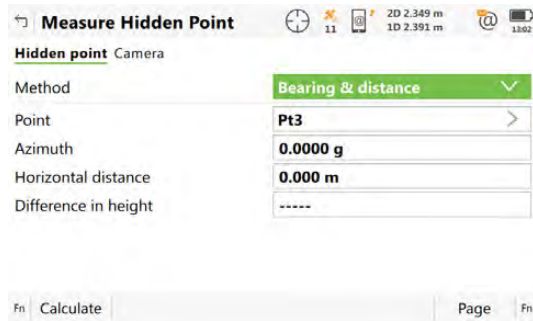

The setting for **Method** on this panel determines the availability of the subsequent fields and softkeys.



Key	Description
Calculate	To calculate the hidden point and to display the results.
Ang Offset	To change or enter an External Angle Offset . Available when Compute height for hidden points and Use height offset is checked in Hidden Point Settings, Height & offsets page.
Heights	To type in the device and target heights to be considered. Available when Compute height for hidden points and Use angle offset is checked in Hidden Point Settings, Height & offsets page.
Sun	Available when Azimuth is highlighted. The azimuth from the direction of the sun to the known point is computed.
Azimuth	Available when Azimuth is highlighted. To select or manually measure an auxiliary point and to compute the azimuth.
Dist along	To determine chainage and offset of the current position relative to the line between the two known points. The values are displayed in Distance along and Offset . The point from where the chainage has been measured is selected in Start point .
Slope	Available when Horizontal distance is highlighted. To measure a slope distance and an elevation angle or percentage grade. The values are used to compute the horizontal distance.
Meas app	Available when a point field is highlighted. To measure the known point manually for the calculation of the hidden point.
Fn Settings	To configure hidden point measurements. Refer to "37.5.3 Hidden Point Settings".

Description of fields

Field	Option	Description
Method	Selectable list	The method for measuring hidden points. Refer to "37.5.2 Hidden Point Methods" for a description of the methods.

Field	Option	Description
Point	Selectable list	The point ID of the current position. This point is the known point for the calculation of the hidden point.  To type in coordinates manually for the known point open the selectable list and create a point.
Point A	Selectable list	The point ID of the current position. This point is the first known point for the calculation of the hidden point.  To type in coordinates manually for the known point open the selectable list and create a point.
Point B	Selectable list	The point ID of the current position. This point is the second known point for the calculation of the hidden point.  To type in coordinates manually for the known point open the selectable list and create a point.
Azimuth	Editable field	The azimuth from the known point to the hidden point. Type in an azimuth. When a hidden point measurement device is attached to the instrument to measure the azimuth, the value is automatically transferred.
Horizontal distance	Editable field	The horizontal distance from the known point to the hidden point. Type in a distance. When a hidden point measurement device is attached to the instrument to measure the distance, the value is automatically transferred.
Side of line	Selectable list	Available for Method:Using 2 distances . The location of the hidden point relative to the line from Point A to Point B .
Start point	Selectable list	Available for Method:Distance & offset . The chainage from one known point along the line between the two known points. Looking from the point selected in Start point , a positive chainage is towards the second known point. A negative chainage is into the opposite direction of the second known point.

Next step

Calculate calculates the hidden point and displays the results in **Hidden Point Result**.

Computed distances on Hidden Point Result

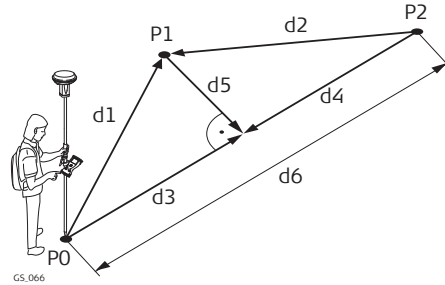

- P0 First known point
- P1 Hidden point
- P2 Second known point
- d1 Distance from P0 to P1
- d2 Distance from P2 to P1
- d3 **Distance from A**
- d4 **Distance from B**
- d5 **Offset**
- d6 **Distance between A & B**

Hidden Point Result

Key	Description
Store	To store the result.
Page	To change to another page on this panel.
Next	To store the hidden point and to return to Measure Hidden Point . Another hidden point can be measured.
Fn Indiv ID Fn Run	To change between entering an individual point ID different to the defined ID template and the running point ID according to the ID template.

Description of fields

Field	Option	Description
Point ID	Editable field	The identifier for the hidden point. The configured point ID template is used. The ID can be changed. Type in a point ID.
Distance between A & B	Display only	Available for Method:Using 2 bearings and Method:Using 2 distances . The computed horizontal distance between Point A and Point B .
Bearing between A & B	Display only	Available for Method:Using 2 bearings and Method:Distance & offset . The computed bearing from Point A to Point B .
Distance to A	Display only	Available for Method:Using 2 bearings and Method:Using 2 bearings . The computed horizontal distance between Point A and the hidden point.
Distance to B	Display only	Available for Method:Using 2 bearings and Method:Distance & offset . The computed horizontal distance between Point B and the hidden point.
Distance from A	Display only	Available for Method:Using 2 distances . The computed distance on the line from Point A to Point B from Point A to the point of intersection with Offset .
Distance from B	Display only	Available for Method:Using 2 distances . The computed distance on the line from Point B to Point A from Point B to the point of intersection with Offset .

Field	Option	Description
Offset	Display only	Available for Method:Using 2 distances . The computed perpendicular distance from the hidden point to the line from Point A to Point B .

Next step

On the **Code** page, type in a code if desired.

37.5.6

Computing an Azimuth

Using the sun

Description

The azimuth for a hidden point measurement can be computed using a known point and the sun. The known point can be manually measured. The location of the hidden point can be away from the sun or in the direction towards the sun. Ensure that the shadow of the pole falls in the direction of the point.

Diagram

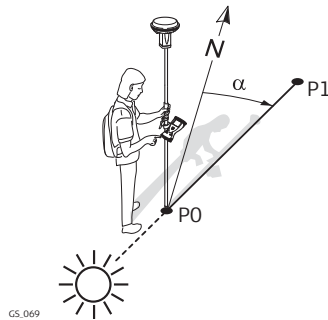

P0 Known point
P1 Hidden point
 α Bearing from P0 to P1

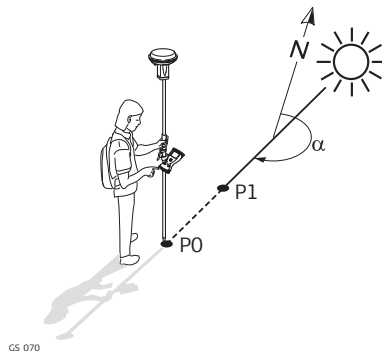

P0 Known point
P1 Hidden point
 α Bearing from P0 to P1

Requirements

Bearing & distance, Using 2 bearings or **Back bearing & distance** must be selected for **Method**.

Access

In **Measure Hidden Point** highlight **Azimuth**. Press **Sun**.

Follow the instructions on the panel.

Using azimuth point

Description

The azimuth for a hidden point measurement can be computed using an auxiliary point. The auxiliary point

- can exist in the job.
- can be manually measured during the hidden point measurements.
- can be manually typed in.

The location of the auxiliary point can be in the direction towards the hidden point or away from the hidden point.

Diagram

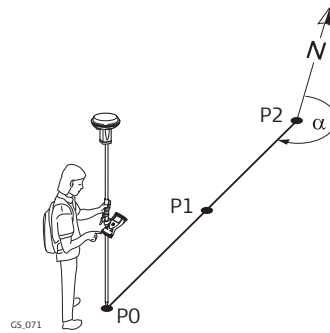

- P0 Known point
- P1 Auxiliary point, **Azimuth Pt**
- P2 Hidden point
- α Bearing from P2 to P0

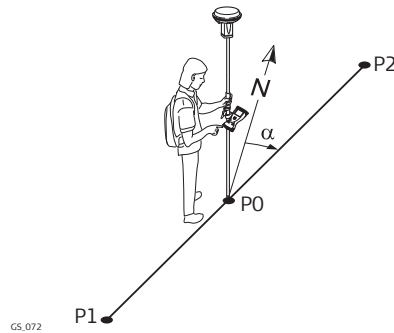

- P0 Known point
- P1 Auxiliary point, **Azimuth Pt**
- P2 Hidden point
- α Bearing from P0 to P2

Requirements

Bearing & distance, Using 2 bearings or **Back bearing & distance** must be selected for **Method**.

Access

In **Measure Hidden Point** highlight **Azimuth**. Press **Azimuth**.

Choose Azimuth Point

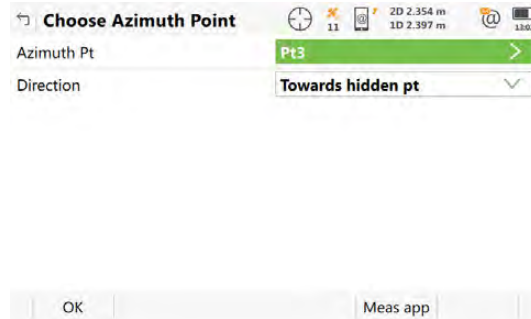

Key	Description
OK	To accept changes and return to the panel from where this panel was accessed. The azimuth is computed and displayed in Azimuth in Measure Hidden Point .
Meas app	Available for Azimuth Pt being highlighted. To measure the auxiliary point manually for the calculation of the azimuth.

Description of fields

Field	Option	Description
Azimuth Pt	Selectable list	The auxiliary point for the calculation of the azimuth.
Direction	Selectable list	The location of the auxiliary point relative to the hidden point.

Next step

OK closes the panel.

37.5.7

Computing Horizontal Distances from Slope Distances

Description

The horizontal distance for a hidden point measurement can be computed using a slope distance, and an elevation angle or percentage grade. The slope distance and the elevation angle can either be typed in or measured with a hidden point measurement device.

Diagram

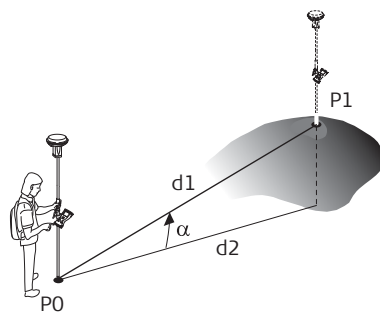

GS_073

- P0 Known point
- P1 Hidden point
- d1 Slope distance
- d2 Horizontal distance
- α Elevation angle

Requirements

Bearing & distance, Using 2 bearings or **Back bearing & distance** must be selected for **Method**.

Access

In **Measure Hidden Point** highlight **Horizontal distance**. Press **Slope**.

Slope Distance

Slope Distance

Slope distance	5.850 m
Elevation angle	25.0000 g
Grade (%)	41.4 %
Horizontal distance	5.405 m
Difference in height	2.239 m

OK

Key	Description
OK	To take over the result.

Description of fields

Field	Option	Description
Slope distance	Editable field	Type in a distance from the known point to the hidden point. When a hidden point measurement device is attached to the instrument to measure the distance, the value is automatically transferred.
Elevation angle	Editable field	Type in the elevation angle from the known point to the hidden point. When a hidden point measurement device is attached to the instrument to measure the elevation angle, the value is automatically transferred.
Grade (%)	Editable field	The grade from the known point to the hidden point is automatically computed from the slope distance and the elevation angle.  The value for Grade (%) can be typed in instead of the value for Elevation angle . Then Elevation angle is computed automatically.
Horizontal distance	Display only	The horizontal distance from the known point to the hidden point is automatically computed from the slope distance and the elevation angle.
Difference in height	Display only	The height difference between the known point and the hidden point is automatically computed from the slope distance and the elevation angle. Available if Compute height for hidden points is checked in Hidden Point Settings, Height & offsets page.

Next step

OK returns to **Measure Hidden Point**. The horizontal distance is displayed in **Horizontal distance**.

37.5.8

Hidden Point Measurement Including Heights

Diagram

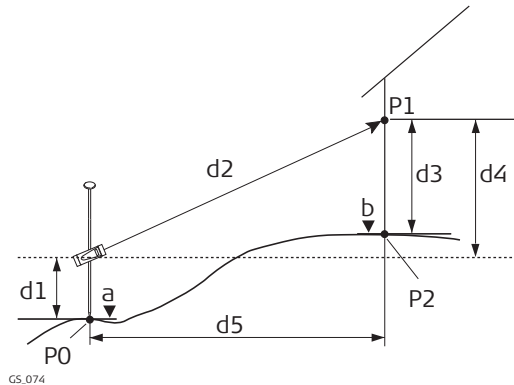

- P0 Known point
- P1 Target point
- P2 Hidden point
- a Height of P0
- b Height of P2 = $a + d1 + d4 - d3$
- d1 Device height: Height of hidden point measurement device above P0
- d2 Slope distance
- d3 Target height: Height of P1 above P2
- d4 Height difference between hidden point measurement device and P1
- d5 Horizontal distance

Configuration

Check **Compute height for hidden points** and **Use height offset** in **Hidden Point Settings, Height & offsets** page.

Measure Hidden Point

Description of fields

Field	Option	Description
Difference in height	Selectable list	<p>The positive or negative height difference between the centre of the hidden point measurement device and the target point. Type in the value. When a hidden point measurement device is attached to the instrument to measure the height difference, the value is automatically transferred.</p> <p> For hidden point measurement methods using two known points, Difference in height must be determined from each known point.</p> <p>Refer to "37.5.4 Hidden Point Measurements" for a description of all other fields on the panel.</p>

Next step

Press **Heights**.



The **Heights** key is only available if **Compute height for hidden points** and **Use height offset** are checked in **Hidden Point Settings, Height & offsets** page.

Device & Target Height

Description of fields

Field	Option	Description
Device height at point A	Editable field	The height of the hidden point measurement device above Point A .
Target height	Editable field	The height of the target point above the hidden point when measured from Point A .
Device height at point B	Editable field	Available for hidden point measurement methods using two known points. The height of the hidden point measurement device above Point B .
Target height	Editable field	Available for hidden point measurement methods using two known points. The height of the target point above the hidden point when measured from Point B .

Next step

OK closes the screen and returns to **Measure Hidden Point**.

There, **Difference in height** still displays the positive or negative height difference between the centre of the hidden point measurement device and the target point. The heights of the hidden point measurement device above the ground, and the target point above the hidden point, are applied when the hidden point is computed. For hidden point measurement methods using two known points, this computation is done for each known point. In this case, the height of the hidden point is the average.

37.6

Measure Foresight

Description

Measure foresight provides points calculated from averaged backsight-foresight sets from the setup position.

Measure foresight includes:

- Collecting, reviewing and editing sets
- Classifying the resulting foresight points independently from other points
- Exporting the raw observations in order to process the data in the office.



Measure foresight cannot be used when the setup was done using the setup method **Orientate to object**.

Access

Select **Measure foresight** in the toolbox.

**Measure Foresight,
Automation behav-
iour page**

Key	Description
OK	To accept changes and continue to the next panel.
Page	To change to another page on this panel.

Description of fields

Field	Option	Description
Measure- ment sequence	B'F'...F''B''	All points are measured in face I, then measured in face II in reverse sequential order.
	B'F'...B''F''	All points are measured in face I, then measured in face II.
	B'B''F'F''...	Backsight point is measured in face I immediately followed by face II. Other points are measured in face I, face II order.
	B'B''F''F'...	Backsight point is measured in face I immediately followed by face II. Other points are measured in alternating face order.
	B'F'...	All points are measured in face I only.
When using auto target aiming, automatically measure targets	Check box	For instruments with automatic aiming and this option checked, automatic aiming search and automatic aiming measurements are done to specified targets and subsequent sets.

Next step

Page changes to the **Quality control** page.

**Measure Foresight,
Quality control page**

Description of fields

Field	Option	Description
Check for errors before storing	Check box	The entered horizontal, vertical and distance tolerances are checked during the measurements to verify accurate pointing and measurements.
H_z tolerance	Editable field	Tolerance for horizontal directions.
V tolerance	Editable field	Tolerance for vertical directions.
Distance tolerance	Editable field	Tolerance for distance.
Check the backsight height	Check box	The entered height tolerance for the backsight point is checked during the measurements to verify accurate pointing and measurements.
Height limit	Editable field	Tolerance for the backsight height.

Next step

OK changes to **Set Backsight Reference**.

Set Backsight Reference

Available when the instrument was set up using **Setup method: Known backsight**.

Set the backsight to which the angles of the foresight measurements are related.

The current setup is used.

Description of fields

Field	Option	Description
Use the current backsight as the reference point	Option button	Available when the instrument was set up using Setup method: Known backsight . The backsight from the current setup is used. Foresight measurement is referenced to the backsight.
Set another backsight as reference point (the current setup will be updated)	Option button	Available when the instrument was set up using Setup method: Known backsight . The backsight from the current setup is ignored. A new backsight must be defined.

Next step

IF	THEN
Use the current backsight as the reference point was selected	OK to measure backsight-foresight sets.
Set another backsight as reference point (the current setup will be updated) was selected	OK accesses Define the Backsight . Refer to "Define the Backsight".

Define the Backsight

This panel is displayed

- when the instrument was set up without a known backsight. The instrument is orientated but has no physical point as a backsight. Therefore a backsight point must be measured.
- when **Set another backsight as reference point (the current setup will be updated)** was previously selected.

Key	Description
Set	To set the setup and orientation.
Distance	To measure a distance to the point being used to set the azimuth.
GS	When using SmartPole. To enter the Measure panel and measure a point with GS. The antenna height is automatically converted from the target height.
More	To change between the slope and the horizontal distance.

Key	Description
Page	To change to another page on this panel.

Description of fields

Field	Option	Description
Backsight ID	Editable field	Point ID of the backsight point.
Target height	Editable field	Height of the target above or below the backsight point. The last setup target height is always remembered.
Computed direction	Display only	Displays the calculated azimuth from the selected setup to the backsight point.
Computed horizontal distance	Display only	Displays the calculated horizontal distance between the selected setup and backsight point.
Difference in horizontal distance	Display only	The difference between the calculated horizontal distance from setup to backsight point and the measured horizontal distance.
Computed slope dist	Display only	Displayed after More was pressed. The calculated slope distance to the backsight point.
Difference in slope distance	Display only	Displayed after More was pressed. The difference between the calculated slope distance from setup to backsight point and the measured slope distance.
Difference in height	Display only	The difference between the design height of the backsight point and the measured height of the backsight point. If the backsight point is a 2D point, this field shows -----.

Next step

Set starts backsight-foresight set measurements.

Foresight

Key	Description
Measure	To measure and record the foresight point. The measurement settings for the first measurement to each point are used for all further sets.
Distance	To measure and display distances.
Store	To record data.

Description of fields

Field	Option	Description
Foresight ID	Editable field	The name of the foresight point.
Target height	Editable field	The target height of the foresight point.
Number of sets	Editable field	The number of sets to be measured.

Field	Option	Description
Hz	Display only	Displays the horizontal angle to the foresight point.
V	Display only	Displays the vertical angle to the foresight point.
Horizontal distance	Display only	Displays the calculated horizontal distance between the setup and foresight point.

Next step

Measure more foresight points or measure the set sequence.

Measure set sequence

1. **Foresight**
Foresight ID The name of the foresight point.
Target height The target height of the foresight point.
Number of sets The number of sets to be measured.

2. **Measure** to measure and record the foresight points. The measurement settings for the first measurement to each point are used for all further sets.

3. **Backsight, Set:**
Enter **Target height**.
Hz, V and Horizontal distance The measured values are displayed.

4. **Measure** to measure and record the backsight point.

Point Results

Key	Description
Store	To store the results and to quit.
Sets	To include or exclude measured sets in the calculation of a foresight point.
More	To display additional information.

Description of fields

Field	Option	Description
Point ID	Selectable list or display only	Selected point ID.
Target height	Selectable list or display only	The target height of the target point.
Backsight ID	Display only	The point ID of the backsight.
Number of sets	Display only	The number of sets out of all measured sets used for the calculation.
Hz arc average	Display only	Average horizontal angle.
V average	Display only	Average vertical angle.
Distance average	Display only	Average distance.

Field	Option	Description
H_z arc standard deviation	Display only	Standard deviation of horizontal angle.
V standard deviation	Display only	Standard deviation of vertical angle.
Distance standard deviation	Display only	Standard deviation of distance.
H_z spread	Display only	Spread of horizontal angle.
V spread	Display only	Spread of vertical angle.
Distance spread	Display only	Spread of distance.

Set Results

All the measured sets for the selected foresight are listed.

Check a box to include a set in the calculation.

Uncheck a box to exclude a set from the calculation.

The metadata and the foresight results are recalculated with the selection.

Key	Description
OK	To accept and store changes.
Add sets	To add more sets while still at the setup. It could be necessary that more than the designated number of sets is required. Possibly some of the sets from the first run exceeded the tolerance limit and must be disabled.
More	To display additional information.

Description of metadata

Field	Option	Description
H_z arc average	Display only	Average horizontal angle.
V average	Display only	Average vertical angle.
Distance average	Display only	Average distance.
H_z arc standard deviation	Display only	Standard deviation of horizontal angle.
V standard deviation	Display only	Standard deviation of vertical angle.
Distance standard deviation	Display only	Standard deviation of distance.
H_z spread	Display only	Spread of horizontal angle.
V spread	Display only	Spread of vertical angle.

Field	Option	Description
Distance spread	Display only	Spread of distance.

37.7

Export Cut Sheet

Description

To export a stake report showing the differences between the staked points and the design points.

Export Cut Sheet

Key	Description
OK	To return to the app.
Settings	To define the format of the data to be exported.

Description of fields

Field	Option	Description
Job	Display only	The job to export.
Cut sheet definition	Selectable list	The format is user defined and selectable.
To device	Selectable list	Defines where the exported data are saved to.  For To device: Internal memory the data is always exported to the \DATA directory.
To folder	Selectable list	The data can be exported to the \DATA or the root directory or to the folder where the selected job is located.
Output file	Editable field	The name of the file to which the data is exported.

Settings

Key	Description
OK	To store the settings.
Default	To recall the default export settings.

Description of fields

Field	Option	Description
Default file extension	Editable field	The extension of the file to which the data is exported. Default is "txt" but can be changed to anything else.
Filter to export	Entire job	To export all data from the working job.
	Current day	To export points staked on that day.
	Range of point IDs	To export points with point IDs between the entered start and end ID.

Field	Option	Description
Start ID and End ID	Editable field	Enter the range of points to be exported.

Select Cut Sheet Definition

Key	Description
OK	To return to the previous panel.
New	To create a new cut sheet definition. Refer to "Define Cut Sheet Content".
Edit	To edit the highlighted cut sheet definition. Refer to "Define Cut Sheet Content".
Delete	To delete the highlighted cut sheet definition.

Description of metadata

Metadata	Description
-	The name of the cut sheet definition.
Date	When the cut sheet definition was stored was stored.

Next step

New or **Edit** access a panel to define the cut sheet content.

Define Cut Sheet Content

Key	Description
OK	To return to the previous panel.
Clear	To set all fields to None .
Fn Default	To recall the default import settings.

Description of fields

Field	Option	Description
Cut sheet definition name	Editable field or display only	The name of the cut sheet definition.
Delimiter	Selectable list	The separator between the export variables.
Use table headers	Check box	When this box is checked, the text in each field below is used as header for the column. The header is displayed only once on the first row of the exported file.

Field	Option	Description
1st to 21th	Design point ID, Design code, Design code description, Design easting, Design northing, Design height, Staked point ID, Staking date, Staking time, Staked code description, Staked northing, Staked easting, Staked height, 1D quality, 2D quality, 3D quality, Cut, Fill, Difference in northing, and Difference in easting	Select the variable of the particular positions.

38.1

Overview

Description

COGO is an app to perform **coordinate geometry** calculations such as

- coordinates of points.
- bearings between points.
- distances between points.

The calculations can be made from

- existing point data in the job, known distances or known azimuths.
- manually measured points.
- entered coordinates.

In contrast to hidden point measurements within the Measure app, COGO is more of a calculation program than a measuring program.

Linked jobs and global data

If the working job has linked jobs, then the list of points available for the calculations contains points from the working job and the linked jobs.

If the working job has no linked jobs, then the points from the working job will be used.



Changing coordinates of a point which has been previously used in COGO does not result in the point being recomputed.

COGO calculation methods

The COGO calculation methods are:

- Inverse
- Bearing & distance
- Intersection
- Line and arc calculations
- Object division
- Shift, rotate & scale
- Angle calculations
- Horizontal curve
- Triangle

Distances and azimuths

Type	Description
Distances	The choices are <ul style="list-style-type: none"> • Ground • Grid • Ellipsoidal
Azimuths	The azimuths are grid azimuths relative to the local grid.

Coding of COGO points

- Point coding is available in the results panel after the COGO calculation. Point coding of COGO points is identical to coding manually measured points. Refer to "27 Coding" for information on coding.
- For the COGO calculation shift, rotate & scale, the codes from the original points are taken over for the calculated COGO points.

Access

1. Select **COGO** from the **Leica Captivate - Home** menu.
2. Select a COGO calculation method from the **COGO** menu.

COGO calculation methods

Description of the COGO calculation methods

COGO calculation methods	Description
Inverse	<p>To calculate the direction, the distance and the 3D coordinate differences between two known points (or one known point and the current GNSS position).</p> <p>To calculate the direction, the distance and the 3D coordinate differences between a known point (or the current GNSS position) and a user-defined line.</p> <p>To calculate the direction, the distance and the 3D coordinate differences between a known point (or the current GNSS position) and a user-defined arc.</p> <p>For these calculations, only points with full coordinate triplets or position only points can be used.</p>
Bearing & distance	<p>To calculate the position of new points using</p> <ul style="list-style-type: none"> • the azimuth/bearing and the distance from a known point. Offset optional. • the angle and the distance from a known point. Offset optional. <p>For these calculations, only points with full coordinate triplets or position only points can be used.</p>
Intersection	<p>To calculate the position of an intersection point using</p> <ul style="list-style-type: none"> • bearings from two known points. • a bearing and a distance from two known points. • distances from two known points. • four points. • two TS observation lines. <p>For these calculations, only points with full coordinate triplets or position only points can be used.</p>
Line & arc calculation	To calculate:

COGO calculation methods	Description
	<ul style="list-style-type: none"> • the centre point of an arc. • an offset point from a distance along, and offset from, an arc. • an offset point from a distance along, and offset from, a line. • a base point on an arc of a known offset point. • a base point on a line of a known offset point. • new points along an arc by segmentation. • new points along a line by segmentation.
Shift, rotate & scale	<p>To calculate the coordinates of new points using shifts, rotation and scale.</p> <p>The values for the shift, rotation and/or scale can either be entered manually or computed using selected matching points.</p> <p>For these calculations, points with full coordinate triplets, position only points or height only points can be used.</p>
Area division	<p>To divide an object by a</p> <ul style="list-style-type: none"> • defined line. • percentage. • defined size.
Angle	<p>To calculate the angles that are defined by three points.</p>
Horizontal curve	<p>To calculate the missing parameters of a curve by the input of the known parameters.</p>
Triangle	<p>To define a triangle by entering the three sides of the triangle or by selecting three points.</p>

38.3

Configuring COGO

Access

Press **Fn Settings** in the Input panel of a COGO calculation method.



Fn Settings is unavailable for **Angle**, **Horizontal curve**, and **Triangle**.

Settings, General page

This panel consists of several pages. The explanations given for the softkeys given are valid for all pages.

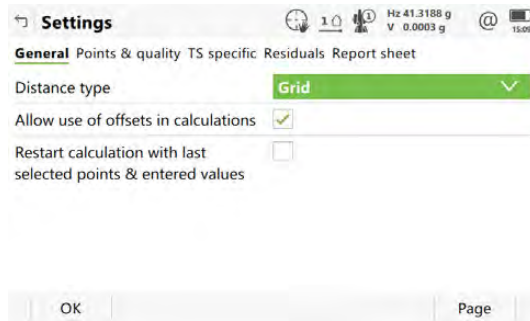

Key	Description
OK	To accept changes and return to the panel from where this panel was accessed.
Page	To change to another page on this panel.
Fn About	To display information about the program name, the version number, the date of the version, the copyright and the article number.

Description of fields

Field	Option	Description
Distance type	Grid	Distances are calculated as the trigonometric distance between the position of two points. The distance field is Horizontal distance .
	Ground	Distances are horizontal distances between two points at the mean elevation parallel to the ellipsoid of the active coordinate system. The distance field is Horizontal distance (ground) .
	Ellipsoid	Distances are reduced to the ellipsoid. They are calculated as the shortest distance between the two points on the ellipsoid. A scale factor is applied. The distance field is Horizontal distance (ellipsoid) .  In the attached coordinate system, a projection, an ellipsoid and a transformation have to be defined to calculate grid, ground and ellipsoid coordinates.
Allow use of offsets in calculations	Check box	Activates the use of offsets in the COGO calculations. Editable fields for the offsets are available in the Input panel of any COGO calculation method.

Field	Option	Description
Restart calculation with last selected points & entered values	Check box	When this box is checked, after storing a result, the Input page is displayed showing the previously used values.

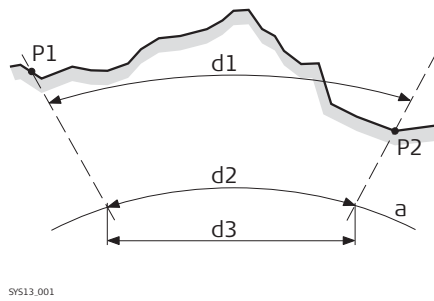

- a Ellipsoid
Known
P1 First known point
P2 Second known point
Unknown
d1 Ground distance
d2 Ellipsoid distance
d3 Grid distance

Next step

Page changes to the **Points & quality** page.

Settings, Points & quality page

Description of fields

Field	Option	Description
Store computed COGO points with class	Measured (Meas) or Control (Ctrl)	Defines the point class of COGO calculated and stored points as Measured (Meas) or Control (Ctrl) triplets.
Position quality for computed COGO point	Editable field	The estimated value for the position quality assigned to all calculated COGO points which is used for the averaging calculation.
Height quality for computed COGO point	Editable field	The estimated value for the height quality assigned to all calculated heights which is used for the averaging calculation.

Next step

Page changes to the **TS specific** page.

Settings, TS specific page

Description of fields

Field	Option	Description
Use two face measurements	Check box	Defines if the instrument measures the second face automatically after storing the first.

Field	Option	Description
		When this box is checked: After storing a measurement with Measure or Store motorised instruments change face automatically, non-motorised instruments access Telescope Positioning . The measurements of face I and face II are averaged on the base of face I. The averaged value is stored. When this box is not checked: No automatic measurement in two faces.
Compute ht when computing intersect pt using TS observations		Defines the height being used within TS observations.
	Using average	Using an average of the two observations.
	Use upper height	Using the upper height.
	Use lower height	Using the lower height.

Next step

Page changes to the **Residuals** page.

Settings, Residuals page

This page applies to **Shift, Rotate & Scale (Match Points)**.

Description of fields

Field	Option	Description
Easting	Editable field	The limit above which Easting residuals are flagged as possible outliers.
Northing	Editable field	The limit above which Northing residuals are flagged as possible outliers.
Height	Editable field	The limit above which Height residuals are flagged as possible outliers.
Residual Distbtn		The method by which the residuals of the control points are distributed throughout the transformation area.
	None	No distribution is made. Residuals remain with their associated points.
	1/distance, 1/distance² or 1/distance^{3/2}	Distributes the residuals according to the distance between each control point and the newly transformed point.

Field	Option	Description
	Multiquadratic	Distributes the residuals using a multiquadratic interpolation approach.

Next step

Page changes to the **Report sheet** page. Refer to "36 Apps - General".



Azimuth is used throughout this chapter. This term should also always be considered to mean **Bearing**.

38.4

COGO Calculation - Inverse Method

38.4.1

Selecting the Inverse Method

Access

Select **Inverse** from the **COGO** menu.

COGO Inverse

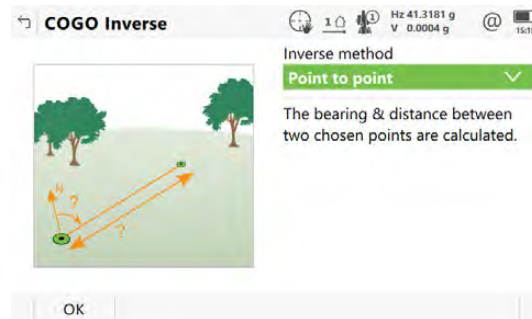

Key	Description
OK	To select a method and to continue with the subsequent panel.

Description of the Inverse methods

Inverse methods	Description
Point to point	<p>The direction, the distance and the coordinate differences between the two known points can be calculated depending on the data available. Points with full coordinate triplets, position only points and height only points can be used.</p> <p>Elements that must be known are</p> <ul style="list-style-type: none"> coordinates of two points. <p>The coordinates of the known points</p> <ul style="list-style-type: none"> can be taken from the job. can be manually measured during the COGO calculation. can be entered.

Inverse methods	Description
Point to current position	<p>The direction, distance and coordinate differences between the current rover position and a known point can be calculated depending on the data available. Points with full coordinate triplets, position only points and height only points can be used.</p> <p>Elements that must be known are</p> <ul style="list-style-type: none"> • coordinates of one point. <p>The coordinates of the known point</p> <ul style="list-style-type: none"> • can be taken from the job. • can be manually measured during the COGO calculation. • can be entered.
Current position to line	<p>The direction, distance and coordinate differences between the current position and a given line can be calculated depending on the data available. Points with full coordinate triplets, position only points and height only points can be used.</p> <p>Sufficient information must be known to define a line.</p> <p>The coordinates of the known points</p> <ul style="list-style-type: none"> • can be taken from the job. • can be measured during the COGO calculation. • can be entered.
Point to line	<p>The direction, distance and coordinate differences between a known point and a given line can be calculated depending on the data available. Points with full coordinate triplets, position only points and height only points can be used.</p> <p>Sufficient information to define a line and the coordinates of one point must be known.</p> <p>The coordinates of the known points</p> <ul style="list-style-type: none"> • can be taken from the job. • can be measured during the COGO calculation. • can be entered.
Point to arc	<p>The direction, distance and coordinate differences between the current position and a given arc can be calculated depending on the data available. Points with full coordinate triplets, position only points and height only points can be used.</p> <p>Sufficient information to define an arc and the coordinates of one point must be known.</p> <p>The coordinates of the known points</p> <ul style="list-style-type: none"> • can be taken from the job. • can be measured during the COGO calculation. • can be entered.

Inverse methods	Description
Current position to arc	<p>The direction, distance and coordinate differences between a known point and a given arc can be calculated depending on the data available. Points with full coordinate triplets, position only points and height only points can be used.</p> <p>Sufficient information must be known to define an arc.</p> <p>The coordinates of the known points</p> <ul style="list-style-type: none"> • can be taken from the job. • can be measured during the COGO calculation. • can be entered.

38.4.2

Point to Point and Current Position to Point

Diagram

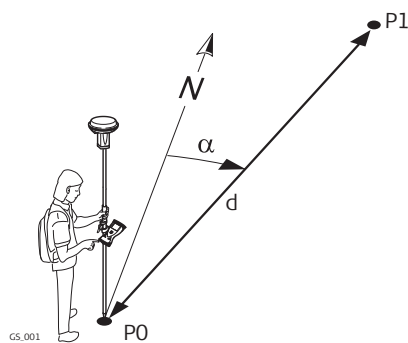

Known

- P0 First known point/current position
- P1 Second known point

Unknown

- α Direction from P0 to P1
- d Horizontal distance between P0 and P1

Inverse Point to Point/ Inverse Pt to Current Pos, Inverse page

For all point fields, 3D viewer can be used to select the desired point.

To type in coordinates for a known point, open a selectable list. Press **New** to create a point.

----- is displayed for unavailable information, for example **Height difference** cannot be calculated if a position only point is used.

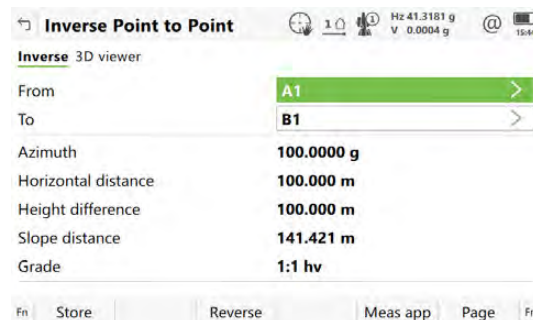

Key	Description
Store	To store the result.
Reverse	To swap the From and To points around.
Meas app	To measure a point manually for the COGO calculation. Available when From or To is highlighted.
Page	To change to another page on this panel.

Key	Description
Fn Settings	To configure the COGO app.

Description of fields

Field	Option	Description
From	Selectable list	The point ID of the first known point for the COGO calculation.
	Current position	Available for Inverse method: Point to current position.
To	Selectable list	The point ID of the second known point for the COGO calculation.
	Current position	Available for Inverse method: Point to current position.
Azimuth	Display only	The direction from the first to the second known point.
Horizontal distance, Horizontal distance (ground) or Horizontal distance (ellipsoid)	Display only	The horizontal distance between the two known points.
Height difference	Display only	The height difference between the two known points.
Slope distance	Display only	The slope distance between the two known points.
Grade	Display only	The grade between the two known points.
Difference in easting	Display only	The difference in Easting between the two known points.
Difference in northing	Display only	The difference in Northing between the two known points.

Next step

The calculated distance between the two known points is indicated in 3D viewer.

Diagram

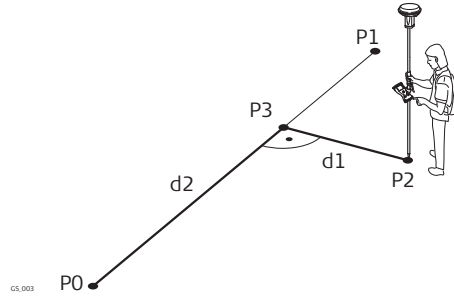
**Known**

- P0 Start point
- P1 End point
- P2 Offset point

Unknown

- P3 Base point
- d1 Offset distance
- d2 Δ Line distance

Inverse Point to Line/ Inverse Current Pos to Line, Input page

For all point fields, 3D viewer can be used to select the desired point.

To type in coordinates for a known point open a selectable list. Press **New** to create a point.

----- is displayed for unavailable information, for example **Height difference** cannot be calculated if a position only point is used.

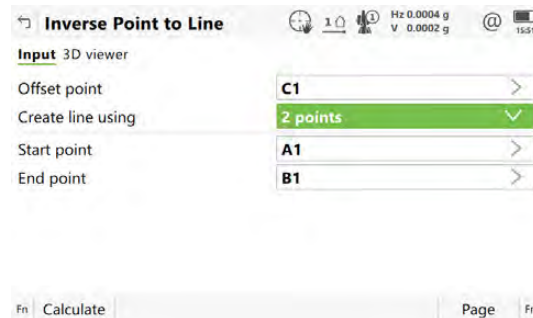

Key	Description
Calculate	To calculate COGO point.
Inverse	To calculate the values for the distance and the offset from two existing points. Available if Azimuth or Horizontal distance is highlighted.
Last Inv	To recall previous results from COGO inverse calculations. Available if Azimuth or Horizontal distance is highlighted.
Meas app	To measure a point manually for the COGO calculation. Available if Start point , End point or Offset point is highlighted.
Page	To change to another page on this panel.
Fn Settings	To configure the COGO app.
Fn Modify	To modify the values manually. Available if Azimuth or Horizontal distance is highlighted.

Description of fields

Field	Option	Description
Offset point	Selectable list	Available for Inverse method: Point to line . The offset point.

Field	Option	Description
	Current position	Available for Inverse method: Current position to line.
Create line using		The method by which the line is defined.
	2 points	Uses two known points to define the line.
	Point, bearing & distance	Defines the line using a known point, a distance and an azimuth of the line.
Start point	Selectable list	The start point of the line.
End point	Selectable list	Available for Method: 2 points. The end point of the line.
Azimuth	Editable field	Available for Method: Point, bearing & distance. The azimuth of the line.
Horizontal distance, Horizontal distance (ground) or Horizontal distance (ellipsoid)	Editable field	Available for Method: Point, bearing & distance. The horizontal distance from the start point to the end point of the line.

Next step

Calculate calculates and accesses **Inverse Result.**

Inverse Result, Result page

Field	Value
Offset point	C1
Distance along line	50.000 m
Offset	-50.000 m
Bearing to offset point	0.0000 g
Line length	100.000 m
Line bearing	100.0000 g
Easting	50.000 m

Key	Description
Store	To store the result.
Page	To change to another page on this panel.

Description of fields

Field	Option	Description
Offset point	Display only	Point ID of offset point or Current position.
Distance along line	Display only	Horizontal distance from start point to base point.

Field	Option	Description
Offset	Display only	Offset from base point to offset point. Positive to the right and negative to the left of the line.
Bearing to offset point	Display only	Bearing from base point to offset point.
Line length	Display only	Length of line from start point to end point.
Line bearing	Display only	Bearing of line from start point to end point.
Easting and Northing	Display only	The calculated coordinates.
Height	Display only	The height of the calculated point.

Next step

Page changes to the **3D viewer** page.

38.4.4

Point to Arc and Current Position to Arc

Diagram

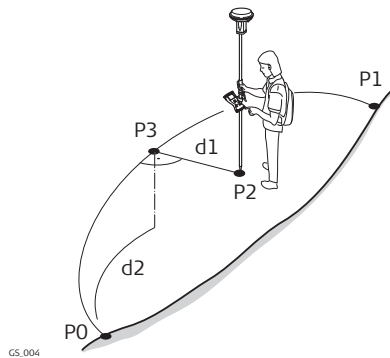

Known

- P0 Start point
- P1 End point
- P2 Offset point

Unknown

- P3 Base point
- d1 Offset-XX
- d2 Δ ArcDist-XX

Point to arc/ Current position to arc, Input page

For all point fields, 3D viewer can be used to select the desired point.

To type in coordinates for a known point open a selectable list. Press **New** to create a point.

----- is displayed for unavailable information, for example **Height difference** cannot be calculated if a position only point is used.

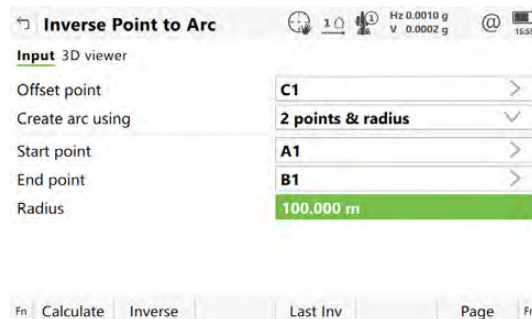

Key	Description
Calculate	To calculate COGO point.

Key	Description
Inverse	To calculate the values for the distance and the offset from two existing points. Available if Radius , Arc length or Chord length is highlighted.
Last Inv	To recall previous results from COGO inverse calculations. Available if Radius , Arc length or Chord length is highlighted.
Meas app	To measure a point manually for the COGO calculation. Available if Start point , Second point , End point , Offset point or PI point is highlighted.
Page	To change to another page on this panel.
Fn Settings	To configure the COGO app.
Fn Modify	To modify the values manually. Available if Radius , Arc length or Chord length is highlighted.

Description of fields

Field	Option	Description
Offset point	Selectable list	Available for Point to arc: Point to line . The offset point.
	Current position	Available for Inverse method: Current position to arc .
Create arc using		The method by which the arc is defined.
	3 points	Uses three known points to define the arc.
	2 points & radius	Defines the arc using two known points and a radius of the arc.
	2 tangents & radius	Defines the arc using two tangents and a radius of the arc.
	2 tangents & arc length	Defines the arc using two tangents and the length of the arc.
	2 tangents & chord length	Defines the arc using two tangents and the chord of the arc.
Start point	Selectable list	The start point of the arc. Available for Method: 3 points and Method: 2 points & radius .
Second point	Selectable list	The second point of the arc. Available for Method: 3 points .
End point	Selectable list	The end point of the arc. Available for Method: 3 points and Method: 2 points & radius .
Point 1	Selectable list	A point on the first tangent. Available for Method: 2 tangents & radius , Method: 2 tangents & arc length and Method: 2 tangents & chord length .

Field	Option	Description
PI point	Selectable list	The point of intersection of the two tangents. Available for Method: 2 tangents & radius , Method: 2 tangents & arc length and Method: 2 tangents & chord length .
Point 2	Selectable list	A point on the second tangent. Available for Method: 2 tangents & radius , Method: 2 tangents & arc length and Method: 2 tangents & chord length .
Radius	Editable field	The radius of the arc. Available for Method: 2 points & radius and Method: 2 tangents & radius .
Arc length	Editable field	The length of the arc. Available for Method: 2 tangents & arc length .
Chord length	Editable field	The length of the chord. Available for Method: 2 tangents & chord length .

Next step

Calculate calculates the result and accesses **Inverse Result**.

Inverse Result, Result page

Inverse Result	
Result 3D viewer	
Offset point	C1
Distance along arc	-70.137 m
Offset	52.523 m
Bearing to offset point	276.8230 g
Arc radius	100.000 m
Arc length	182.348 m
Easting	49.081 m

Key	Description
Store	To store the result.
Page	To change to another page on this panel.

Description of fields

Field	Option	Description
Offset point	Display only	Point ID of offset point for Inverse method: Point to arc or current position.
Distance along arc	Display only	Horizontal distance along the arc from start point to base point.
Offset	Display only	Offset from base point to offset point. Positive to the right and negative to the left of the line.
Bearing to offset point	Display only	Bearing of offset point from base point to offset point.
Arc radius	Display only	Computed radius of arc.

Field	Option	Description
Arc length	Display only	Computed length of arc.
Easting and Northing	Display only	The calculated coordinates.
Height	Display only	The height of the calculated point.

Next step

Page changes to the **3D viewer** page.

38.5

COGO Calculation - Traverse Method

Description

Elements that must be known are

- the coordinates of one point.
- the direction from the known point to the COGO point.
- the distance from the known point to the COGO point.
- offsets, if necessary and configured.

The coordinates of the known point

- can be taken from the job.
- can be manually measured during the COGO calculation.
- can be entered.

The direction from the known point to the COGO point can be an azimuth or an angle.

Points with full coordinate triplets and position only points can be used. Position only is calculated, height can be typed in.

A COGO traverse calculation can be calculated for

- a single point.
- multiple points. Several single points are calculated in one sequence.
- sideshots.

Diagram

COGO traverse calculation with offset for a single point

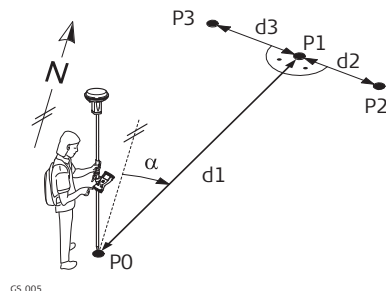

Known

- P0 Known point
- α Direction from P0 to P1
- d1 Distance between P0 and P1
- d2 Positive offset to the right
- d3 Negative offset to the left

Unknown

- P1 COGO point without offset
- P2 COGO point with positive offset
- P3 COGO point with negative offset

COGO traverse calculation without offset for multiple points

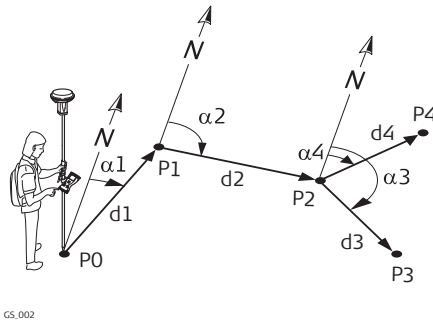

CS_002

Known

- P0 Known point
- α_1 Direction from P0 to P1
- α_2 Direction from P1 to P2
- α_3 Direction from P2 to P3
- α_4 Direction from P2 to P4
- d1 Distance between P0 and P1
- d2 Distance between P1 and P2
- d3 Distance between P2 and P3
- d4 Distance between P2 and P4

Unknown

- P1 First COGO point
- P2 Second COGO point
- P3 Third COGO point - sideshot
- P4 Fourth COGO point

Bearing & Distance Input, Input page

For all point fields, 3D viewer can be used to select the desired point.

To type in coordinates for a known point open a selectable list. Press **New** to create a point.

Key	Description
Calculate	To calculate the result.
Inverse	To calculate the values for the distance and the offset from two existing points. Available when Azimuth , Horizontal distance , Offset or Angle right is highlighted.
Side shot	To calculate the point as a sideshot.
Last Inv	To recall previous results from COGO inverse calculations. Available when Azimuth , Horizontal distance , Offset or Angle right is highlighted.
Meas app	To measure a point manually for the COGO calculation. Available when From or Backsight is highlighted.
Page	To change to another page on this panel.
Fn Settings	To configure the COGO app.
Fn Modify	To add, subtract, multiply and divide values. Available when Azimuth , Horizontal distance , Offset or Angle right is highlighted.

Description of fields

Field	Option	Description
Method	Azimuth	The direction from the known point to the COGO point is an azimuth.
	Angle right	The direction from the known point to the COGO point is an angle.
From	Selectable list	The point ID of the known point for the COGO calculation.
Backsight	Selectable list	The point ID of a point used as backsight. Available for Method: Angle right .
Angle right	Editable field	The angle between Backsight and the new COGO point to be calculated from the point selected as From . A positive value is for clockwise angles. A negative value is for anti-clockwise angles. Available for Method: Angle right .
Azimuth	Editable field	The direction from the known point to the COGO point.
Horizontal distance, Horizontal distance (ground) or Horizontal distance (ellipsoid)	Editable field	The horizontal distance between the known point and the COGO point.
Offset	Editable field	The offset of the COGO point from the line of direction. A positive offset is to the right, a negative offset is to the left. Available when Allow use of offsets in calculations is ticked in Settings, General page.

Next step

Calculate calculates the result and accesses **Bearing & Distance Results**.

Bearing & Distance Results, Result page

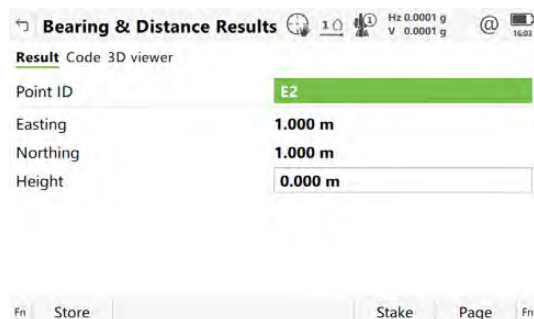

Key	Description
Store	To store the result.

Key	Description
Stake	To access the Stakeout app and stake out the calculated COGO point.
Page	To change to another page on this panel.
Fn Coord	To view other coordinate types.
Fn Ell Ht and Fn Height	To change between the ellipsoidal and the orthometric height. Available for local coordinates.
Fn Tools	Refer to "37 Apps - The Toolbox".

Description of fields

Field	Option	Description
Point ID	Editable field	The identifier for the COGO point depending on the point ID template configured for the currently active instrument type in ID Templates . The point ID can be changed.
Easting and Northing	Display only	The calculated coordinates.
Height	Editable field	The height of the known point used in the COGO calculation is suggested. A height value to be stored with the calculated point can be typed in.

Next step

On the **Code** page, type in a code if desired.

On the **3D viewer** page, an arrow points from the known point to the calculated COGO point.

Store stores the result.

38.6

COGO Calculation - Intersection Method

38.6.1

Selecting the Intersection Method

Access

Select **Intersection** from the **COGO** menu.

COGO Intersection

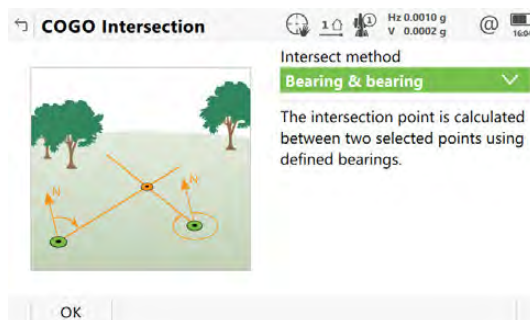

Key	Description
OK	To select a method and to continue with the subsequent panel.

Description of the Intersection methods

Intersection methods	Description
Bearing & bearing	<p>Calculates the intersection point of two lines. A line is defined by a point and a direction.</p> <p>Elements that must be known are</p> <ul style="list-style-type: none">• the coordinates of two points.• the direction from these known points to the COGO point.• offsets if necessary and configured. <p>The coordinates of the known points</p> <ul style="list-style-type: none">• can be taken from the job.• can be manually measured during the COGO calculation.• can be entered. <p>Points with full coordinate triplets and position only points can be used. Position only is calculated, height can be typed in.</p>
Distance & distance	<p>Calculates the intersection point of two circles. The circles are defined by the known point as the centre point and the distance from the known point to the COGO point as the radius.</p> <p>Elements that must be known are</p> <ul style="list-style-type: none">• the coordinates of two points.• the distance from the known points to the COGO point. <p>The coordinates of the known points</p> <ul style="list-style-type: none">• can be taken from the job.• can be manually measured during the COGO calculation.• can be entered. <p>Points with full coordinate triplets and position only points can be used.</p>

Intersection methods	Description
Bearing & distance	<p>Calculates the intersection point of a line and a circle. The line is defined by a point and a direction. The circle is defined by the centre point and the radius.</p> <p>Elements that must be known are</p> <ul style="list-style-type: none"> • the coordinates of points. • the direction from one known point to the COGO point. • the distance from the second known point to the COGO point. • offsets if necessary and configured. <p>The coordinates of the known points</p> <ul style="list-style-type: none"> • can be taken from the job. • can be manually measured during the COGO calculation. • can be entered. <p>Points with full coordinate triplets and position only points can be used.</p>
Four points	<p>Calculates the intersection point of two lines. A line is defined by two points.</p> <p>Elements that must be known are</p> <ul style="list-style-type: none"> • the coordinates of four points. • offsets of the lines if necessary and configured. <p>The coordinates of the known points</p> <ul style="list-style-type: none"> • can be taken from the job. • can be manually measured during the COGO calculation. • can be entered. <p>Points with full coordinate triplets and position only points can be used.</p>
Two TS observations	<p>Calculates the intersection point of two lines. A line is defined by a TPS setup and a TPS measurement from this setup.</p> <p>Elements that must be known are</p> <ul style="list-style-type: none"> • the coordinates of two points. • azimuths of the lines. <p>The coordinates of the known points</p> <ul style="list-style-type: none"> • must be taken from the job. • must be TPS setup points. <p>The azimuths of the lines</p> <ul style="list-style-type: none"> • must be TPS measurements from the known points. <p>Points with full coordinate triplets and position only points can be used.</p>

Diagram

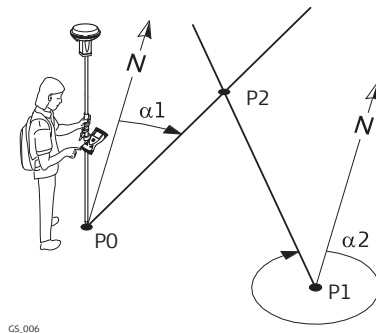

Known

- P0 First known point
- P1 Second known point
- α_1 Direction from P0 to P2
- α_2 Direction from P1 to P2

Unknown

- P2 COGO point

Intersection Brng & Brng, Input page

For all point fields, the 3D viewer can be used to select the desired point. To type in coordinates for a known point open a selectable list. Press **New** to create a point.



Key	Description
Calculate	To calculate the result.
Inverse	To calculate the values for the distance and the offset from two existing points. Available when Azimuth or Offset is highlighted.
Last Inv	To recall previous results from COGO inverse calculations. Available when Azimuth or Offset is highlighted.
Meas app	To measure a point manually for the COGO calculation. Available when 1st point or 2nd point is highlighted.
Page	To change to another page on this panel.
Fn Settings	To configure the COGO app.
Fn Modify	To add, subtract, multiply and divide values. Available when Azimuth or Offset is highlighted.

Description of fields

Field	Option	Description
1st point	Selectable list	The point ID of the first known point for the COGO calculation.
2nd point	Selectable list	The point ID of the second known point for the COGO calculation.

Field	Option	Description
Azimuth	Editable field	The direction from the first known point to the COGO point.
Offset	Editable field	The offset of the COGO point from the line of direction. A positive offset is to the right, a negative offset is to the left. Available when Allow use of offsets in calculations is ticked in Settings, General page.

Next step

Calculate calculates the result and accesses **Intersection Brng & Brng**.

Intersection Result, Result page

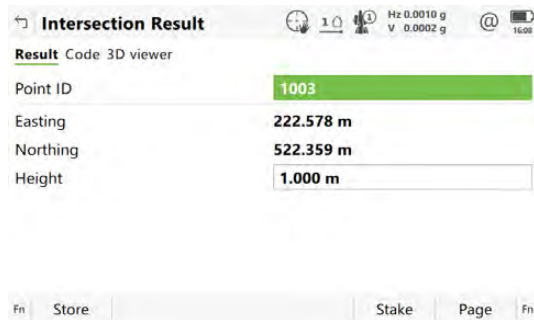

Key	Description
Store	To store the result.
Stake	To access the Stakeout app and stake out the calculated COGO point.
Page	To change to another page on this panel.
Fn Coord	To view other coordinate types.
Fn Ell Ht and Fn Height	To change between the ellipsoidal and the orthometric height. Available for local coordinates.
Fn Tools	Refer to "37 Apps - The Toolbox".

Description of fields

Field	Option	Description
Point ID	Editable field	The identifier for the COGO point depending on the point ID template configured for Auxiliary points in ID Templates . The point ID can be changed.
Easting and Northing	Display only	The calculated coordinates.
Height	Editable field	The height of the first point used in the COGO calculation is suggested. A height value to be stored with the calculated point can be typed in.

Next step

On the **Code** page, type in a code if desired.

On the **3D viewer** page, arrows point from the known points to the calculated COGO point.

Store stores the result.

38.6.3

Intersection with Distance & Distance

Diagram

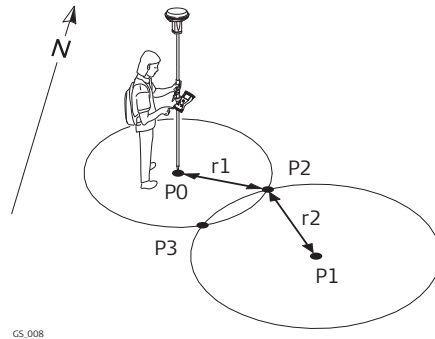

Known

- P0 First known point
- P1 Second known point
- r1 Radius, as defined by the distance from P0 to P2
- r2 Radius, as defined by the distance from P1 to P2

Unknown

- P2 First COGO point
- P3 Second COGO point

Intersection Dist & Dist, Input page

For all point fields, the 3D viewer can be used to select the desired point.

To type in coordinates for a known point open a selectable list. Press **New** to create a point.

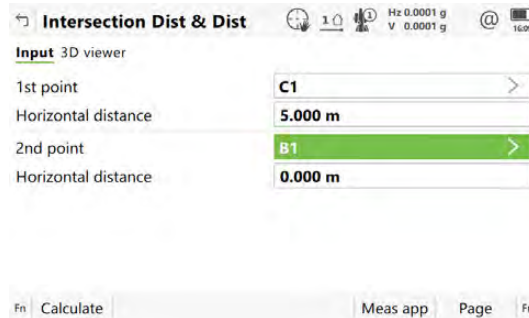

Key	Description
Calculate	To calculate the result.
Inverse	To calculate the values for the distance and the offset from two existing points. Available when Horizontal distance is highlighted.
Last Inv	To recall previous results from COGO inverse calculations. Available when Horizontal distance is highlighted.
Meas app	To measure a point manually for the COGO calculation. Available when 1st point or 2nd point is highlighted.
Page	To change to another page on this panel.
Fn Settings	To configure the COGO app.
Fn Modify	To add, subtract, multiply and divide values. Available when Horizontal distance is highlighted.

Description of fields

Field	Option	Description
1st point	Selectable list	The point ID of the first known point for the COGO calculation.
2nd point	Selectable list	The point ID of the second known point for the COGO calculation.
Horizontal distance, Horizontal distance (ground) or Horizontal distance (ellipsoid)	Editable field	The horizontal distance between the known points and the COGO point.

Next step

Calculate calculates the result and accesses **Intersection Result**.

Intersection Result,
Result 1/
Result 2 page

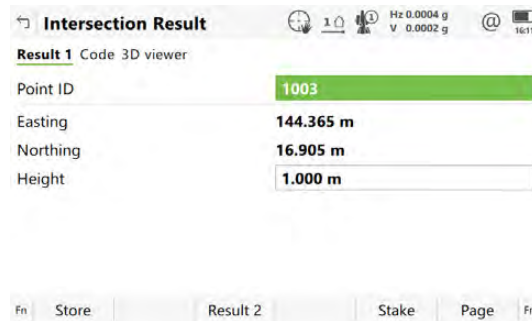

Key	Description
Store	To store the result.
Result 1 or Result 2	To view the first and second result.
Stake	To access the Stakeout app and stake out the calculated COGO point.
Page	To change to another page on this panel.
Fn Coord	To view other coordinate types.
Fn Ell Ht and Fn Height	To change between the ellipsoidal and the orthometric height. Available for local coordinates.
Fn Tools	Refer to "37 Apps - The Toolbox".

Description of fields

Field	Option	Description
Point ID	Editable field	The identifier for the COGO point depending on the point ID template configured for GS points / TS points in ID Templates . The point ID can be changed.

Field	Option	Description
Easting and Northing	Display only	The calculated coordinates.
Height	Editable field	The height of the first point used in the COGO calculation is suggested. A height value to be stored with the calculated point can be typed in.

Next step

On the **Code** page, type in a code if desired.

On the **3D viewer** page, arrows point from the known points to the calculated COGO point.

Store stores the result.

38.6.4

Intersection with Bearing & Distance

Diagram

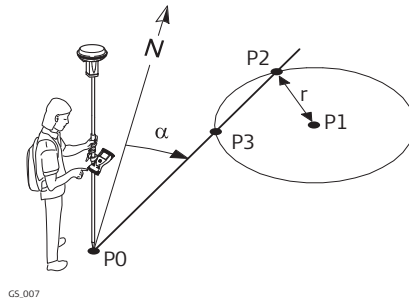

Known

- P0 First known point
- P1 Second known point
- α Direction from P0 to P2
- r Radius, as defined by the distance from P1 to P2

Unknown

- P2 First COGO point
- P3 Second COGO point

Intersection Brng & Dist, Input page

For all point fields, the 3D viewer can be used to select the desired point.

To type in coordinates for a known point open a selectable list. Press **New** to create a point.

Key	Description
Calculate	To calculate the result.
Inverse	To calculate the values for the distance and the offset from two existing points. Available when Azimuth , Horizontal distance or Offset is highlighted.

Key	Description
Last Inv	To recall previous results from COGO inverse calculations. Available when Azimuth , Horizontal distance or Offset is highlighted.
Meas app	To measure a point manually for the COGO calculation. Available when 1st point or 2nd point is highlighted.
Page	To change to another page on this panel.
Fn Settings	To configure the COGO app.
Fn Modify	To add, subtract, multiply and divide values. Available when Azimuth , Horizontal distance or Offset is highlighted.

Description of fields

Field	Option	Description
1st point	Selectable list	The point ID of the first known point for the COGO calculation.
2nd point	Selectable list	The point ID of the second known point for the COGO calculation.
Azimuth	Editable field	The direction from the first known point to the COGO point.
Offset	Editable field	The offset of the COGO point from the line of direction. A positive offset is to the right, a negative offset is to the left. Available for Allow use of offsets in calculations: Yes in Measure Settings, General page.
Horizontal distance, Horizontal distance (ground) or Horizontal distance (ellipsoid)	Editable field	The horizontal distance between the known point and the COGO point.

Next step

Calculate calculates the result and accesses **Intersection Result**.

Intersection Result, Result page

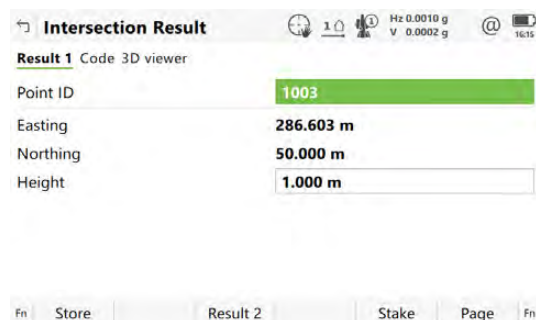

Key	Description
Store	To store the result.
Result 1 or Result 2	To view the first and second result.
Stake	To access the Stakeout app and stake out the calculated COGO point.
Page	To change to another page on this panel.
Fn Coord	To view other coordinate types.
Fn Ell Ht and Fn Height	To change between the ellipsoidal and the orthometric height. Available for local coordinates.
Fn Tools	Refer to "37 Apps - The Toolbox".

Description of fields

Field	Option	Description
Point ID	Editable field	The identifier for the COGO point depending on the point ID template configured for GS points / TS points in ID Templates . The point ID can be changed.
Easting and Northing	Display only	The calculated coordinates.
Height	Editable field	The height of the first point used in the COGO calculation is suggested. A height value to be stored with the calculated point can be typed in.

Next step

On the **Code** page, type in a code if desired.

On the **3D viewer** page, an arrow points from the first known points to the calculated COGO point.

Store stores the result.

38.6.5

Intersection with Four Points

Diagram

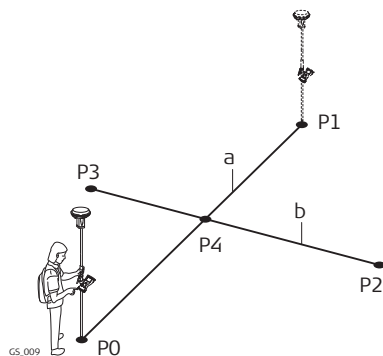

Known

- P0 First known point
- P1 Second known point
- P2 Third known point
- P3 Fourth known point
- a Line from P0 to P1
- b Line from P2 to P3

Unknown

- P4 COGO point

Four Point Intersection, Input page

For all point fields, the 3D viewer can be used to select the desired point. To type in coordinates for a known point open a selectable list. Press **New** to create a point.

Key	Description
Calculate	To calculate the result.
Inverse	To calculate the values for the distance and the offset from two existing points. Available when Offset is highlighted.
Last Inv	To recall previous results from COGO inverse calculations. Available when Offset is highlighted.
Meas app	To measure a point manually for the COGO calculation. Available when 1st point , 2nd point , 3rd point or 4th point is highlighted.
Page	To change to another page on this panel.
Fn Settings	To configure the COGO app.
Fn Modify	To add, subtract, multiply and divide values. Available when Offset is highlighted.

Description of fields

Field	Option	Description
1st point	Selectable list	The point ID of the known start point of the first line for the COGO calculation.
2nd point	Selectable list	The point ID of the known end point of the first line for the COGO calculation.
3rd point	Selectable list	The point ID of the known start point of the second line for the COGO calculation.
4th point	Selectable list	The point ID of the known end point of the second line for the COGO calculation.
Offset	Editable field	The offset of the line in the direction 1st point to 2nd point or 3rd point to 4th point . A positive offset is to the right, a negative offset is to the left. Available for Allow use of offsets in calculations: Yes in Measure Settings, General page.

Next step

Calculate calculates the result and accesses **Intersection Result**.

Intersection Result, Result page

Intersection Result Hz 0.0001 g V 0.0001 g 16:19

Result Code 3D viewer

Point ID **1005**

Easting **12.500 m**

Northing **37.500 m**

Height **1.000 m**

Fn Store Stake Page Fn

Key	Description
Store	To store the result.
Stake	To access the Stakeout app and stake out the calculated COGO point.
Page	To change to another page on this panel.
Fn Coord	To view other coordinate types.
Fn Ell Ht and Fn Height	To change between the ellipsoidal and the orthometric height. Available for local coordinates.
Fn Tools	Refer to "37 Apps - The Toolbox".

Description of fields

Field	Option	Description
Point ID	Editable field	The identifier for the COGO point depending on the point ID template configured for GS points / TS points in ID Templates . The point ID can be changed.
Easting and Northing	Display only	The calculated coordinates.
Height	Editable field	The height of the first point used in the COGO calculation is suggested. A height value to be stored with the calculated point can be typed in.

Next step

On the **Code** page, type in a code if desired.

On the **3D viewer** page, two solid lines are displayed.

Store stores the result.

Diagram

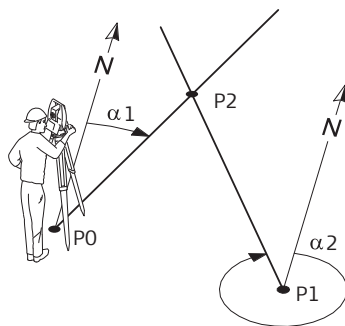

TS_001

Known

- P0 First known point (TS setup)
- P1 Second known point (TS setup)
- $\alpha 1$ Direction from P0 to P2
- $\alpha 2$ Direction from P1 to P2

Unknown

- P2 COGO point

Two TS Observations, Input page

For all point fields, the 3D viewer can be used to select the desired point. To type in coordinates for a known point open a selectable list. Press **New** to create a point.

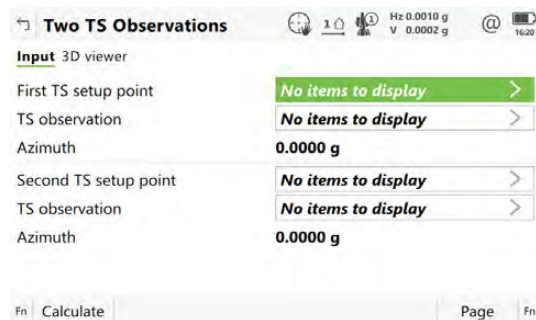

Key	Description
Calculate	To calculate the result.
Meas app	To measure a point manually for the COGO calculation. Available when First TS setup point or Second TS setup point is highlighted and the selected setup is the active TS setup.
Page	To change to another page on this panel.
Fn Settings	To configure the COGO app.

Description of fields

Field	Option	Description
First TS setup point	Selectable list	The point ID of the first TS setup which is the known start point of the first line for the COGO calculation.
TS observation	Selectable list	The point ID of the TS measurement which is the known end point of the first line for the COGO calculation.
Azimuth	Display only	The azimuth related to the known end point of the first/second line for the COGO calculation.

Field	Option	Description
Second TS setup point	Selectable list	The point ID of the second TS setup which is the known start point of the second line for the COGO calculation.
TS observation	Selectable list	The point ID of the TS measurement which is the known end point of the second line for the COGO calculation.

Next step

Calculate calculates the result and accesses **Intersection Result**.

Intersection Result, Result page

Key	Description
Store	To store the result.
Stake	To access the Stakeout app and stake out the calculated COGO point.
Page	To change to another page on this panel.
FnCoord	To view other coordinate types.
Fn Ell Ht and Fn Height	To change between the ellipsoidal and the orthometric height. Available for local coordinates.
Fn Tools	Refer to "37 Apps - The Toolbox".

Description of fields

Field	Option	Description
Point ID	Editable field	The identifier for the COGO point depending on the point ID template configured for GS points / TS points in ID Templates . The point ID can be changed.
Computed height	Display only	The height being used as defined on Settings, TS specific page.
Easting and Northing	Display only	The calculated coordinates.
Height	Editable field	The height of the first point used in the COGO calculation is suggested. A height value to be stored with the calculated point can be typed in.

Next step

On the **Code** page, type in a code if desired.

On the **3D viewer** page, arrows point from the known points to the calculated COGO point.

On the **Checks** page, values for check are displayed:

- the difference between the height calculations from **First TS setup point** and **Second TS setup point**
- the horizontal distances from both setup points to the calculated point.

Store stores the result.

Access

Select **Line & arc calculation** from the **COGO** menu.

COGO Line/Arc Calculation

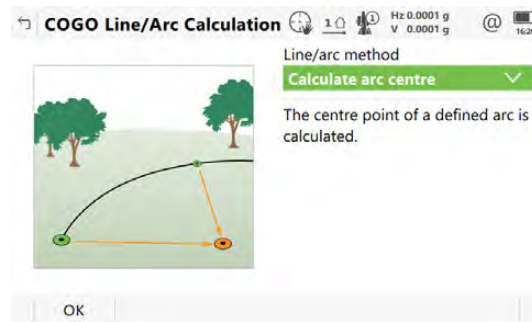

Key	Description
OK	To select a method and to continue with the subsequent panel.

Description of the Line/Arc methods

Line/Arc Methods	Description
Calculate arc centre	<p>Calculates the coordinates of the centre of the arc.</p> <p>Elements that must be known are</p> <ul style="list-style-type: none"> • coordinates of three points <p>OR</p> <ul style="list-style-type: none"> • coordinates of two points • radius to the two points <p>The coordinates of the known points</p> <ul style="list-style-type: none"> • can be taken from the job. • can be measured during the COGO calculation. • can be entered.
Calculate arc offset point	<p>Calculates the coordinates of a new point after input of arc and offset values in relation to an arc.</p> <p>Elements that must be known are</p> <ul style="list-style-type: none"> • coordinates of three points. • offsets. <p>OR</p> <ul style="list-style-type: none"> • coordinates of two points. • radius to the two points. • offsets. <p>The coordinates of the known points</p> <ul style="list-style-type: none"> • can be taken from the job. • can be measured during the COGO calculation. • can be entered.

Line/Arc Methods	Description
Calculate line offset point	<p>Calculates the coordinates of a new point after input of station and offset values in relation to a line.</p> <p>Elements that must be known are</p> <ul style="list-style-type: none"> • coordinates of two points. • offsets. <p>OR</p> <ul style="list-style-type: none"> • coordinates of one point. • bearing and distance from one point. • offsets. <p>The coordinates of the known points</p> <ul style="list-style-type: none"> • can be taken from the job. • can be measured during the COGO calculation. • can be entered.
Calculate arc base point	<p>Calculates the coordinates of the base point, station and offset of a point in relation to an arc.</p> <p>Elements that must be known are</p> <ul style="list-style-type: none"> • coordinates of three points • coordinates of an offset point <p>OR</p> <ul style="list-style-type: none"> • coordinates of two points • radius to the two points • coordinates of an offset point <p>The coordinates of the known points</p> <ul style="list-style-type: none"> • can be taken from the job. • can be measured during the COGO calculation. • can be entered.
Calculate line base point	<p>Calculates the base point, station and offset of a point in relation to a line.</p> <p>Elements that must be known are</p> <ul style="list-style-type: none"> • coordinates of two points and an offset point. <p>OR</p> <ul style="list-style-type: none"> • coordinates of one point and an offset point • bearing and distance from one point <p>The coordinates of the known points</p> <ul style="list-style-type: none"> • can be taken from the job. • can be measured during the COGO calculation. • can be entered.
Segment an arc	<p>This method is similar to Segment a line. See the following row.</p>

Line/Arc Methods	Description
Segment a line	<p>Calculates the coordinates of new points on a line.</p> <p>Elements that must be known are</p> <ul style="list-style-type: none"> coordinates of the start and the end point of the line <p>OR</p> <ul style="list-style-type: none"> a bearing and distance from a known point that define the line <p>AND EITHER</p> <ul style="list-style-type: none"> the number of segments dividing the line <p>OR</p> <ul style="list-style-type: none"> a segment length for the line. <p>The coordinates of the known points</p> <ul style="list-style-type: none"> can be taken from the job. can be measured during the COGO calculation. can be entered.

38.7.2

Arc Calculation

Diagram for arc centre

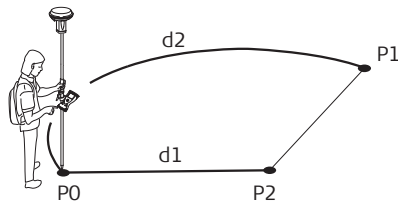

GS.010

- P0 **Start point**
- P1 **End point**
- P2 **Arc centre**
- d1 **Arc radius**
- d2 **Arc length**

Diagram for arc base point and offset point

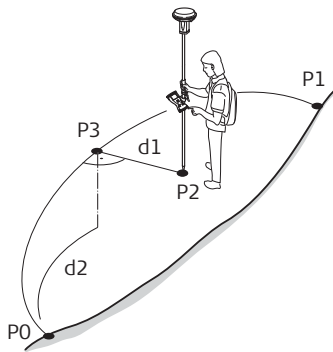

GS.004

- P0 **Start point**
- P1 **End point**
- P2 **Offset point**
- P3 **Base point**
- d1 **Offset**
- d2 **Distance along arc**

Create Arc, Input page

The softkeys are similar to line calculation. Refer to "38.7.3 Calculate Line Offset Point and Calculate Line Base Point" for information on softkeys.

Description of fields

Field	Option	Description
Create arc using		The method by which the arc is defined.
	3 points	Uses three known points to define the arc.
	2 points & radius	Defines the arc using two known points and a radius of the arc.
	2 tangents & radius	Defines the arc using two tangents and a radius of the arc.
	2 tangents & arc length	Defines the arc using two tangents and the length of the arc.
2 tangents & chord length	Defines the arc using two tangents and the chord of the arc.	
Start point	Selectable list	The start point of the arc. Available for Create arc using: 3 points and Create arc using: 2 points & radius .
Second point	Selectable list	The second point of the arc. Available for Create arc using: 3 points .
End point	Selectable list	The end point of the arc. Available for Create arc using: 3 points and Create arc using: 2 points & radius .
Point 1	Selectable list	A point on the first tangent. Available for Create arc using: 2 tangents & radius , Create arc using: 2 tangents & arc length and Create arc using: 2 tangents & chord length .
PI point	Selectable list	The point of intersection of the two tangents. Available for Create arc using: 2 tangents & radius , Create arc using: 2 tangents & arc length and Create arc using: 2 tangents & chord length .
Point 2	Selectable list	A point on the second tangent. Available for Create arc using: 2 tangents & radius , Create arc using: 2 tangents & arc length and Create arc using: 2 tangents & chord length .
Radius	Editable field	The radius of the arc. Available for Create arc using: 2 points & radius and Create arc using: 2 tangents & radius .
Arc length	Editable field	The length of the arc. Available for Create arc using: 2 tangents & arc length .
Chord length	Editable field	The length of the chord. Available for Create arc using: 2 tangents & chord length .

Next step

IF	THEN
Line/arc method: Calculate arc centre	Calculate accesses Centre of Arc Result .
Line/arc method: Calculate arc offset point	OK accesses Calculation Input .
Line/arc method: Calculate arc base point	OK accesses Calculation Input .

Calculation Input,
Input page

Description of fields

Field	Option	Description
Distance along arc	Editable field	Horizontal distance along the arc from start point to base point. Available for Line/arc method: Calculate arc offset point .
Offset, Off-set (ground) or Offset (ellipsoid)	Editable field	Offset from base point to offset point. Positive to the right and negative to the left of the arc. Available for Line/arc method: Calculate arc offset point .
Offset point	Selectable list	Point ID of offset point. Available for Line/arc method: Calculate arc base point .

Next step

IF	THEN
Line/arc method: Calculate arc offset point	Calculate accesses Line/Arc Calculation Result .
Line/arc method: Calculate arc base point	Calculate accesses Line/Arc Calculation Result .

Centre of Arc Result/
Line/Arc Calculation
Result,
Result page

The result panels for base point and offset point are similar.

Refer to paragraph "38.7.3 Calculate Line Offset Point and Calculate Line Base Point" for information on softkeys.

Description of fields

Field	Option	Description
Point ID	Editable field	The identifier for the COGO point depending on the point ID template configured for GS / TS in ID Templates .
Height or Local ellipsoid height	Editable field	The height of the start point of the arc is suggested. A height value to be stored with the calculated point can be typed in.
Arc radius	Display only	Computed radius of arc.
Arc length	Display only	Computed length of arc.

Field	Option	Description
Bearing to offset point	Display only	Bearing of offset point from base point to offset point. Available for Line/arc method: Calculate arc offset point.
Offset point	Display only	Point ID of offset point. Available for Line/arc method: Calculate arc base point.
Distance along arc, Distance along arc (ground) or Distance along arc (ellipsoid)	Display only	Horizontal distance along the arc from start point to base point. Available for Line/arc method: Calculate arc offset point.
Offset, Offset (ground) or Offset (ellipsoid)	Display only	Offset from base point to offset point. Positive to the right and negative to the left of the line. Available for Line/arc method: Calculate arc offset point.

Next step

On the **Code** page, type in a code if desired.

On the **3D viewer** page, the arc and the new point is shown.

Store stores the result

38.7.3

Calculate Line Offset Point and Calculate Line Base Point

Diagram

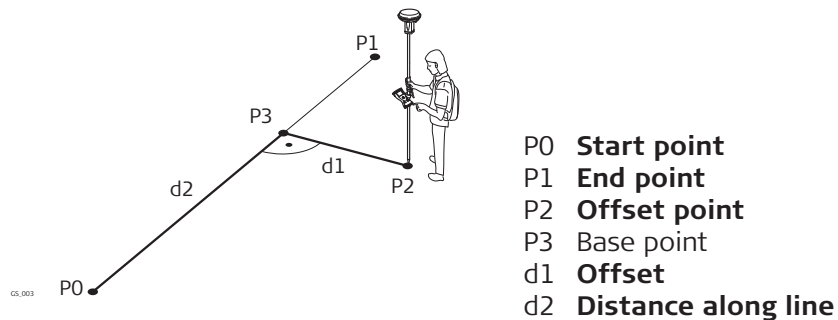

Line management is not available for COGO line calculations.

Create Line, Input page



Key	Description
OK	To change to the second layer of editable fields.
Inverse	To calculate the values for the distance and the offset from two existing points. Available if Azimuth or Horizontal distance is highlighted.
Last Inv	To select the values for the distance and the offset from previous COGO inverse calculations. Available if Azimuth or Horizontal distance is highlighted.
Meas app	To measure a point manually for the COGO calculation. Available if Start point or End point is highlighted.
Page	To change to another page on this panel.
Fn Settings	To configure the COGO app.
Fn Modify	To modify the values manually. Available if, Azimuth or Horizontal distance is highlighted.

Description of fields

Field	Option	Description
Create line using		The method by which the line is defined.
	2 points	Uses two known points to define the line.
	Point, bearing & distance	Defines the line using a known point, a distance and an azimuth of the line.
Start point	Selectable list	The start point of the line.
End point	Selectable list	The end point of the line. Available for Create line using: 2 points .
Azimuth	Editable field	The azimuth of the line. Available for Create line using: Point, bearing & distance .
Horizontal distance, Horizontal distance (ground) or Horizontal distance (ellipsoid)	Editable field	The horizontal distance from the start point to the end point of the line. Available for Create line using: Point, bearing & distance .

Next step

OK accesses **Calculation Input**.

Calculation Input, Input page

Description of fields

Field	Option	Description
Distance along line, Distance along line (ground) or Distance along line (ellipsoid)	Editable field	Available for Create line using: Calculate line offset point . Horizontal distance from start point to base point.
Offset, Off-set (ground) or Offset (ellipsoid)	Editable field	Available for Create line using: Calculate line offset point . Offset from base point to offset point. Positive to the right and negative to the left of the line.
Offset point	Selectable list	Available for Create line using: Calculate line base point . The offset point.

Next step

Calculate accesses **Line/Arc Calculation Result**.

Line/Arc Calculation Result, Result page

The result panels for base point and offset point are similar. The explanations given for the softkeys are valid for the **Result** page.

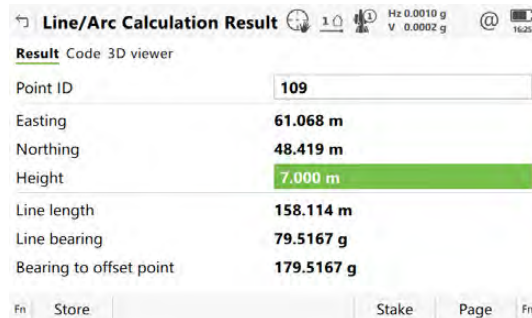

Key	Description
Store	To store the result.
Stake	To access the Stakeout app and stake out the calculated COGO point.
Page	To change to another page on this panel.
Fn Coord	To view other coordinate types.
Fn Ell Ht and Fn Height	To change between the ellipsoidal and the orthometric height. Available for local coordinates.
Fn Tools	Refer to "36 Apps - General".

Description of fields

Field	Option	Description
Point ID	Editable field	The identifier for the COGO point depending on the point ID template configured for GS points / TS points in ID Templates .
Height or Local ellipsoid height	Editable field	The height of the start point of the line is suggested. A height value to be stored with the calculated point can be typed in.
Offset point	Display only	Point ID of offset point. Available for Create line using: Calculate line base point .
Distance along line, Distance along line (ground) or Distance along line (ellipsoid)	Display only	Horizontal distance from start point to base point. Available for Create line using: Calculate line base point .
Offset, Offset (ground) or Offset (ellipsoid)	Display only	Offset from base point to offset point. Positive to the right and negative to the left of the line. Available for Create line using: Calculate line base point .
Line length	Display only	Length of line from start point to end point.
Line bearing	Display only	Bearing of line from start point to end point.
Bearing to offset point	Display only	Bearing of offset point from base point to offset point.

Next step

On the **Code** page, type in a code if desired.

On the **3D viewer** page, the line and the new point is shown.

Store stores the result.

38.7.4

Segment an Arc

Exceptions to line calculation segmentation

The arc segmentation and the functionality of all panels and fields are similar to those for line segmentation. Refer to "38.7.5 Segment a Line"

New field and option in Define Arc Segmentation

Field	Option	Description
Method	Delta angle	To divide the arc by an angular value.
Delta angle	Editable field	The angular value by which new points are defined on the arc.

Diagram

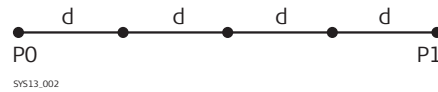

Line divided by **Method: Number of segments**

P0 **Start point**

P1 **End point**

d Equally spaced segments result from dividing a line by a certain number of points.

Line divided by **MethodSegment length**

P0 **Start point**

P1 **End point**

d1 **Segment length**

d2 Remaining segment

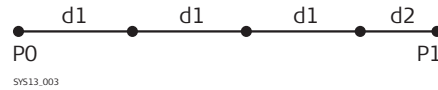

For a description of the **Create Line, Input** page, refer to "38.7.3 Calculate Line Offset Point and Calculate Line Base Point".

Define Line Segmentation

Description of fields

Field	Option	Description
Method	Selectable list	How the line is divided. Depending on the selection, the following fields are editable or display only fields.
Line length	Display only	Calculated line length between the selected Start point and End point .
Number of segments	Editable field or display only	For Method: Number of segments type in the number of segments for the line. For Method: Segment length this field indicates the calculated number of segments. This method can result in a remaining segment.
Segment length	Editable field or display only	For Method: Number of segments this field is the calculated length of each segment. For Method: Segment length type in the required segment length.
Last segment	Display only	Available for Method: Segment length . The length of the remaining segment.
Starting point ID	Editable field	The point ID to be assigned to the first new point on the line. The selected point ID templates from ID Templates are not applied.
Point ID increment	Editable field	Is incremented numerically for the second, third, and so on, point on the line.

Next step

Calculate calculates the coordinates of the new points. The heights are computed along the line assuming a linear slope between **Start point** and **End point**.

On the **3D viewer** page, the known points defining the line and those points created on the line are shown.

38.8

COGO Calculation - Shift, Rotate & Scale

38.8.1

Selecting the Shift, Rotate & Scale Method and the Points to be Moved

Access

Select **Shift, rotate & scale** from the **COGO** menu.

COGO Shift, Rotate, Scale

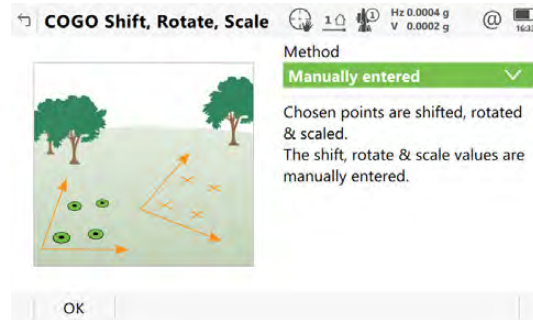

Key	Description
OK	To select a method and to continue with the subsequent panel.

Description of the Shift, Rotate & Scale methods

Shift, Rotate & Scale methods	Description
Manually entered	<p>Applies shifts and/or rotation and/or scale to one or several known points. The values for shifts and/or rotation and/or scale are typed in manually.</p> <p>Elements that must be known are</p> <ul style="list-style-type: none"> • the coordinates of the points to be shifted, rotated and/or scaled. They must be stored in the job. • the shift values. They can be defined as: the direction of Easting, Northing and Height, or as an azimuth and a grid distance, or as shift from one point to another. • the rotation value. It can be defined by a point as rotation centre plus a rotation or by an existing and new azimuth. • the scale. It is only applied to the position, not to the height. <p>Points with full coordinate triplets, position only points and height only points can be used.</p>

Shift, Rotate & Scale methods	Description
Matching points	<p>Applies shifts and/or rotation and/or scale to one or several known points. The shifts and/or rotation and/or scale are calculated from selected points using a 2D Helmert transformation.</p> <p>Elements that must be known are</p> <ul style="list-style-type: none"> the coordinates of at least two matching points for the calculation of the shifts and/or rotation and/or scale. the coordinates of the points to be shifted, rotated and/or scaled. They must be stored in the job. <p>Points with full coordinate triplets, position only points and height only points can be used.</p> <p>The number of pairs of points matched determines whether the shift, rotation and scale values are computed. For only one point, only shifts are calculated, rotation and scale are not.</p>

Next step

OK accesses **Point Selection** which is the same for **Method: Manually entered** and **Method: Matching points**.

Point Selection

Listed are points which have been selected for shifting, rotating and/or scaling.

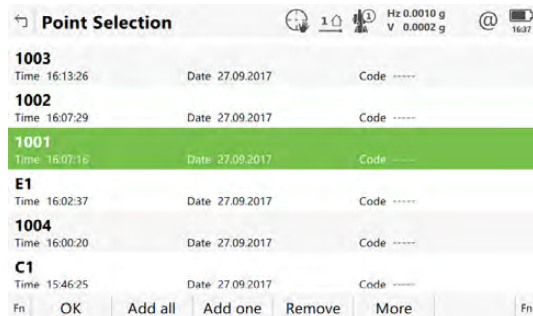

Key	Description
OK	To perform the shift, rotation and scale calculation and to continue with the subsequent panel. Calculated COGO points are not yet stored.
Add all	To add all points from the job to the list. Selected sort and filter settings apply. OK adds all displayed points to the list in Point Selection and returns to that panel.
Add one	To add one point from the job to the list. Selected sort and filter settings apply. OK adds the currently highlighted point to the list in Point Selection and returns to that panel.

Key	Description
Remove	To remove the highlighted point from the list. The point itself is not deleted.
More	To display information about the codes if stored with any point, the time and the date of when the point was stored and the 3D coordinate quality and the class.
Fn Remove all	To remove all points from the list. The points themselves are not deleted.
Fn Range	To define a range of points from the job to be added to the list.

Next step

For **Method:Manually entered:**

OK accesses **Computed Parameters**. Refer to "38.8.2 Manually Entered".

For **Method:Matching points:**

OK accesses **Match Common Pts (%d)**. Refer to "38.8.3 Matching Points".

Choose Pts by Pt ID Range

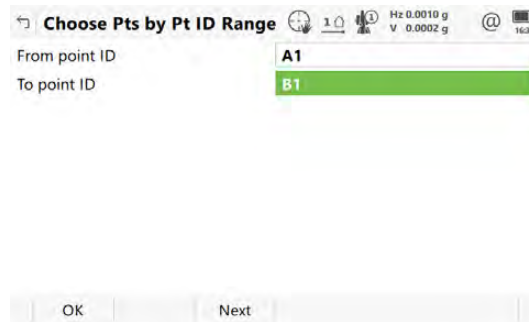

Key	Description
OK	To add the points within the selected range to the list in Point Selection . Returns to the panel from where this panel was accessed.
Next	To add the points within the selected range to the list in Point Selection without quitting this panel. Another range of point IDs can be selected.

Description of fields

Field	Option	Description
From point ID and To point ID	Editable field	<ul style="list-style-type: none"> Numeric point IDs in both fields: Points with numeric point IDs falling within the range are selected. Example: From point ID: 1, To point ID: 50 Selected are point IDs 1, 2, 3, 4, 5, 6, 7, 8, 9, 10... 49, 50 as well as 001, 01, 0000045, ... Not selected are point IDs 100,200,300, ...

Field	Option	Description
		<ul style="list-style-type: none"> Alphanumeric point IDs in both fields: The left-most character of both entries is used as the basis for the range. The standard ASCII numerical range is used. Points with alphanumeric point IDs falling within the range are selected. Example: From point ID: a9, To point ID: c200 Selected are point IDs a, b, c, aa, bb, cc, a1, b2, c3, c4, c5, a610, ... Not selected are point IDs d100, e, 200, 300, tzz ...

Next step

Select a range of points.

OK returns to **Point Selection**.

Diagram

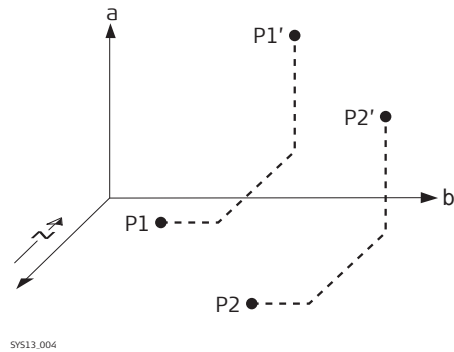

Shift

- a Height
- b Easting
- P1 Known point
- P1' Shifted point
- P2 Known point
- P2' Shifted point

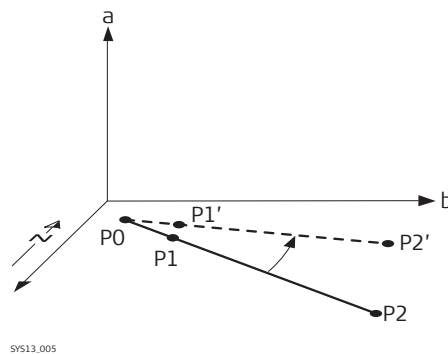

Rotation

- a Height
- b Easting
- P0 **Rotation point**
- P1 Known point
- P1' Rotated point
- P2 Known point
- P2' Rotated point

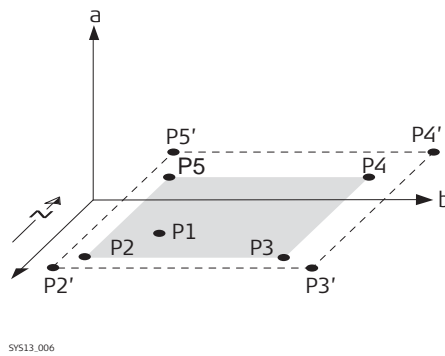

SYS13_006

Scale

- a Height
- b Easting
- P1 **Rotation point**, can be held fixed, all other points are then scaled from here
- P2 Known point
- P2' Scaled point
- P3 Known point
- P3' Scaled point
- P4 Known point
- P4' Scaled point
- P5 Known point
- P5' Scaled point

38.8.2

Manually Entered

Computed Parameters,
Shift page

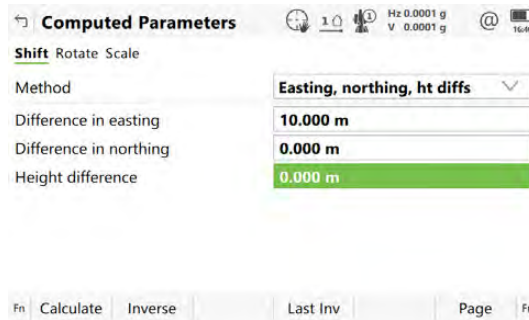

Key	Description
Calculate	To perform the shift, rotation and scale calculation and to continue with the subsequent panel. Calculated COGO points are not yet stored.
Inverse	To calculate the amount of shift in Easting, Northing and height from two existing points. Available if Azimuth, Horizontal distance, Difference in easting, Difference in northing or Height difference is highlighted.
Last Inv	To select the value for the shift from previous COGO inverse calculations. Available if Azimuth, Horizontal distance, Difference in easting, Difference in northing or Height difference is highlighted.
Meas app	To measure a point manually for the COGO calculation. Available for Method: Use 2 points if From or To is highlighted.
Page	To change to another page on this panel.
Fn Settings	To configure the COGO app. Refer to "38.3 Configuring COGO".
Fn Modify	To modify the values manually. Available if Azimuth, Horizontal distance, Difference in easting, Difference in northing or Height difference is highlighted.

Description of fields

Field	Option	Description
Method		The method by which the shift in Δ Easting, Δ Northing and Δ Height is determined.
	Easting, northing, ht diffs	Defines the shift using coordinate differences.
	Bearing, distance & height	Defines the shift using an azimuth, a distance and a height difference.
	Use 2 points	Computes the shift from the coordinate differences between two known points.
From	Selectable list	Available for Method: Use 2 points . The point ID of the first known point for calculating the shift.
To	Selectable list	Available for Method: Use 2 points . The point ID of the second known point for calculating the shift.
Azimuth	Editable field	Available for Method: Bearing, distance & height . The azimuth defines the direction of the shift.
Horizontal distance, Horizontal distance (ground) or Horizontal distance (ellipsoid)	Editable field	Available for Method: Bearing, distance & height . The amount of shift from the original point to the calculated COGO points.
Difference in easting	Editable field or display only	The amount of shift in East direction.
Difference in northing	Editable field or display only	The amount of shift in North direction.
Height difference	Editable field or display only	The amount of shift in height.

Next step

Page changes to the **Rotate** page.

Computed Parameters, Rotate page

The softkeys are the same as on the **Shift** page.

Description of fields

Field	Option	Description
Method		The method by which the rotation angle is determined.

Field	Option	Description
	User entered	The rotation can be manually typed in.
	Computed	The rotation is calculated as New azimuth minus Existing azimuth .
Rotation point	Selectable list	The point around which all points are rotated.
Existing azimuth	Editable field	Available for Method: Computed . A known direction before rotating.
New azimuth	Editable field	Available for Method: Computed . A known direction after rotating.
Rotation	Editable field or display only	The amount by which the points are rotated.

Next step

Page changes to the **Scale** page.

Computed Parameters, Scale page

The softkeys are the same as on the **Shift** page.

Description of fields

Field	Option	Description
Method		The method by which the scale factor is determined.
	User entered	The scale factor can be manually typed in.
	Computed	The scale factor is calculated as New distance divided by Existing distance .
Existing distance	Editable field	Available for Method: Computed . A known distance before scaling. This value is used for calculating the scale factor.
New distance	Editable field	Available for Method: Computed . A known distance after scaling. This value is used for calculating the scale factor.
Scale	Editable field or display only	The scale factor used in the calculation.
Scale from point	Check box	When this box is ticked: Scale is applied to the coordinate difference of all points relative to Rotation point selected on the Rotation page. The coordinates of Rotation point do not change. When this box is not ticked: Scaling is performed by multiplying the original coordinates of the points by Scale .

Next step

Calculate performs the shift, rotation and scale calculation and accesses **Shift, Rotate, Scale Results**.

Shift, Rotate, Scale Results, General page

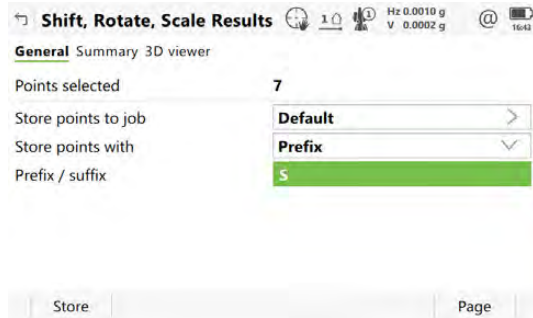

Key	Description
Store	To store the results and continue with the next panel.
Page	To change to another page on this panel.

Description of fields

Field	Option	Description
Points selected	Display only	The number of selected points having been shifted, rotated and/or scaled.
Store points to job	Selectable list	The calculated COGO points are stored in this job. The original points are not copied to this job.
Store points with	Original point IDs	Stores the points with the original point IDs.
	Prefix	Adds the setting for Store points with in front of the original point IDs.
	Suffix	Adds the setting for Store points with at the end of the original point IDs.
Prefix / suffix	Editable field	The identifier with up to four characters is added in front of or at the end of the ID of the calculated COGO points.

Next step

IF	THEN
the used parameters are to be viewed	Page accesses Shift, Rotate, Scale Results, Summary page.
the calculated COGO points are to be stored	Store accesses Shift, Rotate, Scale Results, Result page. Refer to paragraph "Shift, Rotate, Scale Results, Result page".

Description of fields

Field	Option	Description
Number of new points	Display only	Number of new points created.
Number of skipped points	Display only	Number of points which were skipped either due to not being able to convert coordinates, or points with identical point IDs already in the Store points to job .

Next step

On the **3D viewer** page, original points are displayed in grey, calculated COGO points are displayed in black.

OK returns to **COGO Shift, Rotate, Scale**.

38.8.3

Matching Points

Match Points

This panel provides a list of points chosen from the job. The points are used for the determination of the 2D Helmert transformation. The number of points matched is indicated in the title, for example (2). Unless there is no pair of matching points in the list all softkeys are available.

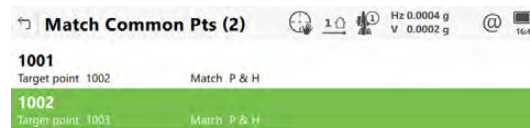

Fn Calculate New Edit Delete Match Resid Fn

Key	Description
Calculate	To confirm the selections, compute the transformation and continue with the subsequent panel.
New	To match a new pair of points. This pair is added to the list. A new point can be manually measured. Refer to paragraph "Choose Matching Points or Edit Matching Points".
Edit	To edit the highlighted pair of matched points.
Delete	To delete the highlighted pair of matched points from the list.
Match	To change the type of match for a highlighted pair of matched points.
Resid	To display a list of the matched points used in the transformation calculation and their associated residuals. Refer to paragraph "Fix Parameters".
Fn Param	To define the parameters to be fixed in the 2D transformation.

Description of metadata

Metadata	Description
-	The point ID of the points of origin for the calculation of the shifts and/or rotation and/or scale.
Target point	The point ID of the target points for the calculation of the shifts and/or rotation and/or scale.
Match	The type of match to be made between the points. This information is used in the transformation calculation. Position & Height , Position only , Height only or None . None removes matched common points from the transformation calculation but does not delete them from the list. This option can be used to help improve residuals.

Next step

IF	THEN
the transformation is to be computed	Calculate. The calculated shift, rotation and scale values are displayed in Point Selection . They cannot be edited. The remaining functionality of the calculation is similar to shift, rotate & scale (manual). Refer to "38.8 COGO Calculation - Shift, Rotate & Scale".
a pair of points is to be matched or edited	New or Info.
parameters for the transformation are to be fixed	Fn Param.

Choose Matching Points or Edit Matching Points



Key	Description
OK	To confirm the selections.
Meas app	To measure a point manually for the COGO calculation. Available if Source point or Target point is highlighted.

Description of fields

Field	Option	Description
Source point	Selectable list	A point of origin for the calculation of the shifts and/or rotation and/or scale.

Field	Option	Description
Target point	Selectable list	A target point for the calculation of the shifts and/or rotation and/or scale.
Match type		The type of match to be made between the points selected.
	Pos & height	Position and height
	Pos only	Position only
	Height only	Height only
	None	None

Fix Parameters

The settings on this panel define the parameters to be used in the transformation.

IF the value for a field is	THEN the value for this parameter is
-----	calculated.
any number	fixed to that value.

Description of fields

Field	Option	Description
Difference in easting	Editable field	Shift in Easting direction.
Difference in northing	Editable field	Shift in Northing direction.
Height difference	Editable field	Shift in Height direction.
Rotation	Editable field	Rotation around the vertical axis.
Scale	Editable field	Scale factor.

Next step

IF	AND	THEN
a field displays -----	the parameter must be fixed to a value	highlight the field. Enter the value of the parameter. Fix.
a field displays a value	the parameter must be calculated	highlight the field. Adjust.
all parameters are configured	-	OK to return to Match Points.

38.9

COGO Calculation - Area Division

38.9.1

Selecting the Division Method

Description

The COGO calculation area division divides an object by a defined line, by percentage or by size.

Elements that must be known for the calculation depend on the division method. At least three points are required to form an object.

The coordinates of the known points

- can be taken from the job.
- can be measured during the COGO calculation.
- can be entered.

Access

Select **Area division** from the **COGO** menu.

COGO Area Division

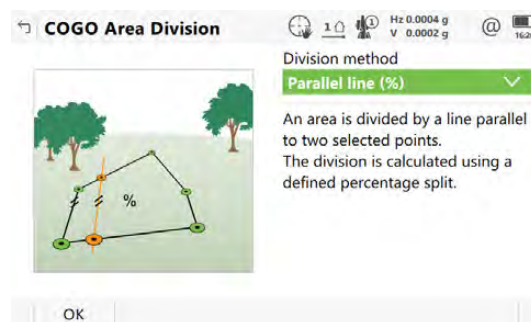

Key	Description
OK	To select a method and to continue with the subsequent panel.

Description of the division methods

Division method	Description
Parallel line (%)	The border is parallel to a line defined by two points. The division is calculated using a defined percentage split.
Parallel line (area)	The border is parallel to a line defined by two points. The division is calculated using a defined size.
Parallel line (line)	The border is parallel to a line defined by two points. The division is calculated by defining the position of the dividing line.
Perpendicular line (%)	The border is perpendicular to a line defined by two points. The division is calculated using a defined percentage split.
Perpendicular line (area)	The border is perpendicular to a line defined by two points. The division is calculated using a defined size.

Division method	Description
Perpendicular line (line)	The border is perpendicular to a line defined by two points. The division is calculated by defining the position of the dividing line.
Swing line (%)	The border is a line rotated around a rotation point by an azimuth. The division is calculated using a defined percentage split.
Swing line (area)	The border is a line rotated around a rotation point by an azimuth. The division is calculated using a defined size.

Elements required

Divide by	Using		Elements required	
Line	Parallel line	Through a point	<ul style="list-style-type: none"> Two points defining the line One point on the dividing line 	
		By a distance	<ul style="list-style-type: none"> Two points defining the line Distance 	
	Perpendicular line	Through a point	<ul style="list-style-type: none"> Two points defining the line One point on the dividing line 	
		By a distance	<ul style="list-style-type: none"> Two points defining the line Distance 	
	Percentage	Parallel line	-	<ul style="list-style-type: none"> Percentage size of new area Two points defining the line
			Perpendicular line	-
Swing line		Rotation point	<ul style="list-style-type: none"> Percentage size of new area Rotation point of the swing line 	
Area	Parallel line	-	<ul style="list-style-type: none"> Size of new area Two points defining the line 	
		Perpendicular line	-	<ul style="list-style-type: none"> Size of new area Two points defining the line
	Swing line	Rotation point	<ul style="list-style-type: none"> Size of new area Rotation point of the swing line 	

Diagram

The diagrams show the division methods. Some diagrams apply to several division methods.

Division method	Using	Devide by	Shift by
1.	Parallel Line	Defined Line	Distance
2.	Parallel Line	Percentage	-
3.	Parallel Line	Area	-

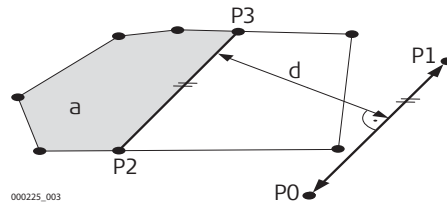

P0 **Point A** of defined line
 P1 **Point B** of defined line
 P2 First new COGO point
 P3 Second new COGO point
 d **Horizontal distance**
 a **Area left of line**

Division method	Using	Devide by	Shift by
1.	Perpendic Line	Defined Line	Distance
2.	Perpendic Line	Percentage	-
3.	Perpendic Line	Area	-

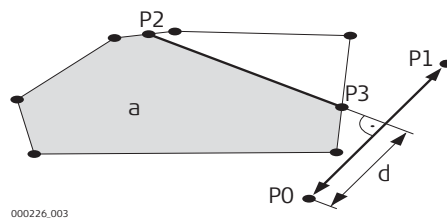

P0 **Point A** of defined line
 P1 **Point B** of defined line
 P2 First new COGO point
 P3 Second new COGO point
 d **Horizontal distance**
 a **Area left of line**

Division method	Using	Devide by	Shift by
1.	Parallel Line	Defined Line	Through Point

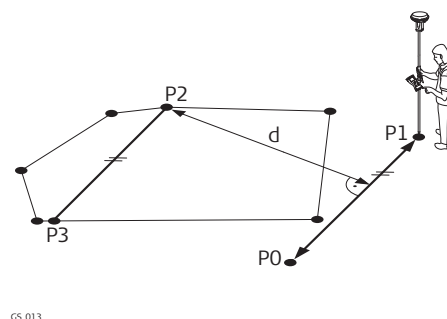

P0 **Point A** of defined line
 P1 **Point B** of defined line
 P2 **Through point**; in this case it is a known point of the existing border
 P3 New COGO point
 d **Horizontal distance**

Division method	Using	Devide by	Shift by
1.	Perpendic Line	Defined Line	Through Point

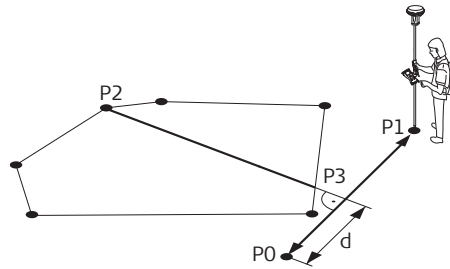

GS_014

- P0 **Point A** of defined line
- P1 **Point B** of defined line
- P2 **Through point**; in this case it is a known point of the existing border
- P3 New COGO point
- d **Horizontal distance**

Division method	Using	Devide by	Shift by
1.	Swing Line	Percentage	-
2.	Swing Line	Area	-

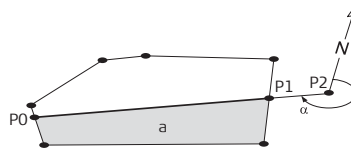

SP13_007

- P0 First new COGO point
- P1 Second new COGO point
- P2 **Rotation point**
- α **Azimuth**
- a **Area left of line**

38.9.2

Choosing an Object to be Divided

Choose Area Object

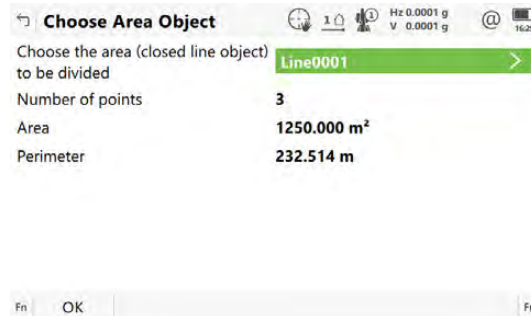

Key	Description
OK	To accept the changes and access the subsequent panel.
Fn Settings	To configure the COGO app.

Description of fields

Field	Option	Description
Choose the area (closed line object) to be divided	Selectable list	To select the object to be divided.

Field	Option	Description
Number of points	Display only	Number of points forming the object.
Area	Display only	The size of the selected object.
Perimeter	Display only	The perimeter of the object.

Next step

OK accesses **Define How to Divide Area**.

38.9.3

Dividing an Area

Define How to Divide Area, Input page

After each change of parameters on this panel, the values in the display only fields are recalculated and updated.

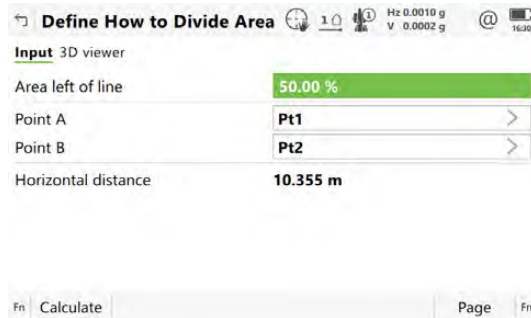

Key	Description
Calculate	To perform the area division and to continue with the subsequent panel. Calculated COGO points are not yet stored.
Inverse	To calculate the value for the distance from two existing points. Available if Horizontal distance is highlighted.
Size and %	To display the size and the percentage of the divided areas.
Last Inv	To select the value for the distance from previous COGO inverse calculations. Available if Horizontal distance is highlighted.
Meas app	To measure a point manually for the COGO calculation. Available if Point A , Point B , Rotation point or Through point is highlighted.
Page	To change to another page on this panel.
Fn Settings	To configure the COGO app.

Description of fields

Field	Option	Description
Area left of line	Editable field	For dividing by percentage or area. The size must be typed either in % or in m ² .

Field	Option	Description
		When dividing the area using a parallel or perpendicular line, a reference line is defined by Point A and Point B . The direction of the new dividing line is always the same as the direction of the reference line. The direction of a perpendicular line is the same as the reference line rotated 90° anticlockwise. The divided area is always to the left of the new dividing line.
		When dividing an area using a swing line, the direction of the new dividing line is defined by the Rotation point and the Azimuth . The divided area is always to the left of the new dividing line.
	Display only	For dividing by a line. The size of the divided area is calculated and displayed.
Point A	Selectable list	The first point of the line which is used as the reference for a new parallel or perpendicular border.
Point B	Selectable list	The second point of the line which is used as the reference for a new parallel or perpendicular border.
Shift		Available for dividing by a line.
	By distance	The new border runs in a certain distance from the line defined by Point A and Point B .
	Through point	The new border runs through a point defined in Through point .
Through point	Selectable list	Available for Shift: Through point . The point through which the new border runs.
Rotation point	Selectable list	Available for using a swing line. The point around which the new border rotates by Azimuth .
Azimuth	Display only	Available for using a swing line. The angle of the new border from Rotation point to the new COGO point.
Horizontal distance, Horizontal distance (ground) or Horizontal distance (ellipsoid)	Display only or editable field	The distance from the line defined by Point A and Point B to the new border.

Next step

Calculate performs the area division and accesses **Area Division Result**.

Area Division Result, Result page

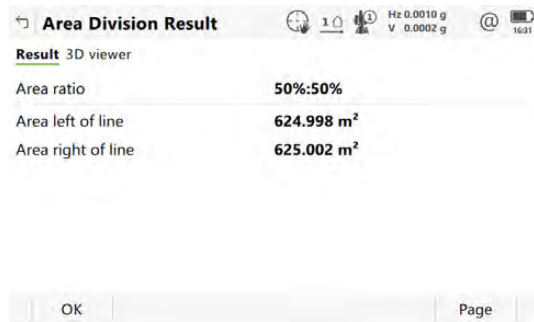

Key	Description
OK	To accept the calculation and to continue with the subsequent panel. Calculated COGO points are not yet stored.
Page	To change to another page on this panel.

Description of fields

Field	Option	Description
Area ratio	Display only	The ratio of the size of the two areas in percent.
Area left of line	Display only	The size of the first area in m ² .
Area right of line	Display only	The size of the second area in m ² .

Next step

On the **3D viewer** page, the points defining the area and the calculated COGO points are shown in black.

OK accesses **Area Divisions Results**.

Area Divisions Results, Result 1/ Result 2 page

The coordinates of the intersection points of the new border with the original area are displayed.

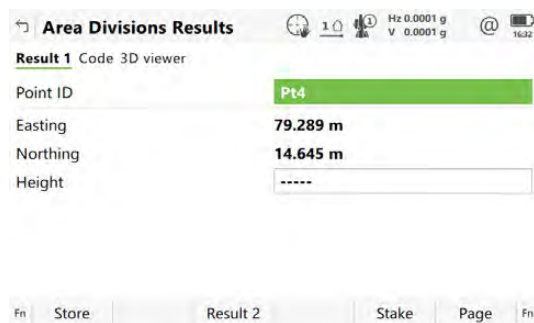

Key	Description
Store	To store the two results and to return to Choose Area Object once both points are stored.

Key	Description
Result 1 or Result 2	To view the first and second result.
Stake	To access the Stakeout app and stake out the calculated COGO point.
Page	To change to another page on this panel.
Fn Tools	Refer to "37 Apps - The Toolbox".

Next step

On the **Code** page, type in a code if desired.

On the **3D viewer** page, the points defining the area and the points of the new border are shown in black.

Store stores the results.

38.10

COGO Calculation - Angle Method

Access

Select **Angle** from the **COGO** menu.

COGO Angle, Input page

For all point fields, the 3D viewer can be used to select the desired point.

To type in coordinates for a known point open a selectable list. Press **New** to create a point.

Key	Description
Calculate	To calculate the result.
Meas app	To measure a point manually for the COGO calculation.
Page	To change to another page on this panel.

Description of fields

Field	Option	Description
From point	Selectable list	The backsight point.
At point	Selectable list	The point of intersection of the backsight and foresight direction.
To point	Selectable list	The foresight point.

Next step

Calculate calculates the result and accesses **COGO Angle, Results** page.

COGO Angle, Results page

Key	Description
OK	To accept changes and return to the Input page.
Page	To change to another page on this panel.

Description of fields

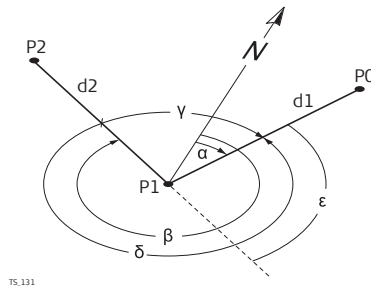

- α Azimuth at-from
- β Azimuth at-to
- γ Deflection angle
- δ Angle right
- ϵ Angle left
- P0 Point ID
- P1 At point
- P2 To point
- d1 Horiz distance at-from
- d2 Horiz distance at-to

38.11

COGO Calculation - Horizontal Curve Method

Access

Select **Horizontal curve** from the **COGO** menu.

Horiz Curve Calculator, Input page

For all point fields, the 3D viewer can be used to select the desired point. To type in coordinates for a known point open a selectable list. Press **New** to create a point.

Key	Description
Calculate	To calculate the result.
Inverse	To calculate the values for a distance and an angle from two existing points. Available when a distance field or an angle field is highlighted.
Last Inv	To recall previous results from COGO inverse calculations. Available when a distance field or an angle field is highlighted.
Meas app	To measure a point manually for the COGO calculation. Available if Start point , Second point or End point is highlighted.
Page	To change to another page on this panel.

Description of fields

Field	Option	Description
Method	Selectable list	The horizontal curve can either be defined by three points or by two parameters.
Parameter 1, Parameter 2		Select which parameters are known. Available for Method: 2 parameters .
	Radius	Radius of the curve.
	Delta angle	Angle in the radius point.
	DOC - Arc	The degree of curve defines the sharpness or flatness of the curve. Degree of curvature in arc definition. The central angle subtended by one station of circular arc. Used in highway design. SI units: 1 station = 20 m English system: 1 station = 100 ft

Field	Option	Description
	DOC - Chord	The degree of curve defines the sharpness or flatness of the curve. Degree of curvature in chord definition. The central angle subtended by one station length of chord. Used in railway design.
	Arc length	Total length of the circular curve from start point to end point measured along its arc.
	Tangent	Length of the tangent from the tangent point to the point of intersection.
	External secant	The distance from the point of intersection to the midpoint of the curve. The external distance bisects the interior angle at the point of intersection.
	Mid ordinate	The distance from the midpoint of the curve to the midpoint of the long chord. The extension of the middle ordinate bisects the central angle.
	Delta angle	The angle where the two tangents intersect. The angle between the tangents is also equal to the angle at the centre of the curve

Next step

Calculate calculates the result and accesses **Horiz Curve Calculator, Results**.

Horiz Curve Calculator,
Results page

Key	Description
OK	To accept changes and return to Horiz Curve Calculator, Input page.
Page	To change to another page on this panel.

Description of fields

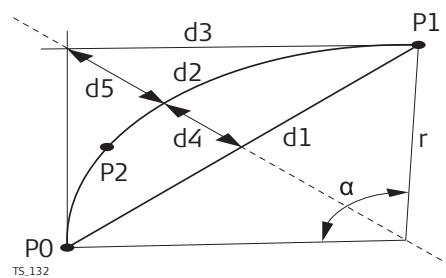

- α **Delta angle**
- P0 **Start point**
- P1 **End point**
- P2 **Second point**
- r **Radius**
- d1 **Chord length**
- d2 **Arc length**
- d3 **Tangent**
- d4 **Mid ordinate**
- d5 **External secant**

Horiz Curve Calculator,
Areas page

Key	Description
OK	To accept changes and return to the Input page.
Page	To change to another page on this panel.

Description of fields

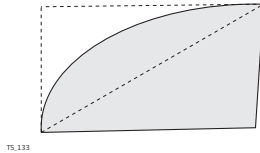

**Sec
tor**

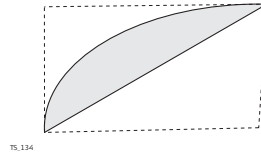

**Seg
me
nt**

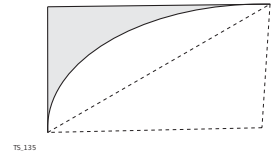

**Fil-
let**

Next step

On the **3D viewer** page, original points are displayed in grey. The calculated curve through the defined COGO points is displayed in black.

38.12

COGO Calculation - Triangle Method

Access

Select **Triangle** from the **COGO** menu.

COGO Triangle, Input page

For all point fields, the 3D viewer can be used to select the desired point. To type in coordinates for a known point open a selectable list. Press **New** to create a point.

Key	Description
Calculate	To calculate the result.
Inverse	To calculate the values for a distance and an angle from two existing points. Available when a distance field or an angle field is highlighted.
Last Inv	To recall previous results from COGO inverse calculations. Available when a distance field or an angle field is highlighted.
Meas app	To measure a point manually for the COGO calculation. Available if Point A , Point B or Point C is highlighted.
Page	To change to another page on this panel.

Description of fields

Field	Option	Description
Method	Selectable list	The triangle can either be defined by three points or by three parameters.
Parameters	Selectable list	Select which combination of angle value and side length are known. Available for Method: 3 parameters .
Side a, Side b, Side c	Editable field	The side lengths of the triangle.
Angle A, Angle C	Editable field	The angle values of the triangle.

Field	Option	Description
Point A, Point B, Point C	Selectable list	The points forming the triangle.

Next step

Calculate calculates the result and accesses **COGO Triangle, Results** page.

COGO Triangle, Results page

Key	Description
OK	To accept changes and return to the Input page.
Result 1 or Result 2	To view the first and second result.
Page	To change to another page on this panel.

Description of fields

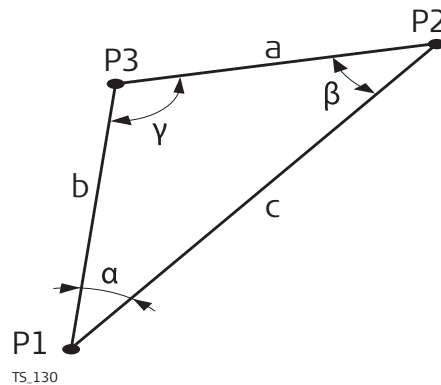

- α **Angle A**
- β **Angle B**
- γ **Angle C**
- P1 **Point A**
- P2 **Point B**
- P3 **Point C**
- a **Side a**
- b **Side b**
- c **Side c**

38.13

Selecting a Result from Previous COGO Inverse Calculations

Description

Azimuths, distances and offsets required within the COGO traverse and intersection calculations can be selected from previously calculated inverse results.

Access

In Traverse or Intersection, highlight **Azimuth**, **Horizontal distance** or **Offset** and press **Last Inv.**

Last Inverse Calculations

All previous COGO inverse calculations stored in the job are displayed, sorted by time with the most recent at the top. This panel consists of three columns. The information displayed can vary. ----- is displayed for unavailable information, for example the **Azimuth** cannot be calculated if a height only point is used.

Key	Description
OK	To return to the previous panel.
View	To view all calculated values for the highlighted COGO inverse calculation. Includes the height difference, the slope distance, the grade and the coordinate differences between the two known points.
Delete	To delete the highlighted COGO inverse calculation.

Key	Description
More	To display other information in the third column.

Description of metadata

Metadata	Description
-	The point ID of the first known point for the COGO inverse calculation.
To	The point ID of the second known point for the COGO inverse calculation.
Azimuth	The direction from the first to the second known point.
Horiz Dist	The horizontal distance between the two known points.
Date and Time	When the COGO inverse calculation was stored.

Next step

Highlight the COGO inverse calculation of which a result is to be taken over.

OK. The relevant result of the highlighted COGO inverse calculation is copied into the field which was initially highlighted on the **Input** page.

38.14

Modifying Values for Azimuths, Distances and Offsets

Description

The values for the azimuth, the distance and the offset required within the COGO traverse and intersection calculation can be mathematically modified.

Access

In Traverse or Intersection, highlight **Azimuth**, **Horizontal distance** or **Offset** and press **Fn Modify**.

Modify Value

On this panel, numbers can be typed in for the multiplication, division, addition and subtraction with the original azimuth, distance or offset value. The standard rules of mathematical operations apply.

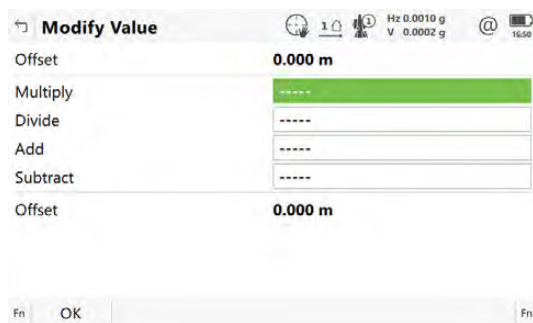

Key	Description
OK	To accept the modified value and to return to the panel from where this panel was accessed. The modified value is copied into the field which was initially highlighted on the Input page.

Description of fields

Field	Option	Description
Azimuth, Horizontal distance or Offset	Display only	The name of the field and the value which was highlighted before accessing Modify Value .
Multiply	Editable field	The number to multiply by. <ul style="list-style-type: none"> • Minimum: -3000 • Maximum: 3000 • ----- multiplies by 1.
Divide	Editable field	The number to divide by. <ul style="list-style-type: none"> • Minimum: -3000 • Maximum: 3000 • ----- divides by 1.
Add	Editable field	The number to be added. <ul style="list-style-type: none"> • For azimuths Minimum: 0 Maximum: Full circle • For distances and offsets Minimum: 0 m Maximum: 30000000 m • ----- adds 0.000.
Subtract	Editable field	The number to be subtracted. <ul style="list-style-type: none"> • For azimuths Minimum: 0 Maximum: Full circle • For distances and offsets Minimum: 0 m Maximum: 30000000 m • ----- subtracts 0.000.
Azimuth, Horizontal distance or Offset	Display only	The modified value for the field in the first line. This field is updated with every mathematical operation. Angles greater than the full circle are reduced accordingly.

Next step

OK accepts the modified value and returns to the panel from where this panel was accessed.

Example: Calculations for an azimuth

Step	Editable field	Value as calculated	Value as displayed
			Azimuth: 250.0000 g
1.	Multiply: 2	500	Azimuth: 100.0000 g
2.	Divide: 3	166.667	Azimuth: 166.6670 g
3.	Add: 300	466.667	Azimuth: 66.6670 g
4.	Subtract: 100	366.667	Azimuth: 366.6670 g

Example: Calculations for a distance

The behaviour for an offset is identical.

Step	Editable field	Value as calculated	Value as displayed
			Horizontal distance: 250.000 m
1.	Multiply: 2	500	Horizontal distance: 500.000 m
2.	Divide: 3	166.667	Horizontal distance: 166.667 m
3.	Add: 300	466.667	Horizontal distance: 466.667 m
4.	Subtract: 100	366.667	Horizontal distance: 366.667 m

39

Determine Coordinate System

39.1

Overview

Description

GNSS measured points are always stored based on the global geocentric datum known as WGS 1984. Most surveys require coordinates in a local grid system. For example, based on a country's official mapping datum or an arbitrary grid system used in a particular area such as a construction site. To convert the WGS 1984 coordinates into local coordinates a coordinate system must be created. Part of the coordinate system is the transformation used to convert coordinates from the WGS 1984 datum to the local datum.

The Determine Coordinate System app allows:

- the parameters of a new transformation to be determined.
- the parameters of an existing transformation to be recomputed.



With one common control point, it is still possible to calculate a Classic 3D transformation, as long as the rotations and the scale parameter are fixed. Such a transformation fits perfectly in the vicinity of the common control point, but is degraded by the distance from that point. This degradation is because the orientation of the local reference frame or any scale factor within the local datum cannot be taken into account.

Requirements to determine a transformation

To determine a transformation it is necessary to have common control points whose positions are known in both WGS1984 coordinates and local coordinates. The more points that are common between datum, the more accurately the transformation parameters can be calculated. Depending on the type of transformation used, details about the map projection, the local ellipsoid and a local geoid model can also be needed.

Requirements for control points

- The control points used for the transformation should surround the area for which the transformation is to be applied. It is not good practice to survey or convert coordinates outside of the area covered by the control points as extrapolation errors can be introduced.
- When a geoid field file, and/or a CPCS field file is used in the determination of a coordinate system, the control points for the calculation must fall within the areas of the field files.

39.2

Selecting the Transformation Method

Description

Determine Coordinate System is the conventional method of determining a coordinate system. Parameters such as the height mode must be set by the user.

One or more control points for both the WGS 1984 and the local datum are needed.

Depending on the number of control points and available information, a One-step, Twostep or Classic 3D transformation can be used.

Access

Select **Create coord sys** from the **Leica Captivate - Home** menu.

Determine Coord System**Description of fields**

Field	Option	Description
Method	Onestep	<p>The type of transformation to be used when determining a coordinate system.</p> <p>Transforms coordinates directly from WGS 1984 to local grid and vice versa without knowledge about the local ellipsoid or the map projection. Procedure:</p> <p>The WGS 1984 coordinates are projected onto a temporary Transverse Mercator Projection. The central meridian of this projection passes through the centre of gravity of the common control points.</p> <p>The results of 1. are preliminary grid coordinates for the WGS 1984 points.</p> <p>These preliminary grid coordinates are matched with the local grid control points. The Easting and Northing shifts, the rotation and the scale factor between these two sets of points are then computed. This process is known as a classic 2D transformation.</p> <p>The height transformation is a single dimension height approximation.</p> <p>Refer to "I Glossary".</p>
	Twostep	<p>Combines the advantages of the Onestep and the Classic 3D transformation. It allows treating position and height separately, but is not restricted to smaller areas. Procedure:</p> <p>The WGS 1984 coordinates of the common control points are shifted closely to the local datum using a given Classic 3D pre-transformation. This Classic 3D transformation is typically a rough transformation valid for the country of the local datum.</p> <p>The coordinates are projected onto a preliminary grid, but this time using the true map projection of the local points.</p> <p>A 2D transformation is applied, exactly as with the Onestep transformation.</p> <p>Refer to "I Glossary".</p>
	Classic 3D	<p>Also known as Helmert transformation. Transforms coordinates from WGS 1984 cartesian to local cartesian coordinates and vice versa. A map projection can then be applied to obtain grid coordinates. As a similarity transformation, it is the most rigorous transformation type and keeps the full geometrical information. Refer to "I Glossary".</p>

Field	Option	Description
	Modify existing	To modify an existing determine coordinate system. Refer to "39.3.3 Modifying a Coordinate System".

Next step

IF the selected method is	THEN
Onestep, Twostep or Classic 3D	OK to access Choose Jobs . Refer to the following paragraph: Choose Jobs .
Modify existing	OK to access Coordinate Systems . Refer to "39.3.3 Modifying a Coordinate System".

Choose Jobs

Key	Description
OK	To confirm the selections and to continue with the subsequent panel.
Fn Settings	To configure the selected coordinate system determination method.

Description of fields

Field	Option	Description
Name	Editable field	A unique name for the coordinate system. The name can be up to 16 characters in length and can include spaces. Input is mandatory.  Entering the name of a coordinate system allows that existing system to be updated.
Job where WGS84 points are stored	Selectable list	The job from which the points with WGS 1984 coordinates are taken.
Job where local points are stored	Selectable list	The job from which the points with local coordinates are taken.

Field	Option	Description
Use one point localisation method	Check box	Number of control points needed: One control point for both the WGS 1984 and the local datum. Transformation to use: <ul style="list-style-type: none"> • Onestep or Twostep when information about the necessary rotations and scale factor is known. • Classic 3D when the rotations are set to zero and the scale factor to one.

Next step

Press **Fn Settings** with **Use one point localisation method** NOT checked to access **Settings**.

39.3

The Normal Method

39.3.1

Configuring the Normal Method

Description

The setting allows options to be set, which are used in the Determine Coordinate System app. These settings are stored within the active working style.

Access

Press **Fn Settings** in **Choose Jobs** with **Use one point localisation method** NOT checked.

Settings, Residuals page

The explanations for the softkeys given here are valid for all pages, unless otherwise stated.

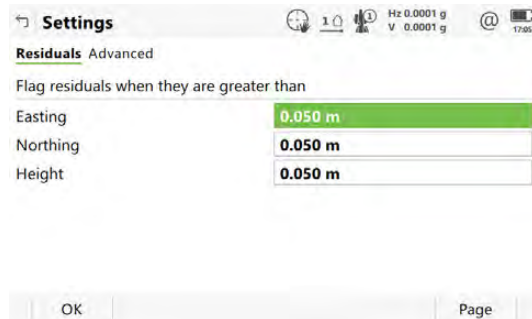

Key	Description
OK	To accept changes and return to the panel from where this panel was accessed.
Page	To change to another page on this panel.

Description of fields

Field	Option	Description
Easting	Editable field	The limit above which Easting residuals are flagged as possible outliers.
Northing	Editable field	The limit above which Northing residuals are flagged as possible outliers.

Field	Option	Description
Height	Editable field	The limit above which Height residuals are flagged as possible outliers.

Next step

Page changes to the **Advanced** page.

Settings, Advanced page

Description of fields

Field	Option	Description
Model	Bursa-Wolf or Molodensky-Badekas	The transformation model to be used. Refer to standard surveying literature for details on the models.
Prompt me to enter fixed transformation parameters	Check box	To configure Classic 3D transformation parameters during the process of calculation.

Next step

OK returns to **Choose Jobs**.

39.3.2

Determining a New Coordinate System

Access

Press **OK** in **Choose Jobs** with **Use one point localisation method** NOT checked.

Choose Height Mode

The screenshot shows a dialog box titled "Choose Height Mode". At the top right, there are system icons for clock, signal strength, battery, and a battery level indicator showing 17:12. The dialog contains three fields: "Transformation name" with the value "22", "Transformation type" with the value "Onestep", and "Height mode" with a dropdown menu showing "Ellipsoidal". At the bottom, there is an "OK" button.

Key	Description
OK	To confirm the selections and to continue with the subsequent panel.

Description of fields

Field	Option	Description
Transformation name	Editable field	A unique name for the transformation. The name can be up to 16 characters in length and include spaces. If a coordinate system is being updated then its name is displayed.

Field	Option	Description
Transformation type	Display only	The type of transformation to be used when determining a coordinate system.
Height mode	Orthometric or Ellipsoidal	The height mode to be used in the determination of a coordinate system. Available when determining a new coordinate system.
	Display only	Available when updating a coordinate system. The height mode shown is the same as the mode used in the existing system.

Next step

OK continues to **Coord System Components**.

Coord System Components

This panel contains different fields, depending on what method was chosen in **Determine Coord System**.

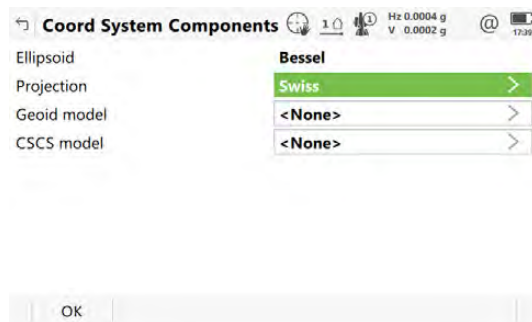

Key	Description
OK	To confirm the selections and to continue with the subsequent panel.

For Onestep

Description of fields

Field	Option	Description
Geoid model	Selectable list	The geoid model to be used in the transformation.
Pre-transformation	Selectable list	For Twostep: The pre-transformation to use for the preliminary 3D transformation.
Ellipsoid	Selectable list	For Twostep and Classic 3D: The ellipsoid to use in the transformation.
	Display only	For Twostep and Classic 3D: The ellipsoid used by a fixed projection when selected in Projection .
Projection	Selectable list	For Twostep and Classic 3D: The projection to use in the transformation.

Field	Option	Description
CSCS model	Selectable list	For Classic 3D: The CSCS model to use in the transformation.

Next step

OK continues to **Matched Points (n)**.

Matched Points (n)

This panel provides a list of points chosen from **Job where WGS84 points are stored** and **Job where local points are stored**. The number of control points matched between both jobs is indicated in the title. Unless there is no pair of matching points in the list all softkeys are available. Refer to "39.3.4 Matching Points: Selecting/ Editing a Pair of Matching Points" for information on how to match points.

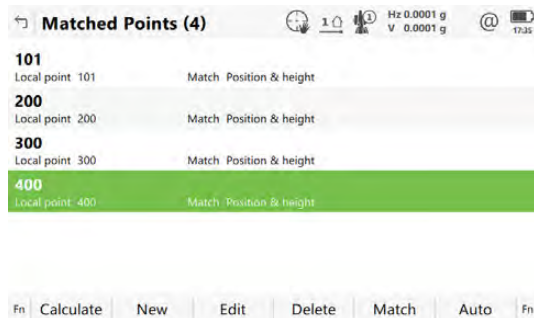

Key	Description
Calculate	To confirm the selections, compute the transformation and continue with the subsequent panel.
New	To match a new pair of points. This pair is added to the list. A new point can be manually occupied. Refer to "Choose Matching Points/Edit Matching Points".
Edit	To edit the highlighted pair of matched points. Refer to "Choose Matching Points/Edit Matching Points".  If a coordinate system to be updated contains a point that was deleted from the job and a new point was created in that job with the same point ID but different coordinates, the coordinates of the old point are still used for the calculation. Pressing Edit to edit a highlighted pair of matched points containing the deleted point, overwrites the coordinates of the old point. The coordinates of the new point are used in the calculation.
Delete	To delete the highlighted pair of matched points from the list.
Match	To change the type of match for a highlighted pair of matched points. Refer to "39.3.4 Matching Points: Selecting/ Editing a Pair of Matching Points".
Auto	To scan both jobs for points that have the same point ID. Points with matching point IDs are added to the list.

Description of metadata

Metadata	Description
-	The point ID of the points chosen from Job where WGS84 points are stored.
Local point	The point ID of the points chosen from Job where local points are stored.
Match	<p>The type of match to be made between the points. This information is used in the transformation calculation.</p> <ul style="list-style-type: none"> For Onestep or Twostep possible options are Position & height, Position only, Height only or None. For Classic 3D, possible options are Position & height or None. <p>None removes matched common points from the transformation calculation but does not delete them from the list. This option can be used to help improve residuals.</p>

Next step

Calculate computes the transformation and continues to **Residuals** or to **Classic 3D Parameters** if **Prompt me to enter fixed transformation parameters** was checked.

Classic 3D Parameters

The settings on this page define the parameters to be used in a Classic 3D transformation. Refer to "I Glossary" for more information about how many transformation parameters are computed, based on the number of points common to both datum.

IF the value for a field is	THEN the value for this parameter will be
-----	calculated.
any number	fixed to that value.

Description of fields

Field	Option	Description
Model	Bursa-Wolf or Moloden-sky-Badekas	The transformation model to be used. Refer to standard surveying literature for details on the models.
Shift dX	Editable field	Shift in X direction.
Shift dY	Editable field	Shift in Y direction.
Shift dZ	Editable field	Shift in Z direction.
Rotation X	Editable field	Rotation around the X axis.
Rotation Y	Editable field	Rotation around the Y axis.
Rotation Z	Editable field	Rotation around the Z axis.
Scale	Editable field	Scale factor.

Next step

IF	AND	THEN
a field displays -----	the parameter must be fixed to a value	highlight the field. Fix. Enter the value of the parameter.
a field displays a value	the parameter must be calculated	highlight the field. Adjust.
all parameters are configured	-	OK computes the transformation and continues to Residuals .

Residuals

Displays a list of the matched points used in the transformation calculation and their associated residuals.

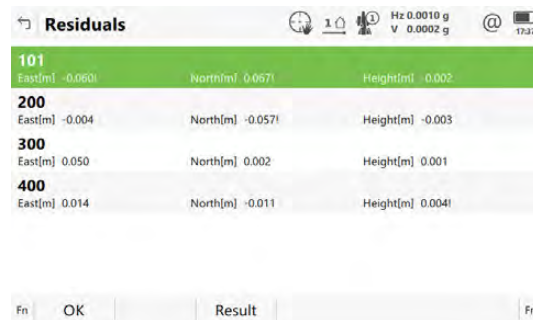

Key	Description
OK	To accept the residuals and to continue with the subsequent panel.
Result	To view results of the transformation. Refer to "39.3.5 Transformation Results for Onestep and Twostep".

Description of metadata

Metadata	Description
-	The point ID of the points chosen from Job where WGS84 points are stored .
East	The Easting residual. If positions are not used in the transformation calculation then ----- is displayed.
North	The Northing residual. If positions are not used in the transformation calculation then ----- is displayed.
Height	The Height residual. If heights are not used in the transformation calculation then ----- is displayed.
!	Indicates residuals that exceed the residual limit defined in Settings, Residuals page.
!	Indicates the largest residual in East, North and Height .

Next step

IF the residuals are	THEN
unacceptable	ESC returns to Matched Points (n) . Matched points can be edited, deleted or temporarily removed from the list and the transformation recalculated.
acceptable	OK continues to Store Coordinate System .

Store Coordinate System, Summary page

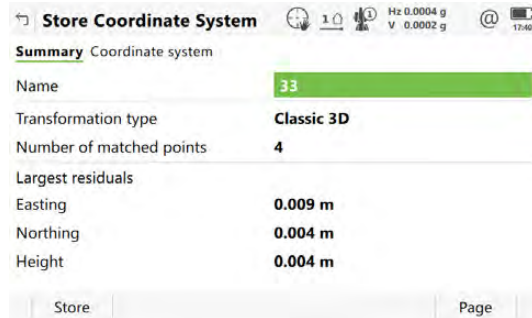

Key	Description
Store	To store the coordinate system to the DBX and return to Leica Captivate - Home .
Page	To change to another page on this panel.

Description of fields

Field	Option	Description
Name	Editable field	The name of the coordinate system can be changed. The name can be up to 16 characters in length and include spaces.
Transformation type	Display only	The type of transformation used.
Number of matched points	Display only	Number of matched points.
Easting	Display only	Largest Easting residual from the transformation calculation.
Northing	Display only	Largest Northing residual from the transformation calculation.
Height	Display only	Largest Height residual from the transformation calculation.

Next step

Page changes to the **Coordinate system** page.

Store Coordinate System, Coordinate system page

Description of fields

Field	Option	Description
Residuals	None , 1/distance , 1/distance² , 1/distance^{3/2} or Multiquadratic	The method by which the residuals of the control points are distributed throughout the transformation area.
Geoid model	Display only	Name of geoid model used.
Pre-transformation	Display only	For Twostep: Name of the pre-transformation used.
Transformation	Display only	For Classic 3D: Name of transformation used.
Ellipsoid	Display only	For Twostep and Classic 3D: Name of ellipsoid used.
Projection	Display only	For Twostep and Classic 3D: Name of projection used.
CSCS model	Display only	For Classic 3D: Name of CSCS model used.

Next step

Store stores the coordinate system to the DBX and attaches it to the **Job where WGS84 points are stored** selected in **Choose Jobs**, replacing any coordinate system attached to this job. **Job where WGS84 points are stored** becomes the job.

39.3.3

Modifying a Coordinate System

Access

OK in **Determine Coord System** when **Method: Modify existing**.

Coordinate Systems

Select an existing coordinate system and press **OK**.

All the following steps are identical with the determination of a new coordinate system from the **Matched Points (n)** panel onwards. Refer to "39.3.2 Determining a New Coordinate System"

39.3.4

Matching Points: Selecting/ Editing a Pair of Matching Points

Description

Before calculating a transformation, it must be defined which points in **Job where WGS84 points are stored** and **Job where local points are stored** are to be matched. Pairs of matched points are displayed in one line in **Matched Points (n)**. New pairs of matched points can be created, existing pairs of matched points can be edited and pairs of matched points can be deleted.

Access

Press **New** or **Edit** in **Matched Points (n)**.

Choose Matching Points/ Edit Matching Points

Key	Description
OK	To return to Matched Points (n) and to adds a line of matched points to the matched points list.
Meas app	To measure a point and store it in Job where local points are stored . Available when Local point is highlighted.

Description of fields

Field	Option	Description
WGS84 point	Selectable list	A WGS 1984 control point.
Local point	Selectable list	A local control point.
Match in		The type of match to be made between the points selected.
	Position & height, Position only, Height only or None.	Available for Onestep and Twostep .
	Position & height or None	Available for Classic 3D .

39.3.5

Transformation Results for Onestep and Twostep

Access

Press **Result** in **Residuals**.

Transformation Results, Position page

Results of the transformation between the WGS1984 datum and the local datum are shown for each of the transformation parameters. This panel con-

sists of the **Position** page and the **Height** page. The explanations for the softkeys given here are valid for the pages as indicated.

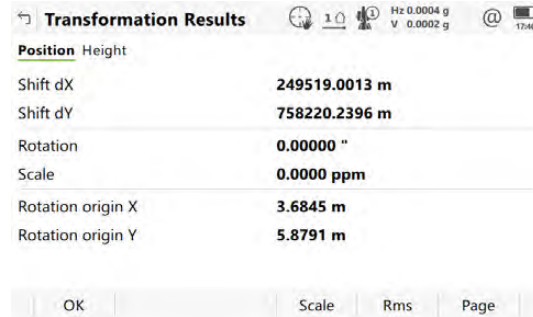

Key	Description
OK	To return to Residuals .
Scale or Ppm	Available on the Position page. To switch between displaying the true scale and displaying the ppm.
Rms or Parameter	To switch between the root mean square values of the parameters and the current parameter values. The name of the panel changes to Results Rms when displaying rms values.
Page	To change to another page on this panel.

Description of fields

Field	Option	Description
Shift dX	Display only	Shift in X direction.
Shift dY	Display only	Shift in Y direction.
Rotation	Display only	Rotation of transformation.
Scale	Display only	Scale factor used in transformation. Either true scale or ppm.
Rotation origin X	Display only	Position in the X direction of the origin of rotation.
Rotation origin Y	Display only	Position in the Y direction of the origin of rotation.

Next step

Page changes to the **Height** page.

Transformation Results, Height page

Description of fields

Field	Option	Description
Slope in X	Display only	Tilt of the transformation in the X direction.
Slope in Y	Display only	Tilt of the transformation in the Y direction.
Height shift	Display only	Shift in height between WGS 1984 datum and local datum.

Next step

OK returns to **Residuals**.

39.3.6

Transformation Results for Classic 3D

Access

Press **Result** in **Residuals**.

Transformation Results, Parameters page

Results of the transformation between the WGS 1984 datum and the local datum are shown for each of the transformation parameters. This panel consists of the **Parameters** page and the **Rotation origin** page. The explanations for the softkeys given here are valid for the pages as indicated.

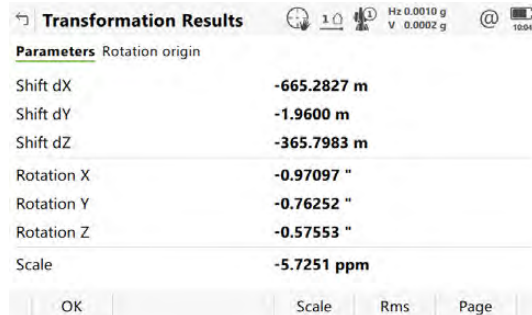

Key	Description
OK	To return to Residuals .
Scale or Ppm	Available on the Parameters page. To switch between displaying the true scale and displaying the ppm.
Rms or Parameter	To switch between the root mean square values of the parameters and the current parameter values. The name of the panel changes to Results Rms when displaying rms values.
Page	To change to another page on this panel.

Description of fields

Field	Option	Description
Shift dX	Display only	Shift in X direction.
Shift dY	Display only	Shift in Y direction.
Shift dZ	Display only	Shift in Z direction.
Rotation X	Display only	Rotation around the X axis.
Rotation Y	Display only	Rotation around the Y axis.
Rotation Z	Display only	Rotation around the Z axis.
Scale	Display only	Scale factor used in transformation. Either true scale or ppm.

Next step

Page changes to the **Rotation origin** page.

Description of fields

Field	Option	Description
Model	Display only	Classic 3D transformation model used for the transformation.
Rotation origin X	Display only	Available for Model: Molodensky-Badekas . Position in the X direction of the origin of rotation.
Rotation origin Y	Display only	Available for Model: Molodensky-Badekas . Position in the Y direction of the origin of rotation.
Rotation origin Z	Display only	Available for Model: Molodensky-Badekas . Position in the Z direction of the origin of rotation.

Next step

OK returns to **Residuals**.

39.4

The One Point Localisation Method

39.4.1

Determining a New Coordinate System

Access

Press **OK** in **Choose Jobs** with **Use one point localisation method** being checked.

Choose Height Mode

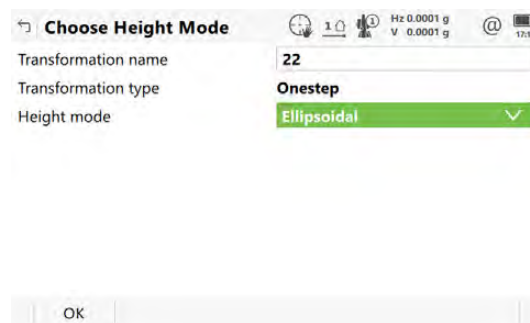

Key	Description
OK	To confirm the selections and to continue with the subsequent panel.

Description of fields

Field	Option	Description
Transformation name	Editable field	A unique name for the transformation. The name can be up to 16 characters in length and include spaces. If a coordinate system is being updated then its name is displayed.
Transformation type	Display only	The type of transformation to be used when determining a coordinate system.
Height mode		The height mode to be used in the determination of a coordinate system.

Field	Option	Description
	Orthometric or Ellipsoidal	Available when determining a new coordinate system.
	Display only	Available when updating a coordinate system. The height mode shown is the same as the mode used in the existing system.

Next step

OK continues to **Coord System Components**.



Azimuth is used throughout this chapter. This term should also always be considered to mean **Bearing**.

Coord System Components

This panel contains different fields, depending on what method was chosen in **Determine Coord System**.

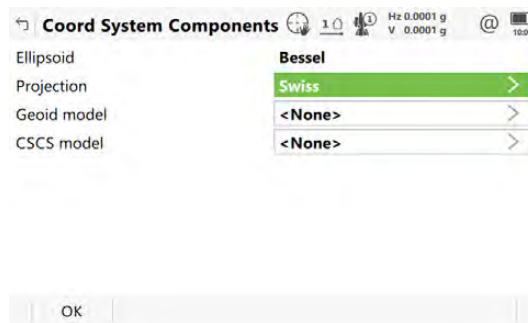

Key	Description
OK	To confirm the selections and to continue with the subsequent panel.

For Onestep

Description of fields

Field	Option	Description
Geoid model	Selectable list	The geoid model to be used in the transformation.
Pre-transformation	Selectable list	For Twostep: The pre-transformation to be used for the preliminary 3D transformation.
Ellipsoid	Selectable list	For Twostep and Classic 3D: The ellipsoid to be used in the transformation.
	Display only	For Twostep: The ellipsoid used by a fixed projection when selected in Projection .
Projection	Selectable list	For Twostep and Classic 3D: The projection to be used in the transformation.
CSCS model	Selectable list	For Classic 3D: The CSCS model to be used in the transformation.

Next step

OK continues to **Choose Common Point**.

Choose Common Point

Choose Common Point

WGS84 point 400

Local point 400

Local height Use WGS84 point height

OK

Key	Description
OK	To confirm the selections and to continue with the subsequent panel.
Meas app	Available for Local point being highlighted. To occupy a point manually and store it in Job where local points are stored .

Description of fields

Field	Option	Description
Match in		For Onestep and Twostep: How the horizontal and vertical shifts of the transformation is computed.
	Position & height	Position and height are taken from the same pair of matching points.
	Position only	Position is taken from one pair of matching points. The height can be taken from another pair of matching points.
WGS84 point	Selectable list	The point ID of the horizontal and/or vertical control point chosen from Job where WGS84 points are stored .
Local point	Selectable list	The point ID of the horizontal and/or vertical control point chosen from Job where local points are stored .
Match height	Check box	For Onestep and Twostep: Available for Match in: Position only . Activates the determination of the vertical shift from a separate pair of matching points.
Local height	Use WGS84 point height or Use Local point height	For Classic 3D: The source of the height information to use in the transformation.

Next step

For Onestep and Twostep: OK continues to **Determine Rotation**.

For Classic 3D: **OK** continues to **Store Coordinate System**.

Determine Rotation

For Onestep and Twostep only.

Key	Description
OK	To confirm the selections and to continue with the subsequent panel.
Inverse	Available for Method: Two WGS84 points and Method: User entered . To compute an azimuth between two local points. Refer to "39.4.2 Computing Required Azimuth".
Meas app	To measure a point and store it in Job where WGS84 points are stored . Available when Point 1 or Point 2 are highlighted for Method: Two WGS84 points or when WGS84 point is highlighted for Method: Convergence angle .

Description of fields

Field	Option	Description
Method	Use WGS84 north, User entered, Convergence angle or Two WGS84 points	Method by which the rotation angle for the transformation is determined.
Rotation	Display only	<ul style="list-style-type: none"> For Method: Use WGS84 north: Transformation is rotated to North as defined by the WGS 1984 datum. North is 0.00000 °. For Method: Convergence angle: The rotation of the transformation calculated as 0.00000 ° minus the computed convergence angle. The field is updated as Coordinate system and WGS84 point are changed.

Field	Option	Description
	Editable field	<ul style="list-style-type: none"> For Method: Two WGS84 points: The rotation of the transformation calculated as required azimuth minus azimuth. The field is updated as Point 1, Point 2 and Required azimuth are changed. For Method: User entered: To manually type in the orientation of the transformation or to calculated in Compute Reqr Azimuth.
Coordinate system	Selectable list	Coordinate system to provide the direction of grid North in the area where the control point used for determining the local coordinate system, is located. Available for Method: Convergence angle .
WGS84 point	Selectable list	WGS 1984 point of which the convergence angle is calculated. Available for Method: Convergence angle .
Point 1	Selectable list	First point to use for computation of Azimuth . Available for Method: Two WGS84 points .
Point 2	Selectable list	Second point to use for computation of Azimuth . Available for Method: Two WGS84 points .
Azimuth	Display only	Computed azimuth between Point 1 and Point 2 . Available for Method: Two WGS84 points .
Required azimuth	Editable field	The required grid azimuth, computed between two local points. Refer to "39.4.2 Computing Required Azimuth". Available for Method: Two WGS84 points .

Diagram for Onestep, Method: Convergence angle

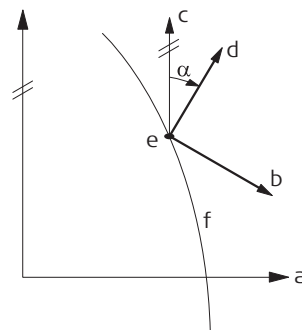

SYS13.008

- a WGS 1984 coordinate system
- b Local coordinate system
- c Geodetic North
- d Grid North
- e Point on WGS 1984 datum
- f Meridian
- α Convergence angle

Diagram for Onestep, Method: Two WGS84 points

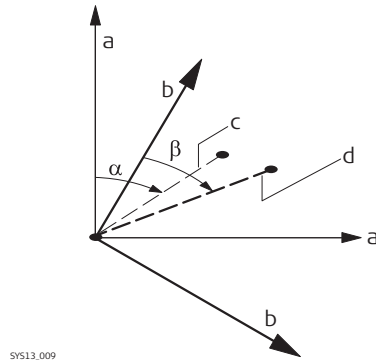

- a WGS 1984 coordinate system
- b Local coordinate system
- c Line between two WGS 1984 points
- d Line between two local points
- α Azimuth of two WGS 1984 points
- β Known azimuth or azimuth of two local points

Next step

OK continues to **Determine Scale**.

Determine Scale

For Onestep and Twostep only.

The scale is calculated using the formula $(r + h)/r$ where

r is the distance from the centre of the ellipsoid to the WGS 1984 point selected in **Choose Common Point**, and

h is the height of this point above the WGS 1984 ellipsoid.

Key	Description
OK	To confirm the selections and to continue with the subsequent panel.
Grid	Available Twostep and for Method: Combined scale factor . To compute the grid scale factor. Refer to "39.4.3 Computing the Grid Scale Factor".
Height	Available Twostep and for Method: Combined scale factor . To compute the height scale factor. Refer to "39.4.4 Computing the Height Scale Factor".
Scale or Ppm	To switch between displaying the true scale and displaying the ppm.
Meas app	To measure a point and store it in Job where WGS84 points are stored. Method: Convergence angle when WGS84 point is highlighted.

Description of fields

Field	Option	Description
Method	Known WGS84 point, Known WGS84 height or User entered	Available for Onestep: Method of determining the scale factor of the transformation.
	User entered or Combined scale factor	Available for Twostep. The default method for determining the Combined Scale Factor to be used in the transformation process.
Scale(Reducing points to the ground)	Editable field	Available for Onestep. Allows the scale factor to be typed in manually. Available for Method: User entered .
	Display only	Available for Onestep. The calculated scale factor. Available for Method: Known WGS84 point and Method: Known WGS84 height .
WGS84 point	Selectable list	Available for Onestep. WGS 1984 point from which the scale factor is calculated. The scale factor is calculated using the height of the known WGS 1984 point. Available for Method: Known WGS84 point .
Known height	Editable field	Available for Onestep. The WGS 1984 height of a point can be typed in. The scale factor is calculated using this height. Available for Method: Known WGS84 height .
Grid scale factor	Display only	Available for Twostep and Method: Combined scale factor . The grid scale factor as computed in Compute Grid Scale Factor . Refer to "39.4.3 Computing the Grid Scale Factor".
Height scale factor	Display only	Available for Twostep and Method: Combined scale factor . The height scale factor as computed in Compute Ht Scale Factor . Refer to "39.4.4 Computing the Height Scale Factor".
Combined scale factor		Available for Twostep. The combined scale factor of the transformation.
	Editable field	Available for Method: User entered . The scale factor can be typed in.
	Display only	Available for Method: Combined scale factor . The product of the grid scale factor and the height scale factor.

Next step

OK continues to **Store Coordinate System**.

Store Coordinate System

Name	33
Transformation type	Classic 3D
Number of matched points	4
Largest residuals	
Easting	0.009 m
Northing	0.004 m
Height	0.004 m

Key	Description
Store	To store the coordinate system to the DBX, attach the system to Job where WGS84 points are stored that was selected in Choose Jobs and return to Leica Captivate - Home .
Scale or Ppm	For Onestep and Twostep. To switch between displaying the true scale and displaying the ppm.
Coord	For Classic 3D: To view other coordinate types.

Description of fields

Field	Option	Description
Name	Editable field	A unique name for the coordinate system. The name can be up to 16 characters in length and include spaces.
Shift dX	Display only	For Onestep, Twostep and Classic 3D: Shift in X direction.
Shift dY	Display only	For Onestep, Twostep and Classic 3D: Shift in Y direction.
Shift dZ	Display only	For Classic 3D: Shift in Z direction.
Rotation	Display only	For Onestep and Twostep: Rotation of transformation.
Scale	Display only	For Onestep and Twostep: Scale factor of transformation.
Rotation origin X	Display only	For Onestep and Twostep: Position in the X direction of the origin of rotation.
Rotation origin Y	Display only	For Onestep and Twostep: Position in the Y direction of the origin of rotation.

Next step

Store stores the coordinate system and returns to **Leica Captivate - Home**.

39.4.2

Computing Required Azimuth

Description

Available for:

- One Point Localisation method with Onestep or Twostep transformation.
- **Method: Two WGS84 points** and **Method: User entered** in **Determine Rotation**.

Allows two local points to be chosen from local job between which the required azimuth is computed. This azimuth is then used with an azimuth computed between two WGS 1984 points chosen from the WGS84 job to calculate the rotation of the transformation.

The computed required azimuth appears in the **Required azimuth** field for **Method: Two WGS84 points** and the **Rotation** field for **Method: User entered** in **Determine Rotation**.

Access

Press **Inverse** in **Determine Rotation**.

Compute Reqrd Azimuth

Compute Reqrd Azimuth

From: 400

To: 400

Azimuth: -----

OK

Key	Description
OK	To calculate the required azimuth and return to the panel from where this panel was accessed.

Description of fields

Field	Option	Description
From	Selectable list	The point ID of the first known point for the azimuth calculation.
To	Selectable list	The point ID of the second known point for the azimuth calculation.
Azimuth	Display only	The calculated azimuth.

Next step

OK returns to **Determine Rotation**.

39.4.3

Computing the Grid Scale Factor

Description

For One Step Localisation method with Twostep transformation. Calculates the grid scale factor. The grid scale factor is the scale factor of the point chosen, relative to the projection being used.

Access

Press **Grid** in **Determine Scale**.

Compute Grid Scale Factor

Compute Grid Scale Factor

Method: Known local point

Local point: 400

Grid scale factor: -----

OK Ppm

Key	Description
OK	To confirm the selections and return to the panel from where this panel was accessed.
Scale or Ppm	To switch between displaying the true scale and displaying the ppm.

Description of fields

Field	Option	Description
Method		Method by which the grid scale factor is calculated.
	User entered	Grid scale factor can be manually typed in.
	Known local point	Grid scale factor is computed using the position of a known local point.
Local point	Selectable list	Available for Method: Known local point . The point ID of the point chosen from the local job from which the grid scale factor is computed using the projection selected.
Grid scale factor		The grid scale factor.
	Editable field	Available for Method: User entered . To type in the grid scale factor.
	Display only	Available for Method: Known local point . The computed grid scale factor.

Next step

OK returns to **Determine Scale**.

39.4.4

Computing the Height Scale Factor

Description

For One Point Localisation method with Twostep transformation. Calculates the height scale factor of the point chosen.

Access

Press **Height** in **Determine Scale**.

Compute Ht Scale Factor

Compute Ht Scale Factor

Method: Known local point

Local point: 400

Height scale factor: 0.999933190

(Reducing points to the ground)

OK Ppm

Key	Description
OK	To confirm the selections and return to the panel from where this panel was accessed.
Scale or Ppm	To switch between displaying the true scale and displaying the ppm.

Description of fields

Field	Option	Description
Method		Method by which the height scale factor is calculated.
	User entered	Height scale factor can be manually typed in.
	Known local point	Height scale factor is computed using the position of a known local point.
	Known local height	Height scale factor is computed using an entered height value.
Local point	Selectable list	Available for Method: Known local point . The point ID of the point chosen from the local job from which the height scale factor is computed.
Known height	Editable field	Available for Method: Known local height . A known local height.
Height scale factor		The height scale factor.
	Editable field	Available for Method: User entered . To type in the height scale factor.
	Display only	Available for Method: Known local point and Method: Known local height . The computed height scale factor.

Next step

OK returns to **Determine Scale**.



For an overview of determine coordinate systems, refer to "39.1 Overview"

Description

QuickGrid is designed to allow for quick coordinate system determination on site. Particularly for those users who must combine GS and TS data. All points must be measured by GS. QuickGrid is not available in TS mode. There are several methods to choose from.

Access

Select **QuickGrid** from the **Leica Captivate - Home** menu.

Choose QuickGrid Method

Description of fields

Field	Option	Description
Method	Single point	This method is fast and targeted at the basic customer who wants to set up a local coordinate system based on a single point. The orientation is fixed to WGS 1984 north. A height scale is applied to bring GS distances to "ground" using measured point WGS 1984 height.
	Multiple points	This method is fast and targeted at the more rigorous customer who wants to set up a local coordinate system based on multiple points. Rotation and scale are as calculated.
	Single point base	This method is fast and targeted at the basic customer who wants to set up a local coordinate system based on the base station position. The orientation is fixed to WGS 1984 north. A height scale is applied to bring GS distances to "ground" using measured point WGS 1984 height.
	Orientate to line	This method is fast and targeted at the more advanced customer who wants to set up a local coordinate system based on a single point, but set the orientation of the resulting grid by measuring a second point. The rotation is as calculated. A height scale is applied to bring GS distances to "ground" using measured point WGS 1984 height.
	QuickShift	This method is fast and targeted at the more advanced customer who wants to shift their existing coordinate system based on a single point. A 3D transformation is calculated.

Next step

IF the selected method is	THEN
Single point, Multiple points, Single point base or Orientate to line	OK to access Define Local Quickgrid Pt.
QuickShift	OK to access Choose Coordinate System.

Choose Coordinate System

This panel is only available for **Method: QuickShift.**

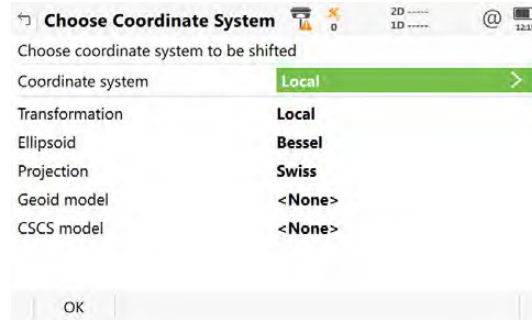

Key	Description
OK	To confirm the selections and to continue with the subsequent panel.

Description of fields

Field	Option	Description
Coordinate system	Selectable list	Select the coordinate system to be shifted.
Transformation	Display only	The type of transformation.
Ellipsoid	Display only	The coordinates are based on this ellipsoid.
Projection	Display only	The map projection.
Geoid model	Display only	The geoid model.
CSCS model	Display only	The Country Specific Coordinate System model.

Next step

OK accesses **Define Local Quickgrid Pt.**

Define Local Quick-grid Pt

Define Local Quickgrid Pt

Local point: From design job

Point ID: 400

Easting: 762455.0520 m

Northing: 242995.4060 m

Height: 424.7250 m

Ignore local height & use WGS84 height:

Use geoid:

OK

Key	Description
OK	To confirm the selections and to continue with the subsequent panel.

Description of fields

Field	Option	Description
Local point	User entered	The local point is entered manually.
	From working job	The local point is selected from the job.
	From design job	The local point is selected from the design job.
Point ID	Editable field	The point ID of the local point. For Local point: User entered .
	Selectable list	For Local point: From working job and Local point: From design job .
Easting	Editable field	The Easting coordinate of the local point. For Local point: User entered .
	Display only	For Local point: From working job and Local point: From design job .
Northing	Editable field	The Northing coordinate of the local point. For Local point: User entered .
	Display only	For Local point: From working job and Local point: From design job .
Height	Editable field	The orthometric height of the local point. For Local point: User entered .
	Display only	For Local point: From working job and Local point: From design job .
Ignore local height & use WGS84 height	Check box	When this box is checked, no height adjustment is calculated. When this box is not checked, a height adjustment is calculated.
Use geoid	Check box	Check this box to select a geoid model for the calculation.
Geoid model	Selectable list	Available when Use geoid is checked. To select a geoid model.

Next step

OK accesses **Measure QuickGrid Point**.

40.2

Determining a New Coordinate System

Access

Press **OK** in **Define Local Quickgrid Pt.**

Measure QuickGrid Point

This panel is similar to the standard Measure panel. Refer to "54.1.2 Real-Time Rover Operations".

Next step

- For **Method: Multiple points**: After measuring and storing a point, **Matched Pts & Residuals** is accessed.
- For **Method: Orientate to line**: Measure the points of the line. Then **Store Coordinate System** is accessed.
- For all other methods: After measuring and storing a point, **Store Coordinate System** is accessed.

Matched Pts & Residuals

This panel shows what points have been matched so far. More points can be added, matched points can be deleted.

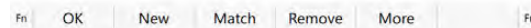

Key	Description
OK	To confirm the selections, compute the transformation and continue with the subsequent panel.
New	To survey another point and return to the Measure panel.
Match	To change the type of match for the highlighted point.
Remove	To delete the highlighted point from the list.
More	To display information about height residuals.

Description of metadata

Metadata	Description
-	The point ID of the points chosen from the job.
Match	The type of match to be made between the point and the surveyed point. This information is used in the transformation calculation. Position and height, position only, height only or none.

Metadata	Description
East, North and Height	The residuals of the matched points.

Next step

Press **New** to survey another point for the calculation.

Press **OK** to continue with **Store Coordinate System**.

Store Coordinate System, Summary page

The available fields, keys and pages depend on the selected method.

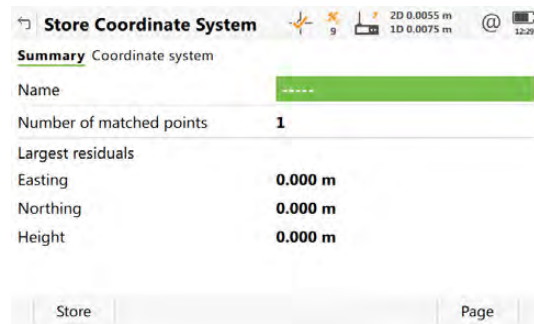

Key	Description
Store	To store the coordinate system and to exit the Determine Coordinate System app.
Page	To change to another page on this panel.

Description of fields

Field	Option	Description
Name	Editable field	The name of the new coordinate system.
Number of matched points	Display only	Available for Multiple points . The number of matched points.
Largest residuals Easting, Northing and Height	Display only	Available for Multiple points . The largest residuals of the transformation.
Rotation from north	Display only	Available for Orientate to line . The rotation is shown in the configured angle units.
Shift dX	Display only	Available for QuickShift . Shift in X direction.
Shift dY	Display only	Available for QuickShift . Shift in Y direction.
Shift dZ	Display only	Available for QuickShift . Shift in Z direction.

Next step

Page changes to the **Coordinate system** page.

Store Coordinate System, Coordinate system page

The available fields, keys and pages depend on the selected method.

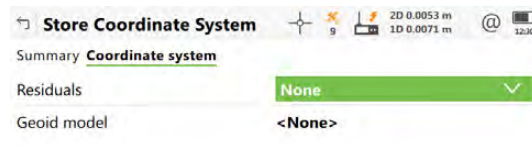

Key	Description
Store	To store the coordinate system and to exit the Determine Coordinate System app.
Page	To change to another page on this panel.

Description of fields

Field	Option	Description
Residuals		For Multiple points . The method by which the residuals of the control points are distributed throughout the transformation area.
	None	No distribution is made. Residuals remain with their associated points.
	1/distance, 1/distance² or 1/distance^{3/2}	Distributes the residuals according to the distance between each control point and the newly transformed point.
	Multiquadratic	Distributes the residuals using a multiquadratic interpolation approach.
Transformation	Display only	Available for QuickShift . The type of transformation.
Ellipsoid	Display only	Available for QuickShift . The coordinates are based on this ellipsoid.
Projection	Display only	Available for QuickShift . The map projection.
Geoid model	Display only	Available for Multiple points and QuickShift . The geoid model used.
CSCS model	Display only	Available for QuickShift . The Country Specific Coordinate System model.

Next step

Store saves the new coordinate system.

41

Measure to line/Stake to line

41.1

Overview

Description

The Measure to line/Stake to line app can be used to stake out or measure points relative to a line.

Tasks

The Measure to line/Stake to line app can be used for the following tasks:

- Measuring to a line where the coordinates of a design point can be calculated from its position relative to the defined line.
- Staking to a line where the position of a design point is known and instructions to locate the point are given relative to the line.
- Gridstaking a line where a grid can be staked relative to a line.
- Viewing the position relative to a slope defined from the line.

Other functionality available includes:

- Shifting the line with parallel offsets.
- Referencing to a specific segment of a line.
- Reversing the direction of a line.

Activating the app

If the message panel appears which requires that the app must be activated using a licence key then refer to "29.3 Load licence keys".

Point types

Lines/arcs can be created from points stored as:

- WGS 1984 geodetic
- Local grid

A local grid must always be available when using the app.

Linked jobs and global data

Linked jobs will overwrite the points and lines from the global design job selected in **Design Data**.



Terms

Term	Description
Reference point	Used in this chapter to refer to the location on the line that is perpendicular to the measured position.
Design point	The design point. <ul style="list-style-type: none"> • For measuring to a line, this term refers to the point with the coordinates of the current position and the designed or calculated height. • For staking or grid staking to a line, this term refers to the point to be staked, defined by the user
Measured point	The current position.
Line	 <p>A line can be a straight line between two points, an arc or a multi-point line made up of multiple individual line sections. It may be constructed by joining many "point to points", by creating the sections segment-by-segment, or by creating an alignment.</p>

Term	Description
Line segment	 <p>A line segment is an individual component of a multi-line such as a polyline or an alignment. The segment can be a straight or an arc.</p>

Preparing the data

Create line data by one of the following methods:

Method	Description
Create lines onboard	
	The Measure to line/Stake to line app supports DBX polylines. DBX areas can be also used as closed polylines.
Data management	Refer to "7 Job Menu - View & edit data".
Create Control Data	Lines can be created using the Create line function. Refer to "Create new line/arc".
3D viewer	From 3D viewer, lines can be created, imported or selected to be used in Measure to line/Stake to line. Refer to "35.6 Context Menu".
Survey linework	Lines can be created by measuring points in the field. Lines can be made using the line-work commands.
Road data in Alignment Editor	Using the Alignment Editor app, a simple centreline alignment can be created and be imported.  Only straight and curve elements are supported. The alignment created with the Alignment Editor app must be converted to a Roads Job.
Import lines	
Import an individual line from DXF background map	Using a DXF file attached as a background map, lines can be selected and imported within 3D viewer, Measure or Measure to line/Stake to line apps.
Import all objects including lines from DXF	Copy the DXF files to the \DATA directory on the data storage device of the instrument. Once the card is back in the instrument the DXF import program can be used to bring the lines into the job.
Import from XML	Copy the DXF files to the \DATA directory on the data storage device of the instrument. Once the card is back in the instrument the XML import program can be used to bring the lines into the job.
Import Road alignments	Alignment in Import data supports various different formats like dxf, LandXml, MxGenio, Terramodel, Carlson.
Create lines externally	

Method	Description
Infinity	Refer to Infinity Online Help.
Design to Field	Using the Design to Field tool of Infinity, you are able to bring in lines from multitudes of formats. For example, XML, DXF, Microstation XML and many more. Refer to Infinity Online Help for information on Design to Field.
Some 3 rd party software export to Leica database	-



Refer to "B Directory Structure of the Memory Device" for the placements of the data files on the data storage device.

Defining chainage

The chainage of the start point of a line can be defined.

Coordinate systems

Lines and points defining the lines can be read from the design job using the active coordinate system. For this reason, the coordinate system in the design job must match the active one in the job.

If using TS, select the **<None>** or a local grid coordinate system.

If using GS, a local grid coordinate system must be used. Working in WGS84 coordinates is not supported. Measured WGS84 coordinates are converted to grid using the active coordinate system.

It is possible to use a valid coordinate system, but have the line or part of it lying outside the projection or CSCS model being used.

In these cases, the field values relating to the difference in coordinates between the design point and current position are shown as -----.



Azimuth is used throughout this chapter. This term should also always be considered to mean **Bearing**.

Direction of values

The following diagram shows the direction of positive and negative values for distance and height differences between the design point and the measured point.

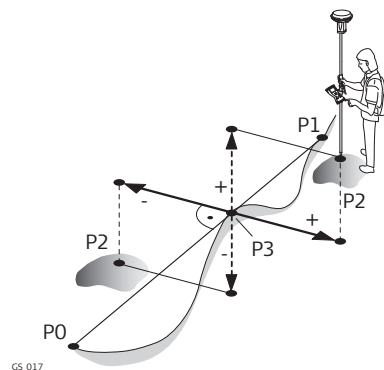

For GS:

- P0 Start point
- P1 End point
- P2 Measured point
- P3 Reference point

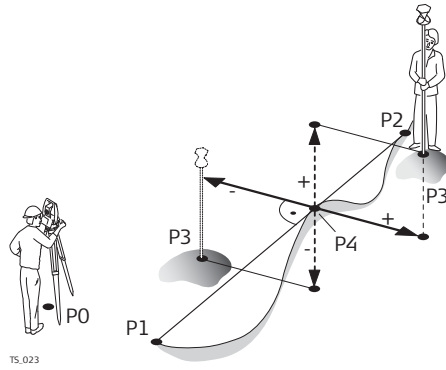

For TS:

- P0 Instrument setup
- P1 Start point
- P2 End point
- P3 Measured point
- P4 Reference point

Shifts

A line can be shifted. A shift is permanently applied to the line during of the Measure to line/Stake to line task.

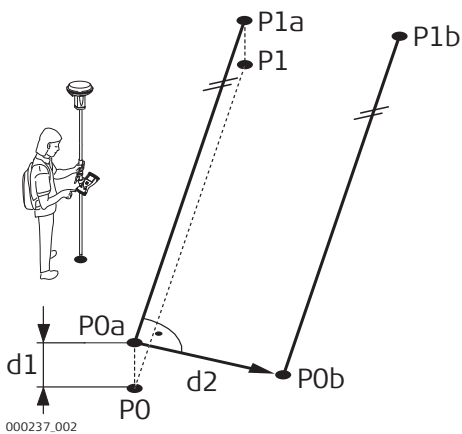

For GS:

- P0 Start point
- P1 End point
- P0a Start point with **Vertical** shift
- P1a End point with **Vertical** shift
- P0b Start point with **Horizontal** shift
- P1b End point with **Horizontal** shift
- d1 **Vertical** shift
- d2 **Horizontal**

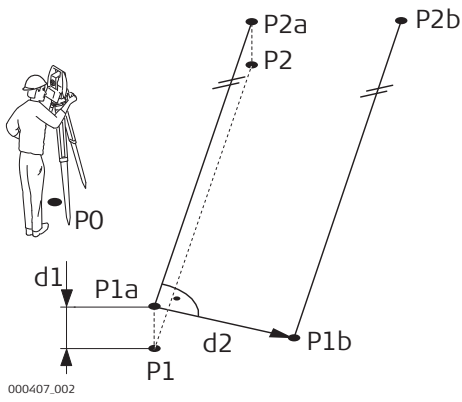

For TS:

- P0 Instrument setup
- P1 Start point
- P2 End point
- P1a Start point with **Vertical** shift
- P2a End point with **Vertical** shift
- P1b Start point with **Horizontal** shift
- P2b End point with **Horizontal** shift
- d1 **Vertical**
- d2 **Horizontal**

41.2

Accessing Measure to line/Stake to line

Access

- For measuring tasks:
Select **Leica Captivate - Home: Measure to line.**
- For staking tasks:
Select **Leica Captivate - Home: Stake to line.**



The lines are stored in the selected design job.
The measurements are stored to the selected job.

The coordinate systems in the design job and in the job must match, otherwise a warning message appears to prevent any further step.

Task

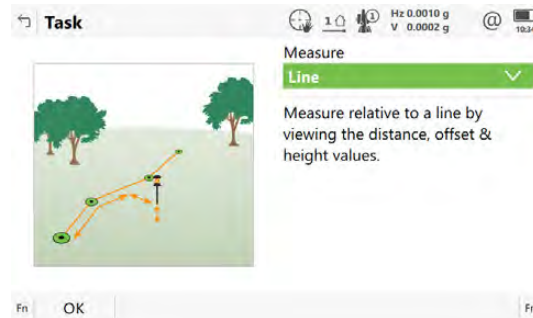

Key	Description
OK	To select the highlighted option and to continue with the subsequent panel.
Fn Settings	To configure the Measure to line/Stake to line app.

Description of the Measure to line/Stake to line tasks

For Measure to line

Task	Description
Line	Measure relative to a line by viewing the distance, offset & height values.
Line with slope	Measure relative to a line by viewing the distance, offset & height values. Additionally view position relative to a defined slope from the line.
Segment	Measure relative to a line segment by viewing the distance, offset & height values. A segment may be an individual straight or arc, or a segment within a line.
Segment with slope	Measure relative to a line segment by viewing the distance, offset & height values. Additionally view position relative to a defined slope from the line.
Quick Line	Create a temporary line from 2 points & measure relative to it by viewing the distance, offset & height values.

For Stake to line

Task	Description
Line	Stakeout relative to a line by defining the distance, offset & height.
Line with slope	Stakeout relative to a line by defining the distance, offset & height. Additionally view position relative to a defined slope from the line.
Grid	Define & stakeout a grid of points relative to a line.

Task	Description
Segment	Stakeout relative to a line segment, by defining the distance, offset & height. A segment may be an individual straight or arc, or a segment within a line.
Segment with slope	Stakeout relative to a line segment, by defining the distance, offset & height. Additionally view position relative to a defined slope from the line.
Quick Line	Create a temporary line from 2 points & stakeout relative to it by defining the distance, offset & height.

Next step

OK accesses **Define Line**.

41.3

Configuring Measure to line/Stake to line

Access

Press **Fn Settings** in the input panels of the Measure to line/Stake to line app.

Settings, General page

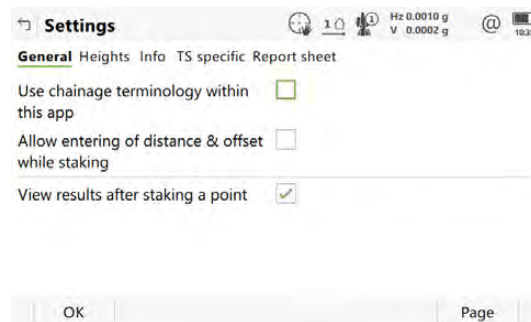

Key	Description
OK	To accept changes and return to the panel from where this panel was accessed.
Page	To change to another page on this panel.
Fn About	To display information about the app name, the version number, the date of the version, the copyright and the article number.

Description of fields

Field	Option	Description
Use chainage terminology within this app	Check box	Activates the use of chainages within the Measure to line/Stake to line app. If the box is not checked, Distance along line is used for data input purposes.
Allow entering of distance & offset while staking	Check box	When this box is checked, stake values can be defined while staking out.

Field	Option	Description
View results after staking a point	Check box	When this box is checked, the stake results are displayed after staking a point.

Next step

Page changes to the **Graphics** page.

Settings, Graphics page

This page is only available for staking operations.

Description of fields

Field	Option	Description
Help me navigate		The reference direction to be used to stake-out points. The stakeout elements and the graphical display shown in the Measure to line/Stake to line app are based on this selection.
	Using line being staked	The direction of the orientation is parallel to the line.
	From behind instrument	Available for TS. The direction of the orientation is from the instrument to the point to be staked.
	Facing instrument	Available for TS. The direction of the orientation is from the current position relative to the instrument.
	Facing last measured point	The direction of the orientation is from the current position relative to the last recorded point.
	Facing point (design data)	The direction of the orientation is from the current position relative to a point from the design job.
	Facing point	The direction of the orientation is from the current position relative to a point from the job.
	Facing north	Available for GS. The direction of the orientation is from the current position relative to North.
	Following arrow	The direction of the orientation is from the current moving direction to the point to be staked. The graphical display shows an arrow pointing in the direction of the point to be staked. The current position must have moved at least 0.5 m for the orientation to be calculated.
	Facing sun	Available for GS. The position of the sun calculated from the current position, the time and the date.

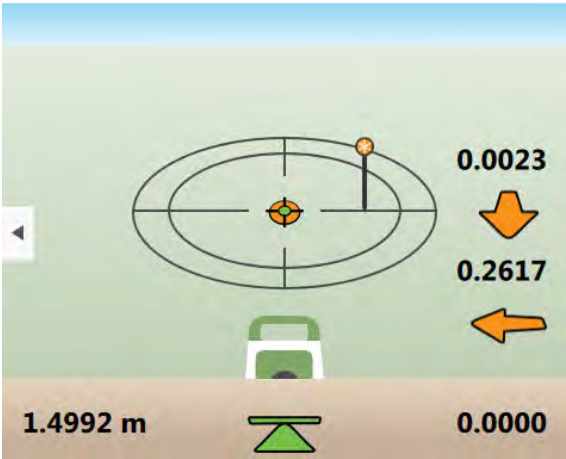
Field	Option	Description
Point ID	Selectable list	Available for Help me navigate: Facing point (design data) and Help me navigate: Facing point . To select the point to be used for orientation.
Navigational arrow types		The method of staking out.
	Direction & distance	The direction from the orientation reference, the horizontal distance and the cut/fill are displayed.
	In/out, left/right	The distance forwards/backwards to the point, the distance right/left to the point and the cut/fill is displayed.
Switch to bulls-eye when 0.5m (1.5ft) from point	Check box	When this box is checked, a bulls eye bubble is shown in any view when less than half metre from the point being staked.
		
Beep faster when getting close to point	Check box	The instrument beeps when the horizontal radial distance from the current position to the point to be staked, is equal to or less than defined in Start within .
Distance to use	Height	The distance in height is used as beep threshold.
	Horizontal distance	The distance from Easting and Northing is used as beep threshold.
	Position & height	The distance from Easting, Northing and Height are used as beep threshold.
Start within	Editable field	The horizontal radial distance from the current position to the point to be staked when a beep is heard.

Next step

Page changes to the **Quality control** page.

Description

Especially when checking points it is useful to enable the **Quality control** criteria available. For every point stored, the chosen parameters are checked. When **Quality control** criteria is fulfilled, the difference icons are turning green, and the measured point can be directly stored. If the check limits are exceeded a warning is shown. This function guarantees a higher productivity as it is no longer necessary to check the values for every shot taken.

Description of fields

Field	Option	Description
Check differences before storing	Check box	When this box is checked, a position check is done when storing a staked point. When the defined tolerance is exceeded, the stakeout can be repeated, skipped or stored. When this box is not checked, no quality check is done during stakeout of points.
Differences to check		 Depending on this selection the following lines are enabled/disabled. <ul style="list-style-type: none"> Chainage, offset & height Check for chainage, horizontal offset and height. Chainage & offset Check for chainage and horizontal offset. Position & height Check for 2D position and height. Position Check for 2D position. Height Check for height.
Chainage limit	From 0.001 to 100	Maximum difference in chainage.
Offset limit	From 0.001 to 100	Maximum horizontal offset from defined position.
Position limit	From 0.001 to 100	Maximum radial horizontal distance.
Height limit	From 0.001 to 100	Maximum height difference.

Next step

Page changes to the **Heights** page.

Settings,
Heights page

Description of fields

Field	Option	Description
Allow editing the height of the location being staked	Check box	When this box is checked, the design height can be changed manually for Height: From line or Height: Start point of line .

Next step

Page changes to the **Design** page.

Settings,
Design page

On this page, additional design points to be staked are set. Refer to "41.6 Staking to a Line" for a graphic.

Description of fields

Field	Option	Description
Project to segment of stake position	Check box	When staking on offset line based on a polyline, there are situations where no valid offset information can be calculated and displayed. This situation appears at offset bisected points (BP). When this box is checked, a line is defined to orientate to so that stake values can be calculated and displayed.
Segment to use at Angle Points	Back or Forward	Refer to "Points of interest" for a diagram showing angle points. Defines if the segment used as reference for the stakeout values is in backwards or forwards direction.
Horizontal (PC, PT, AP)	Check box	Horizontal type points occur at the junction between two segments in a line.
Mid curve (MCP)	Check box	Occurs in arc segments.
Curve radius (RP)	Check box	Occurs in arc segments.
Offset bisected point (BP)	Check box	Occurs when the junction between two segments in a line is not tangent AND when offsets are active.
Offset in average direction (Avg)	Check box	Occurs when the junction between two segments in a line is not tangent AND when offsets are active.
Vertical (VPI, Low, High, VPC, VPT)	Check box	Vertical type points occur at the junction between two segments in the vertical alignment of the line, or when a high or low element is found. Example: In a curve between two grades

Next step

Page changes to the **Info** page.

Two things can be configured on this page:

1. The required information for the stake or measure method to be displayed on the  page.
2. If and which user-defined page is displayed.

Key	Description
OK	To confirm the changes and continue.
Clear	To clear all parameters from all lines.
Fn About	To display information about the app name, the version number, the date of the version, the copyright and the article number.
Fn Default	To set the default value for all lines.

Description of fields



Field	Option	Description
Show user defined page	Check box	Shows a selectable list for the pages.
Page to show	Selectable list	The user-defined page to be shown.
Method	Display only	The method is based on the selected Measure to line/Stake to line task. The settings in the following lines can only be changed for the current task. The method defines the parameters available to view on the  page of the app. Different combinations of the parameters to view can be stored.
1st line to 16th line	Selectable list	Define which parameters are viewed on each line. Up to 16 lines of parameters can be defined.



Some of the options are explained in graphics in the following chapters.

Always available

Point ID	To enter the point ID.
Antenna height	For GS: To enter the antenna height.
Target height	For TS: To enter the target height.
Code	Editable field for codes.
Attribute 01 and Attribute 02	Editable field for attributes for codes.

Field	Option	Description
	Chainage	Displays the current chainage.
	Distance along line	Displays the horizontal distance from the start point to the reference point along the line.
	Line offset	Displays the horizontal offset perpendicular from the line to the current position.
	Line height difference	Displays the height difference from the defined line to the current position.
	Line name	Displays the name of the line.
	Line type	Displays the line type as straight, arc or poly-line.
	Easting	Displays the Easting coordinate of the current position.
	Northing	Displays the Northing coordinate of the current position.
	Height	Displays the height of the current position.
	3D quality	For GS: Display only field for the current 3D coordinate quality of computed position.
	Cut/fill	Displays the height difference between the design height and the measured height.
	Go forward/backward	Distance to point. For Navigational arrow types: In/out, left/right in 3D viewer equivalent to: 
	Go left/right	Distance to point. For Navigational arrow types: In/out, left/right in 3D viewer equivalent to: 
	Go	Distance to point. For Navigational arrow types: Direction & distance in 3D viewer equivalent to: 

Field	Option	Description
	Turn left/right	Direction to point. For Navigational arrow types: Direction & distance in 3D viewer equivalent to: 
	Unused line	Insert full line space.
	Separator	Insert half line space.
	For measure with/without slope also available	
	Distance to start point	Displays the horizontal distance from the measured point to the start point of the line.
	Distance to end point	Displays the horizontal distance from the measured point to the end point of the line.
	Line distance to end	Displays the horizontal distance from the end point of the line to the base point of the measured point, along the line.
	Distance to 3D chainage point	Displays the slope distance between the reference point and the measured point, perpendicular to the line. Not displayed when shifts are applied.
	Height difference at 3D chainage	Displays the height difference perpendicular from the line to the horizontal base point. Not displayed when shifts are applied.
	3D chainage	Displays the slope distance between the start point and the reference point. Not displayed when shifts are applied.
	For stake with/without slope also available	
	Difference in distance along line	Displays the horizontal distance along the line from the current position to the defined design point.
	Difference in chainage	Displays the difference between the defined chainage and the current chainage.
	Difference in height	Displays the vertical offset between the defined position and the current position.
	Design Chainage	Displays the defined chainage of the point to be staked out.
	Defined line distance	Displays the defined horizontal distance along the line from the start point to the design point.
	Defined offset	Displays the defined horizontal offset perpendicular from the line to design point.
	Direction to point	Displays the direction from the current position to the design point.
	Distance to point	Displays the distance from the current position to the design point.

Field	Option	Description
Design easting		Displays the Easting of the design point.
Design North		Displays the Northing of the design point.
Design height		Displays the height of the design point, depending on the defined heights to use.
For slope only also available		
Current slope ratio		Displays the ratio of the slope from the current position to the hinge.
Slope design ratio		Displays the defined ratio of the slope from the design point to the hinge.
Slope distance to hinge		Displays the slope distance offset from the hinge to measured point.
Slope distance to line		Displays the slope distance offset from line to measured point.
Height difference to slope		Displays the height difference between the current position and the height of the slope at that position. A cut is above the slope. A fill is below the slope.
Hinge offset		Displays the horizontal offset from the hinge point of the slope to the current position.
Hinge height diff		Displays the height difference from the hinge point of the slope to the current position.

Next step

Page changes to the **TS specific** page.

Settings,
TS specific page

Description of fields

Field	Option	Description
Do not update stakeout values between distance measurements	Check box	When this box is checked, angles and stakeout values are updated after a distance was measured. Then all values are frozen until the next distance is taken.
Automatically aim instrument to point being staked	Check box	When this box is checked, the instrument positions automatically to the point to be staked.
Automatic behaviour		Available when Automatically aim instrument to point being staked is checked.

Field	Option	Description
	Position only	Instrument positions horizontally to the point to be staked.
	Position & height	Instrument positions horizontally and vertically to the point to be staked.
Use two face measurements	Check box	To take a measurement in Face I and Face II. The point stored is an average of the two measurements. When an instrument has auto aiming, the point is automatically measured in both faces. The resulting point is stored and the instrument is returned to the first face.

Next step

Page changes to the **Report sheet** page. Refer to "36 Apps - General".

41.4

Defining the Line

41.4.1

Overview

Description

The definition of the line to be used can require up to three steps, depending on the selected task:

Task	Define Line	Define Segment	Define Slope
Line Quick Line	✓	-	-
Segment Grid	✓	✓	-
Line with slope	✓	-	✓
Segment with slope	✓	✓	✓

41.4.2

Defining the Line

Access

1. Select **Leica Captivate - Home: Measure to line** or **Stake to line**.
2. In **Task**, select the required task and press **OK**.

Define Line, Line page

Key	Description
OK	To accept changes and continue with the subsequent panel.

Key	Description
Create	To create a line. Refer to "12 Creating Points and Lines".
Shifts	To apply horizontal and vertical shifts to the selected line. Refer to "Define Shifts". Available for lines only. If using line segments, shifts are applied in the Define Segment panel.
Page	To change to another page on this panel.
Fn Settings	To configure the Measure to line/Stake to line app.
Fn Report	To view an alignment report. Refer to "Save Line Report,Points page".

Description of fields

Field	Option	Description
Line	Selectable list	To select a line. Open the selectable list to access the Line Selection panel showing all selectable lines from the design job.
Type	Display only	The selected line type as straight, arc or polyline.
Length	Display only	The horizontal grid distance between the two points of the line.
Start chainage	Display only	The beginning chainage of the line.
Height	Selectable list	Depending on the task chosen this parameter determines the design height. <ul style="list-style-type: none"> When measuring to a line, it affects the height difference value. When staking, it affects the delta height value.
	From line	Heights are computed along the line.
	User entered	Heights are typed in manually into the Height field.
	Start point of line	Heights are computed relative to the height of the starting point of the line.
	DTM	The height computed from the DTM at the current position.

Next step

OK accesses **Define Slope, Define Segment, Measure to Line** or **Define Stake**.

Define Line,
3D viewer page

Key	Description
Reverse	To reverse the direction of the lines, so that the distance along line/chainage increment is in the opposite direction to the original: Original: Reverse:

Key	Description

Define Quick Line

When **Quick Line** is the selected task, the line is defined by two points from the design job, instead of an existing line.



When the task is finished or a new quick line is defined, the previously defined quick line is automatically deleted from the database.

Key	Description
OK	To accept changes and continue with the subsequent panel.
Shifts	To apply horizontal and vertical shifts to the defined line. Refer to "Define Shifts".
Meas app	To measure a point. Available when Start point or End point is highlighted.
Fn Settings	To configure the Measure to line/Stake to line app.

Description of fields

Field	Option	Description
Start point	Selectable list	The first point forming the line.
End point	Selectable list	The last point forming the line.
Azimuth	Display only	The direction from the first to the second known point.
Horizontal distance	Display only	The horizontal distance between the two known points.
Height difference	Display only	The height difference between the two known points.
Slope distance	Display only	The slope distance between the two known points.
Grade	Display only	The grade between the two known points.
Height	Selectable list	Depending on the task chosen this parameter determines the design height. <ul style="list-style-type: none"> When measuring to a line, it affects the height difference value. When staking, it affects the delta height value.
	From line	Heights are computed along the line.
	User entered	Heights are typed in manually into the Height field.
	Start point of line	Heights are computed relative to the height of the starting point of the line.

Field	Option	Description
	DTM	The height computed from the DTM at the current position.

Line selection and importing lines

Selecting lines

In **Define Line**, open the selectable list for **Line**.

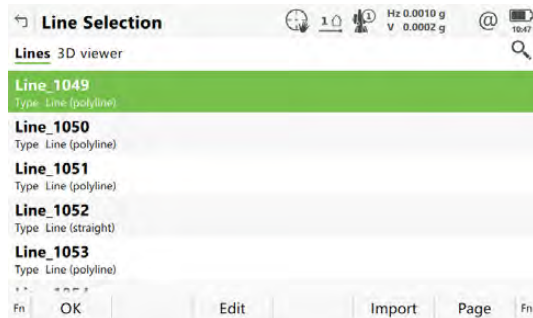

The list contains all selectable lines from the design job. The line ID and the start chainages of lines can be edited.



Key	Description
OK	To select the highlighted line and to return to the panel from where this panel was accessed.
Edit	To edit line ID and the start chainage.
Import	To import a line from a Road/Rail job or from an external job.

Importing lines

Press **Import** to import a single alignment from a Road or Rail job, or a line from another job, to a line to be used in the app. The **Import Line** panel opens.

-  Only alignment geometry that contains lines and simple curves are supported. Clothoids are not supported and cannot be imported.
-  If the source job for the import is the same as the design job, for example when you want to import areas, the imported element is converted to a line with the suffix `_001`.

Key	Description
OK	To import the selected alignment data to active raw alignment.

Description of fields

Field	Option	Description
From		The file type of the data source.
	Job	To import lines from an existing job.
	Road design	To import lines from an existing Road job.
	Rail design	To import lines from an existing Rail job.
	Road+ (GSI format)	To import lines from an existing Road job defined in GSI format.

Field	Option	Description
From job	Selectable list	All jobs are available for selection.
Line	Selectable list	Line from the selected Road job. The line must be stored in the \DBX folder of the data storage device to be selectable.

Save Line Report, Points page

The report displays information on the points that have been measured with the current selected design job, and current select line.

Key	Description
OK	To return to the panel from which this panel was accessed.
Edit	To edit details of the highlighted point.
Save	To save the alignment report.
More	To change the values displayed between Offset, Cut/fill, Measured height, Design ht, Point ID and Pt code .
Page	To change to another page on this panel.

Next step

Page changes to the **3D viewer** page. Use **Ch-** and **Ch+** to the previous or next measured point.

Define Shifts

 **3D viewer** is not updated with shifts.

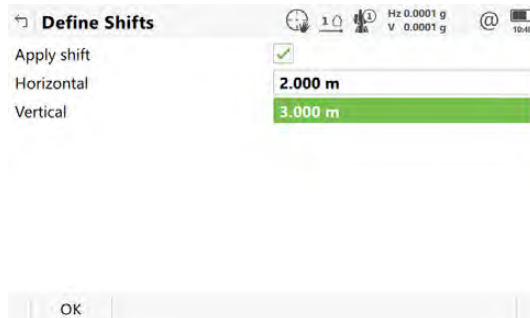

Key	Description
OK	To confirm the selections and to return to the previous panel.

Description of fields

Field	Option	Description
Apply shift	Check box	Check to apply a shift.
Horizontal	Editable field	Distance to shift the line horizontally to the left or right.
Vertical	Editable field	The vertical shift of the line.

Field	Option	Description
Rotate line	Editable field	Available for Measure: Quick Line . To rotate the line by the defined angle value - clockwise if not defined otherwise in Regional .  If values are entered for both Rotate line and Horizontal , the horizontal shift is applied to the rotated line.

41.4.3

Defining a Segment of a Line

Description

Define Segment, Segment page appears when the selected method is **Segment, Segment with slope** or **Grid**. A segment can be a straight or an arc.

Define Segment, Segment page

Key	Description
OK	To accept changes and continue with the subsequent panel.
Shifts	To apply horizontal and vertical shifts to the selected segment. Refer to "Define Shifts".
Segment - or Segment +	To select the previous/next segment in the line.
Page	To change to another page on this panel.
Fn Settings	To configure the Measure to line/Stake to line app.

Description of fields

Field	Option	Description
Line	Display only	The current line.
Segment number	Editable field	The line segment number to work with. A polyline is split into segments, naming from 1 upwards.
Segment type	Display only	The selected line type as straight or arc.
Segment length	Display only	The horizontal grid distance between the two points of the line segment.
Start chainage	Display only	The beginning chainage of the line segment.

41.4.4

Defining Line Slopes

Description

It is possible to define slopes for line. When measuring or staking to the line, additional information about the position relative to the slope is displayed.

Stakeout values still refer to the line. For the  page, additional information relative to the slope can be configured in **Settings, Info** page.

Define Slope

Define Slope

Line: **Line_1049**

Slope direction: **Left down**

Slope: **1:1 hv**

Hinge horizontal offset: **2.000 m**

Hinge vertical offset: **2.000 m**

Fn OK Fn

Key	Description
OK	To accept changes and to continue with the subsequent panel.
Fn Settings	To configure the Measure to line/Stake to line app.

Description of fields

Field	Option	Description
Line	Display only	The current line.
Slope direction	Left down	Creates a downward plane extending to the left of the defined line.
	Right down	Creates a downward plane extending to the right of the defined line.
	Left up	Creates an upward plane extending to the left of the defined line.
	Right up	Creates an upward plane extending to the right of the defined line.
Slope	Editable field	Inclination of the slope.
Hinge horizontal offset	Editable field	Horizontal offset from the line that sets where the slope starts.
Hinge vertical offset	Editable field	Vertical offset from the line that sets where the slope starts.

41.5

Measuring to a Line

Description

The horizontal and vertical position and the distance along line/chainage of a manually measured point can be calculated relative to the defined line. Information can be measured and displayed in the  page, and then exported. Refer to "Settings,Info page".

Measure to line - straight segment - horizontal measurements

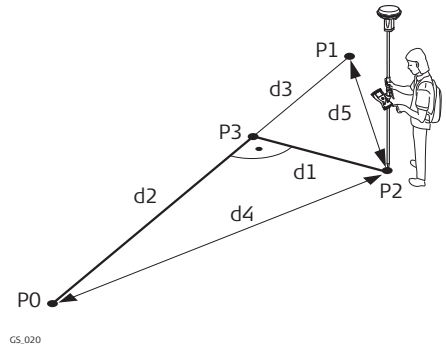

GS.020

For GS:

- P0 Start point
- P1 End point
- P2 Measured point
- P3 Reference point
- d1 **Line offset**
- d2 **Distance along line**
- d3 **Line distance to end**
- d4 **Distance to start point**
- d5 **Distance to end point**

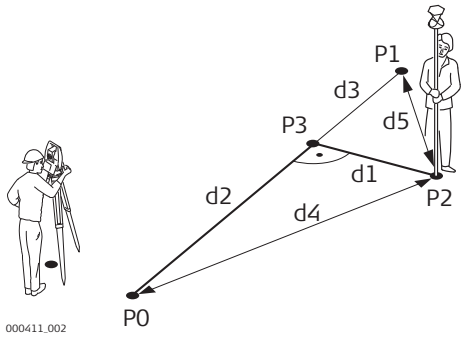

000411.002

For TS:

- P0 Start point
- P1 End point
- P2 Measured point
- P3 Reference point
- d1 **Line offset**
- d2 **Distance along line**
- d3 **Line distance to end**
- d4 **Distance to start point**
- d5 **Distance to end point**

Measure to line - straight segment - vertical measurements

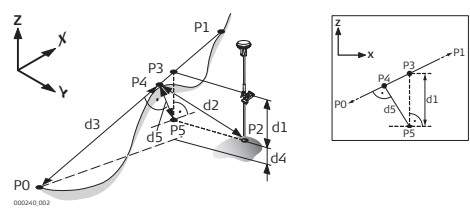

000240.002

For GS:

- P0 Start point
- P1 End point
- P2 Measured point
- P3 Reference point
- P4 Perpendicular point
- P5 Horizontal base point
- d1 **Line height difference**
- d2 **Distance to 3D chainage point**
- d3 **3D chainage**
- d4 **Difference in height**
- d5 **Height difference at 3D chainage**

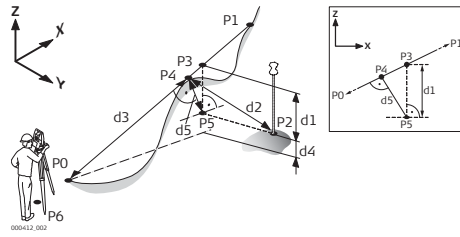

For TS:

- P0 Start point
- P1 End point
- P2 Measured point
- P3 Reference point
- P4 Perpendicular point
- P5 Horizontal base point
- P6 Instrument setup
- d1 **Line height difference**
- d2 **Distance to 3D chainage point**
- d3 **3D chainage**
- d4 **Difference in height**
- d5 **Height difference at 3D chainage**

Measure to line - arc segment - horizontal measurements

Design point inside arc

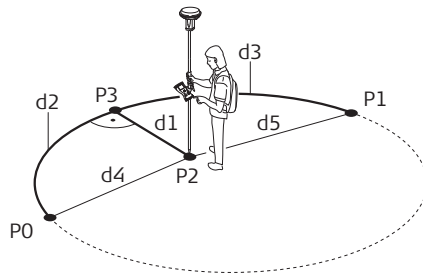

GS_022

For GS:

- P0 Start point
- P1 End point
- P2 Measured point
- P3 Reference point
- d1 **Line offset**
- d2 **Distance along line**
- d3 **Line distance to end**
- d4 **Distance to start point**
- d5 **Distance to end point**

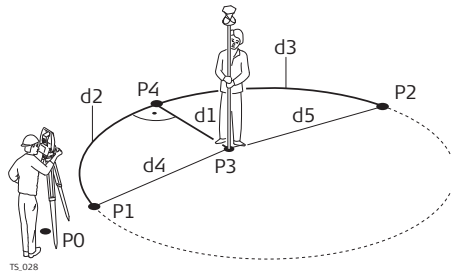

TS_028

For TS:

- P0 Instrument setup
- P1 Start point
- P2 End point
- P3 Measured point
- P4 Reference point
- d1 **Line offset**
- d2 **Distance along line**
- d3 **Line distance to end**
- d4 **Distance to start point**
- d5 **Distance to end point**

Measure to line - arc segment - vertical measurements

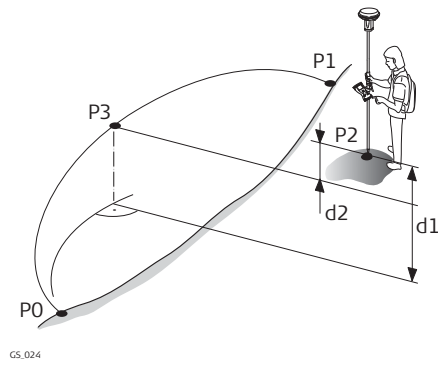

For GS:

- P0 Start point
- P1 End point
- P2 Measured point
- P3 Reference point
- d1 **Difference in height**
- d2 **Line height difference**

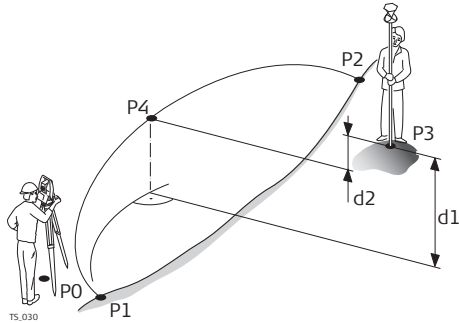

For TS:

- P0 Instrument setup
- P1 Start point
- P2 End point
- P3 Measured point
- P4 Reference point
- d1 **Difference in height**
- d2 **Line height difference**



Design point outside the range of the selected element:

When measuring outside of the defined lines, lines and arcs are extended in a straight projection tangent to the start/end of the line. For **Height: From line**, the start/end grade of the line is also extended. A warning appears when this is the case.

When working with segments, the same extension rules are applicable to the selected segment beyond its limits. For lines imported from a road alignment, heights are not extended outside the segment.

Measure to Line, page

An additional page is available when a user-defined page is used.

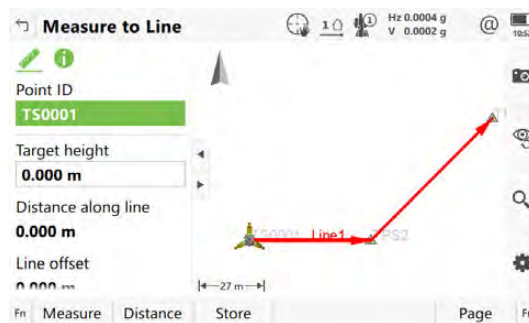

Key	Description
Measure	For GS: To start measuring the point being staked. The key changes to Stop . The difference between the current position and the point being staked is still displayed.
Measure	For TS: To measure a distance and store distance and angles.

Key	Description
Stop	For GS: To end measuring the point being staked. When Automatically stop point measurement is checked in GS Quality Control, General page recording of positions ends automatically as defined by the stop criteria. The key changes to Store .
Store	For GS: To store the measured point. When Automatically store point is checked in GS Quality Control, General page, the measured point is stored automatically. The key changes to Measure . For TS: To store angles and distance. Distance must be measured before.
Distance	For TS: To measure a distance.
Page	To change to another page on this panel.
Fn Settings	To configure the Measure to line/Stake to line app. Refer to "41.3 Configuring Measure to line/Stake to line".
Fn Connect and Fn Disconnect	For GS: To connect/disconnect from the reference data.
Fn Tools	Refer to "37 Apps - The Toolbox".

Description of fields

Field	Option	Description
Point ID	Selectable list	The point ID of the point to be measured.
Antenna height	Editable field	For GS: The antenna height. Changes in the antenna height do not update the antenna height as defined in the active working style. The changed antenna height is used until the app is exited.
Target height	Editable field	For TS: The last used target height is suggested. An individual target height can be typed in.
Chainage	Display only	Chainage of the current position along the line. This value is the chainage of the start of the line plus Distance along line .
Distance along line	Display only	Horizontal distance from the start point to the reference point along the line.
Line offset	Display only	Perpendicular offset from the line measured from the reference point to the measured point.
Height difference	Display only	Difference between measured height and design height.

Next step

Page changes to the user definable  page. Refer to "41.3 Configuring Measure to line/Stake to line" for information on all available items.

Displayed is in 3D viewer

- the horizontal distance or chainage along the line from the start point to the reference point.
- the perpendicular offset from the line measured from the reference point to the measured point.
- the cut/fill value.

41.6

Staking to a Line

Description

Allows for the position of a point to be defined relative to a line and then staked.

Stake to line - horizontal measurements

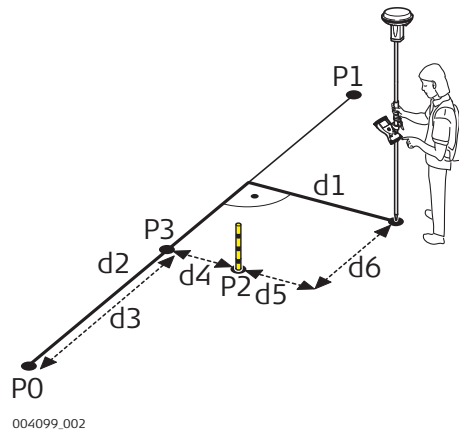

For GS:

- P0 Start point
- P1 End point
- P2 Design point
- P3 Reference point
- d1 **Line offset**
- d2 **Distance along line**
- d3 **Defined line distance**
- d4 **Defined offset**
- d5 **Difference in offset**
- d6 **Difference in distance along line**

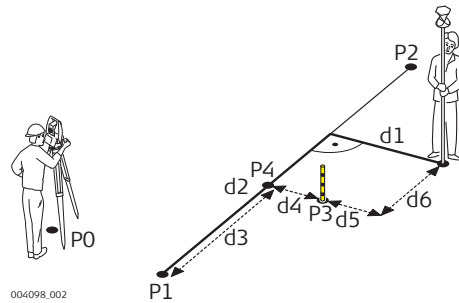

For TS:

- P0 Instrument setup
- P1 Start point
- P2 End point
- P3 Design point
- P4 Reference point
- d1 **Line offset**
- d2 **Distance along line**
- d3 **Defined line distance**
- d4 **Defined offset**
- d5 **Difference in offset**
- d6 **Difference in distance along line**

Stake to line - vertical measurements

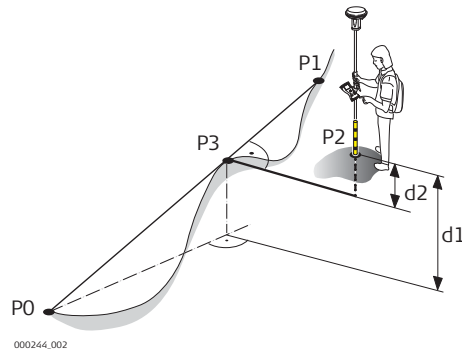

For GS:

- P0 Start point
- P1 End point
- P2 Design point
- P3 Reference point
- d1 **Height offset**, for **Height:Start point of line**
- d2 **Height offset**, for **Height:From line**

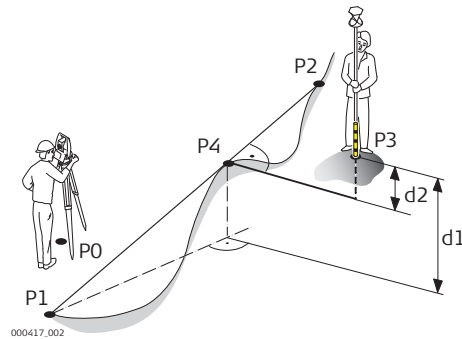

For TS:

- P0 Instrument setup
- P1 Start point
- P2 End point
- P3 Design point
- P4 Reference point
- d1 **Height offset**, for **Height:Start point of line**
- d2 **Height offset**, for **Height:From line**

Define Stake

This panel is for typing in the stakeout values for a point relative to the line. The fields available depend on the options chosen in the **Settings** panel.

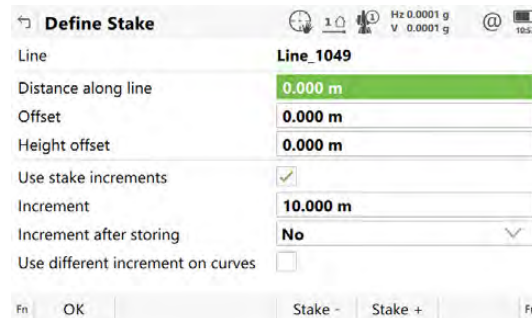

Key	Description
OK	To confirm the selections and to continue with the subsequent panel.
Stake -/Ch-	To decrease the distance along line/the chainage by Increment .
Stake +/Ch+	To increase the distance along line/the chainage by Increment .
Fn Settings	To configure the Measure to line/Stake to line app. Refer to "41.3 Configuring Measure to line/Stake to line".
Fn Report	To view an alignment report. Refer to " Save Line Report,Points page".
Fn Start and Fn End	To change between the start point and the end point of the line.

Description of fields

Field	Option	Description
Line	Display only	The name of the selected line.
Start chainage	Display only	The chainage of the start point of a line.
Chainage	Editable field	Chainage along the line. Define this value as chainage of the start of the line plus a distance along the line.
Distance along line	Editable field	Horizontal distance from the start point along the line to the design point.
Offset	Editable field	The offset from the line to the design point
Height offset	Editable field	The height offset of the design point. <ul style="list-style-type: none"> For Height:Start point of line The height of the design point is calculated as the height of the start point plus Height offset. For Height:From line The height of the design point is calculated as the height of the reference point plus Height offset.
Design height	Editable field	<ul style="list-style-type: none"> For Height:User entered The height of the design point is entered manually.
Use stake increments/Use chainage increments	Check box	Activates the use of stake/chainage increments.
Increment	Editable field	Available when Use stake increments is checked. Stake/chainage increment to be used.
Increment after storing		Sets behaviour of the stake/chainage after a point is stored. <ul style="list-style-type: none"> No Does not change the stake/chainage after a point is stored. Increase Proceeds to the next point up stake/chainage after each stored staked point. Decrease Proceeds to the next point down stake/chainage after each stored staked point.
Use different increment on curves	Check box	Option to use a different chainage increment along a curve.
Increment	Editable field	Available when Use different increment on curves is checked. Chainage increment to be used along the small radius curve.

Field	Option	Description
Only for curves under a radius of	Editable field	Available when Use different increment on curves is checked. Defines the threshold value of a small radius curve. For example, a curve with a radius smaller than this value, uses the chainage increment defined in the following field.

Next step

OK to accept changes and continue to **Stake Points**.

Stake Points, page

Once in the **Stake Points** panels, the user is guided to reach design positions. The functionality of this panel is similar to the **Stake Points** panel. Differences between the two panels are outlined here. Refer to paragraph "51.4 Staking Out" for all other key and field explanations.

In the title bar is a description of where the stake point is on the alignment. This description can come from the position of the defined stake point along the line or a point of intersection. For points of interest, refer to "Points of interest".

The availability of the fields depends on the settings in **Settings, General** page.

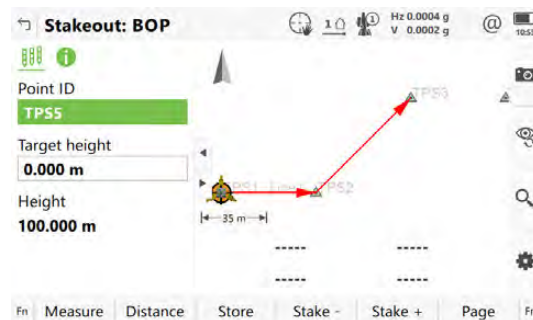

Key	Description
Stake -/Ch-	To decrease the distance along line/the chainage by Increment .
Stake +/Ch+	To increase the distance along line/the chainage by Increment .
Fn Tools	Refer to "37 Apps - The Toolbox".

Description of fields

Field	Option	Description
Point ID	Editable field	The point ID of the point to be staked.
Target height	Editable field	For TS: The last used target height as defined is suggested. An individual target height can be typed in.

Field	Option	Description
Antenna height	Editable field	For GS: The antenna height as defined in the active working style is suggested.
Chainage	Editable field	The current chainage to be staked.
Offset	Editable field	Current offset being staked.
Height	Display only	Measured elevation. The orthometric height of the current position is displayed.
Height	Editable field	Design elevation. The orthometric height of the point to be staked is displayed.

Next step

If configured, the **Results** panel is displayed.

Points of interest

Points of interest are staked out if they appear within the defined **Ch-/Ch+/
Stake -/Stake +** range and if checked in **Settings, Design** page. Refer to "Settings, Design page".

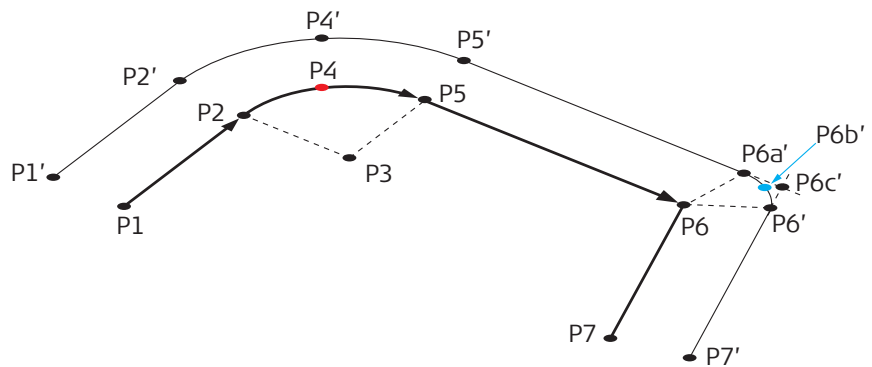

000262_002

On the original line:

P1	BOP - Beginning of project
P2	PC - Beginning of curve
P3	RP - Radius point of the centre of the curve
P4	MCP - Mid point curve
P5	PT - End of curve section - Start of straight segment
P6	AP - Angle point
P7	EOP - End of project

On the offsetted line:

P1'	Offset BOP - Beginning of project
P2'	Offset PC - Beginning of curve
P4'	Offset MCP - Mid point curve
P6'	AP-F - Offset angle point projected to the next segment
P5'	Offset PT - End of curve section - Start of straight segment
P6a'	AP-B - Offset angle point projected to the previous segment
P6b'	AVG - Offset in average direction
P6c'	BP - Offset bisected point
P7'	EOP - End of project

General terms:

- Curve - Along a curve section
- Extension - Along an extended part of the line
- Curve mid point - Mid curve point
- Straight - Along a straight section
- VPI - Vertical interesection point
- Offset PI avg - Offset intersection point average element

Results, General page

If **View results after staking a point** is checked in **Settings, General** page, this panel opens automatically once a point is measured and stored.

BOP, Straight	
General Coords Code 3D viewer	
Point ID	TS0001
Chainage	0.000 m
Offset	0.000 m
Design height	0.000 m
Measured height	1.500 m
Cut	1.500 m
Annotation 1	STA0.00 L0.00 C1.50
Store	Edit Page

Key	Description
OK	To return to the stake panel.
Edit	To add a vertical offset to the design height and to display the new height.
Page	To change to another page on this panel.

Description of fields

Field	Option	Description
Point ID	Editable field	The point ID of the point staked.
Chainage	Display only	The chainage measured at the stored point.
Offset	Display only	The offset from the alignment measured at the stored point.
Design height	Display only	The entered design elevation.
Measured height	Display only	The height measured at the stored point.
Cut/Fill	Display only	The height difference between the Design height and the Measured height .
Annotation 1	Display only	Fixed value recorded for certain software packages.
Annotation 2	Editable field	Available for extra notes.

Next step

Page changes to the **Coords** page. This page displays the design coordinates as well as the differences between design and measured coordinates.

Page changes to the **Code** where codes can be selected or typed in.

3D viewer provides an interactive display of the data.

41.7

Gridstaking to a Line

Description

A grid can be defined relative to a line and points staked out in that defined grid.

Stake grid from line

In same direction

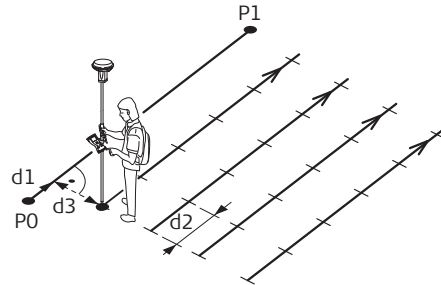

For GS:

- P0 Start point
- P1 End point
- d1 **Distance along line to first grid point**
- d2 Grid spacing along line
- d3 Grid spacing across line

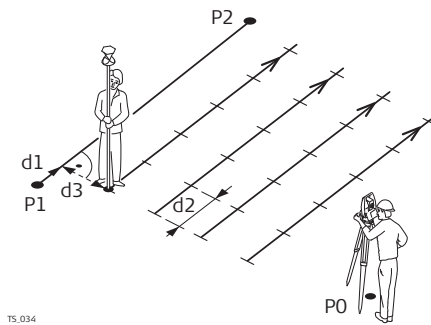

For TS:

- P0 Instrument setup
- P1 Start point
- P2 End point
- d1 **Distance along line to first grid point**
- d2 Grid spacing along line
- d3 Grid spacing across line

In reverse direction

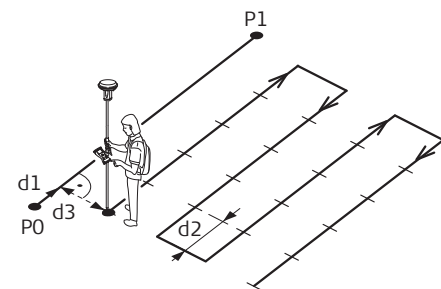

For GS:

- P0 Start point
- P1 End point
- d1 **Distance along line to first grid point**
- d2 Grid spacing along line
- d3 Grid spacing across line

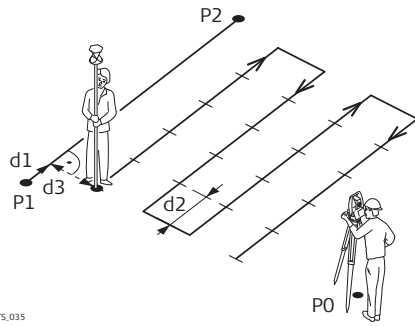

TS_035

For TS:

- P0 Instrument setup
- P1 Start point
- P2 End point
- d1 **Distance along line to first grid point**
- d2 Grid spacing along line
- d3 Grid spacing across line

Define Grid



Key	Description
OK	To confirm the selections and to continue with the subsequent panel.

Description of fields

Field	Option	Description
Distance along line to first grid point	Editable field	Chainage of the first design point to be staked along the line.
Across line	Editable field	Spacing between grid lines.
Along line	Editable field	Spacing between points on the grid line.
Stake next grid line		Method by which the grid is staked out.
	In same direction	Each new grid line is started at the same end as where the previous grid line started.
	In reverse direction	Each new grid line is started at the same end as where the previous grid line finished.
Store point using		Determines the format of the point ID for grid points.
	Grid reference	Point ID is shown as the position of the grid being staked, where +yyy.yy is the chainage position along the grid line, and +xxx.xx is the grid line offset.

Field	Option	Description
	Point ID template	The point ID template as defined in the active working style is used. The point ID template can be defined in Leica Captivate - Home:Settings\ID templates .

Next step

OK to accept changes and continue to the Stakeout panel.

Stake +yyy.yy +xxx.xx

The title of this panel indicates the position of the grid being staked, where +yyy.yy is the chainage position along the grid line, and +xxx.xx is the grid line offset.

The functionality of this panel is similar to the **Stake Points** panel. Differences between the two panels are outlined here. Refer to paragraph "51.4 Staking Out" for all other key and field explanations.

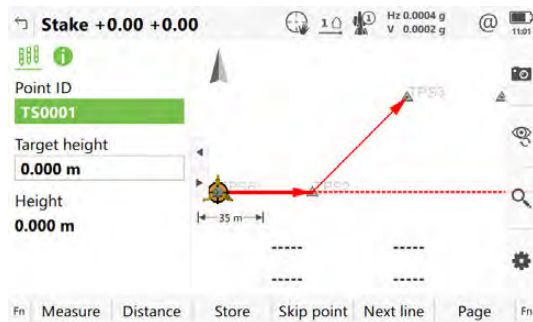

Key	Description
Flip view or Flip view	To reverse the graphical display top to bottom. A reversed graphical display can be used when the point to be staked lies behind the current position.
Skip point	To skip the currently displayed chainage and increment to the next chainage. Available when Measure is displayed.
Next line	To start staking the next grid line. Moves grid stake point to the next line (right) in the grid. There is no automatic Next line when the end of the line is reached.

Description of fields

Field	Option	Description
Point ID	Editable field	The point ID of the grid point to be staked. The point ID is based on the selection for Store point using in Define Grid . If a different point ID is typed in, the next point ID will still be shown as the next automatically computed point ID.
Target height	Editable field	For TS: The last used target height as defined is suggested. An individual target height can be typed in.

Field	Option	Description
Antenna height	Editable field	For GS: The antenna height as defined in the active working style is suggested.
Height	Editable field	Design elevation. The orthometric height of the point to be staked is displayed.

Next step

Displayed is in 3D viewer

- the horizontal distance from the current position to the point to be staked.
- the height difference from the height of the current position to the height of the point to be staked.

42.1

Overview

Description

The Reference Plane & Grid Scan app can be used to measure points relative to a reference plane.

For TS: Any surface can also be grid scanned. It is possible to measure either a regular grid on a predefined reference plane or any surface with an angle-based resolution.

Reference Plane & Grid Scan tasks

The Reference Plane & Grid Scan app can be used for the following tasks:

- Measuring points to calculate and store the perpendicular distance to the plane.
- Viewing and storing the instrument and/or local coordinates of the measured points.
- Viewing and storing the height difference from the measured points to the plane.
- For TS: Grid Scan a defined area on a predefined reference plane with a regular grid or on any surface with an angle-based resolution.



Planes can only be computed with grid coordinates.



For TS: Face scan is available for instruments with reflectorless EDM.

Activating the app

The Reference Plane & Grid Scan app must be activated using a licence key. Refer to "29.3 Load licence keys" for information on how to activate the app.

Defining a reference plane

Reference planes are created using a right-hand system. For two points defining a plane, a vertical plane is used. A reference plane is defined with the X axis and the Z axis of the plane. The Y axis of the plane defines the positive direction of the plane. A reference plane can be defined in the following ways:

- vertical
- tilted
- horizontal

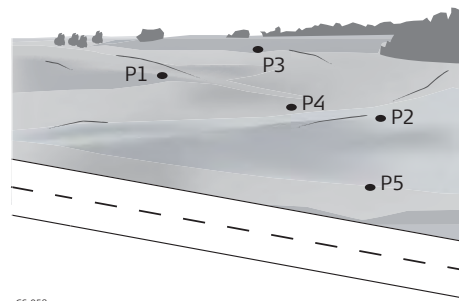

GS.058

For GS:

- P1 Point defining reference plane
- P2 Point defining reference plane
- P3 Point defining reference plane
- P4 Point defining reference plane
- P5 Point defining reference plane

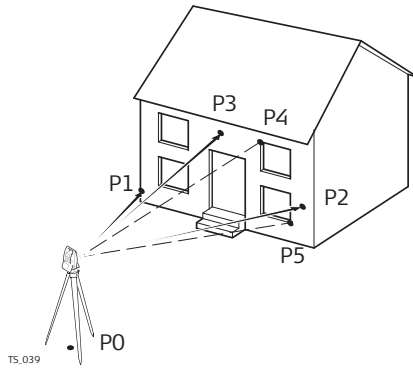

For TS:

- P0 Instrument setup
- P1 Point defining reference plane
- P2 Point defining reference plane
- P3 Point defining reference plane
- P4 Measured point
- P5 Measured point



- For GS: **Measure to plane** is applicable for tilted and horizontal plane definitions.
- For TS: **Measure to plane** and **Grid scan on plane** is applicable for tilted and horizontal plane definitions.

Tilted plane

Any number of points define the plane. The axes of the tilted reference plane are:

Axis	Description
X	Horizontal and parallel to the plane
Z	Defined by steepest direction of the plane
Y	Perpendicular to the plane; increases in the direction as defined
	Offsets are applied in the direction of the Y axis.

For GS:

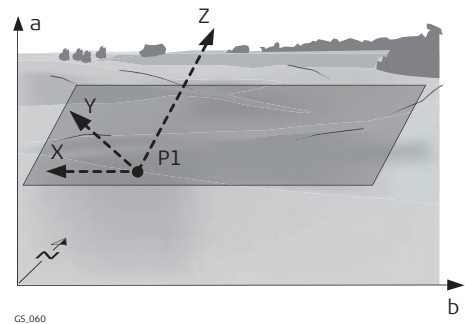
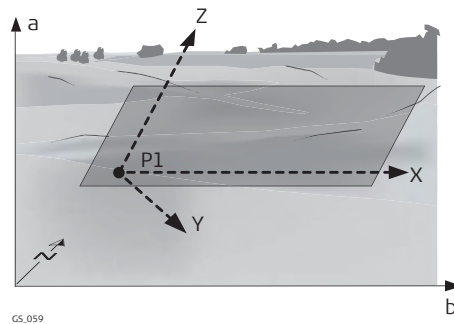

For TS:

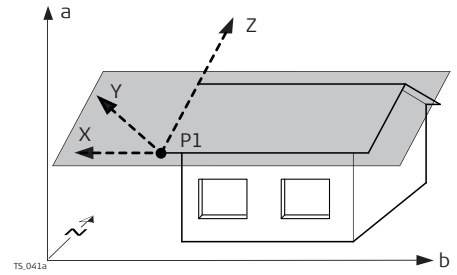
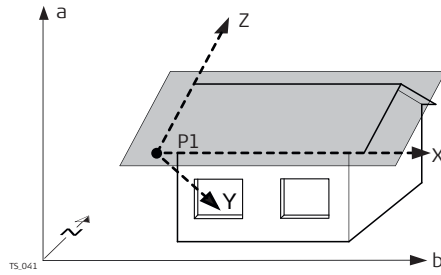

- a Height
- b Easting
- N Northing
- P1 Origin of plane
- X X axis of plane
- Y Y axis of plane
- Z Z axis of plane

Horizontal plane

The axes of the horizontal reference plane are:

Axis	Description
X	Horizontal and parallel to the plane
Z	Perpendicular to the plane; increases in the direction as defined
Y	Parallel to the plane
	Offsets are applied in the direction of the Z axis.

For GS:

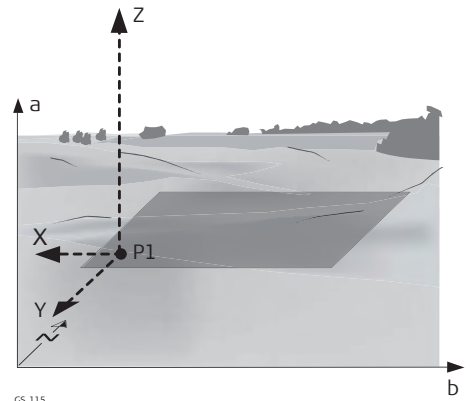
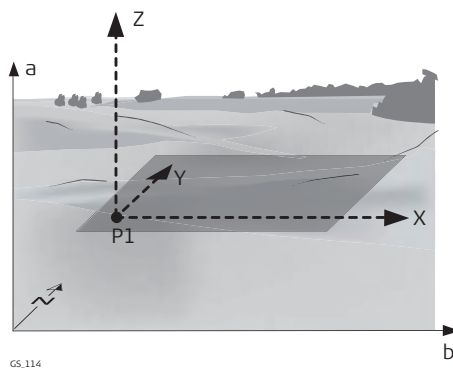

- a Height
- b Easting
- N Northing
- P1 Origin of plane
- X X axis of plane
- Y Y axis of plane
- Z Z axis of plane

For TS:

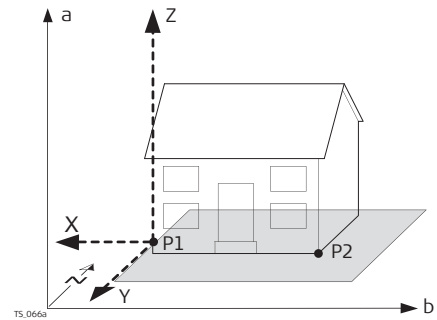
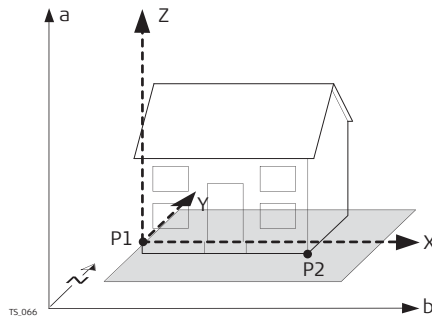

- a Height
- b Easting
- N Northing
- P1 Origin of plane
- P2 Point of plane
- X X axis of plane
- Y Y axis of plane
- Z Z axis of plane

Vertical plane for TS

The axes of the vertical reference plane are:

Axis	Description
X	Horizontal and parallel to the plane; X axis starts in point defined as origin point
Z	Parallel to the instrument zenith and parallel to the plane
Y	Perpendicular to the plane; increases in the direction as defined
	Offsets are applied in the direction of the Y axis.

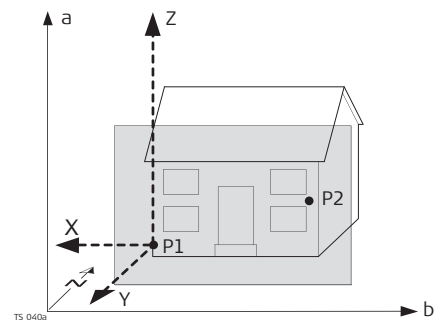
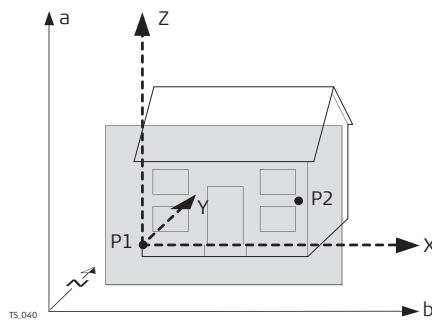

- a Height
- b Easting
- N Northing
- P1 Origin of plane
- P2 Point of plane
- X X axis of plane
- Y Y axis of plane
- Z Z axis of plane



With four or more points, a least squares adjustment is calculated resulting in a best fit plane.

Origin

The origin of the reference plane can be defined to be in the plane coordinates or in relation to the national coordinate system.

Grid orientation

The orientation of the grid is part of a reference plane. The orientation is defined during the reference plane definition and can be changed when editing a reference plane.

Positive direction of plane

The positive direction of the plane is defined by the direction of the Y axis. The direction of the Y axis can be redefined by selecting a point on the desired side of the plane.

Offset of the plane

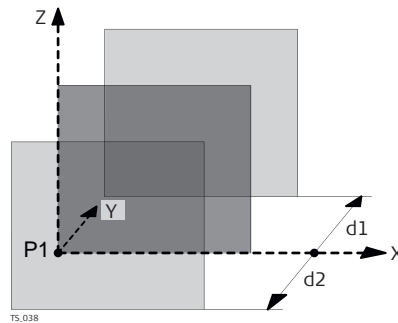

- P1 Origin of plane
- X X axis of plane
- Y Y axis of plane
- Z Z axis of plane
- d1 Positive offset
- d2 Negative offset

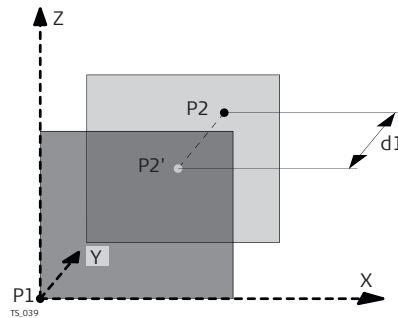

- P1 Origin of plane
- P2 Point defining offset of plane
- P2' P2 projected on original plane
- d1 Offset defined by P2
- X X axis of plane
- Y Y axis of plane
- Z Z axis of plane

42.2

Accessing Reference Plane & Grid Scan

Access

Select **Leica Captivate - Home: Meas plane/grid.**

Plane & Grid Scan

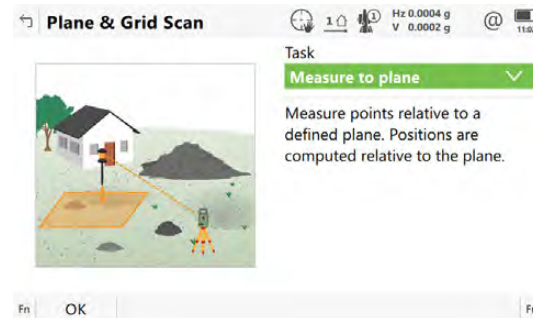

Key	Description
OK	To accept changes and to continue with the subsequent panel.
Fn Settings	To configure the reference plane. Refer to "42.5 Configuring Reference Plane & Grid Scan".

Description of the Reference Plane & Grid Scan tasks

Task	Description
Measure to plane	The coordinates of measured points are calculated relative to the reference plane.
Grid scan on plane	For TS: Measures a regular grid on a defined reference plane within a defined area.
Grid scan on surface	For TS: Measures any surface within a defined area.

Next step

IF	THEN
Task: Measure to plane or Grid scan on plane	<p>OK.</p> <ul style="list-style-type: none"> To create a plane by measuring points, enter a name for the reference plane. New points can be measured by starting the Measure app. To create a plane from previously stored points, enter a name for the reference plane. Refer to "42.3 Creating a Reference Plane From Previously Stored Points". For selecting an existing reference plane from a job, refer to "42.4 Selecting a Reference Plane from a Job". Only available when a reference plane has already been stored in the current job.
Task: Grid scan on surface	OK accesses Define Grid Scan Area . Refer to "42.9 Grid Scan on Surface - TS".

42.3

Creating a Reference Plane From Previously Stored Points

Access step-by-step

- In **Plane & Grid Scan**, select **Create a new plane from previously stored points**.
- Press **OK**.
- In **New Plane**, type in the name of the reference plane.
- Press **OK**.

New Plane, General page

New Plane Hz 0.0001 g V 0.0001 g 11:04

General Points 3D viewer

Plane name **333**

Number of points **0**

Standard deviation -----

Greatest distance of any point from plane -----

OK Page

Key	Description
OK	To continue to the next panel.
Page	To change to another page on this panel.

Description of fields

Field	Option	Description
Plane name	Display only	The name of the new reference plane.
Number of points	Display only	Number of points used for plane definition.
Standard deviation	Display only	Standard deviation of used points for plane definition. ----- is displayed unless more than four points are used to define the plane.
Greatest distance of any point from plane	Display only	Maximum distance between measured point and defined plane. ----- is displayed unless more than four points are used to define the plane.

Next step

Page changes to the **Points** page.

New Plane, Points page

- **Yes** is shown in the **Source point** metadata for a point which is used as origin of the plane.
- **!** is shown in the **Out of limit** metadata if the point is outside maximum distance between a point and the calculated plane as defined on the **General** page.
- Δd is the perpendicular distance of the point from the definition of the plane.

New Plane Hz 0.0010 g V 0.0002 g 11:06

General **Points** 3D viewer

TPS3	Dist diff (m) 0.000	Out of limit -----	Use Yes	Source point ---
TPS2	Dist diff (m) 0.000	Out of limit ---	Use Yes	Source point ---
TPS1	Dist diff (m) 0.000	Out of limit ---	Use Yes	Source point Yes

Fn OK Add point Use Delete Page Fn

Key	Description
OK	To continue to the next panel.
Add point	To add points from the job to define the reference plane. Available when creating a plane from previously stored points.
Use	To change between Yes and No in the Use for the highlighted point.
Delete	To remove the highlighted point from the list.
Meas app	To measure a point to be used for the plane. Available when creating a plane by measuring new points.
Page	To change to another page on this panel.

Next step

Page changes to the **3D viewer** page.

Plane Coordinate System

This panel is displayed if **Use local plane coordinate system** is checked in **Configuration, Parameters** page.

Key	Description
OK	To compute and store the reference plane.
Meas app	Available when Point is highlighted. To measure a point to define the plane direction.

Description of fields

Field	Option	Description
Current origin point	Display only	Point which has been selected as origin point.
X coordinate	Editable field	Enter local X coordinate of origin. The origin is defined as the projection of the measured point onto the calculated plane.
Z coordinate	Editable field	Enter local Z coordinate of origin. The origin is defined as the projection of the measured point onto the calculated plane.
Point	Selectable list	Defines the direction of the Y axis.

Plane Grid Orientation

Choose how you want to define the grid orientation on the reference plane.

Key	Description
OK	To continue to the next panel.

Description of fields

Field	Option	Description
Current origin point	Display only	Point which has been selected as origin point.
Use the fall line of the plane	Option button	The fall line is the line of greatest slope. The fall line is a curve following the steepest slope. It is always orthogonal to the contour lines. The gradient of the height determines the fall line mathematically.
Select a point of the plane besides the origin point	Option button	The origin point and another point on the reference plane define the orientation.
Orientation Point	Selectable list	Available when Select a point of the plane besides the origin point is selected. The point which defines the orientation together with the origin point.

Next step

OK changes to the **Offset of Plane**.

Offset of Plane

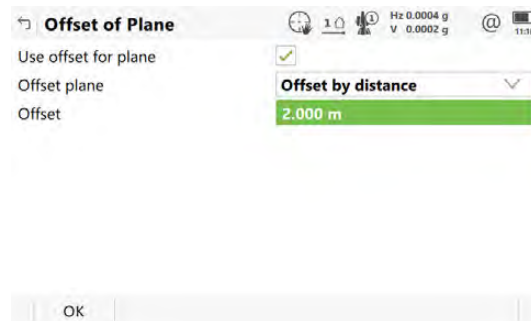

Key	Description
OK	To compute and store the reference plane.
Meas app	Available when Offset pt ID is highlighted. To measure a point to define the offset point.

Description of fields

Field	Option	Description
Offset plane	Selectable list	An offset is defined by a point or a distance. The defined plane is shifted along the Y axis by the offset.

Field	Option	Description
Offset pt ID	Selectable list	Available for Offset plane:Offset to a point . Point ID of offset point.
Offset	Display only or editable field	Distance by which to offset the plane along the Y axis. For Offset plane:Offset by distance , the distance can be entered. For Offset plane:Offset to a point , the calculated distance to the adjusted plane is displayed. ----- if no values are available.

42.4

Selecting a Reference Plane from a Job

Access

In **Plane & Grid Scan**, select **Select an existing plane**. Press **OK**. Highlight **Plane name**. Press **ENTER**.

Available if a reference plane has already been stored in the current job.

Planes in Job



Key	Description
OK	To select the highlighted reference plane.
Delete	To delete the highlighted reference plane.

Description of metadata

Information about date and time of when the reference plane was created and the number of points defining the plane.

42.5

Configuring Reference Plane & Grid Scan

Description

Allows options to be set which are used within the app. These settings are stored within the working style.

Access

Select **Leica Captivate - Home: Meas plane/grid**.
Press **Fn Settings**.

Configuration, Parameters page

Configuration Hz 0.0004 g V 0.0002 g 11:21

Parameters Report sheet

Show user defined page

Page to show **Measure**

Maximum distance difference for defining plane **0.300 m**

Max distance difference for grid scan on plane **0.300 m**

Use local plane coordinate system

OK Page

Key	Description
OK	To accept changes and return to the panel from where this panel was accessed.
Edit	To edit the page currently being displayed. Available when a list item in Page to show is highlighted. Refer to "26.2 User defined pages ".
Page	To change to another page on this panel.
Fn About	To display information about the app name, the version number, the date of the version, the copyright and the article number.

Description of fields

Field	Option	Description
Show user defined page	Check box	When this box is checked, pages can be selected.
Page to show	Selectable list	The names of the available pages.
Maximum distance difference for defining plane	Editable field	The maximum perpendicular deviation of a point from the calculated plane.
Max distance difference for grid scan on plane	Editable field	For TS: The maximum perpendicular deviation of a measured point in grid scan on plane from defined plane. Measured points outside the defined limit are not stored.
Use local plane coordinate system	Check box	When this box is checked, then point results are additionally stored with X, Y, Z coordinates based on the local plane coordinate system. The panel Plane Coordinate System is displayed in the reference plane definition workflow. Local coordinates and the positive direction of the reference plane can be defined. When this box is not checked, then points on the plane are transformed into the global coordinate system.

Next step

Page changes to the **Report sheet** page. Refer to "36 Apps - General".

42.6

Editing a Reference Plane

Access

After creating or selecting a reference plane, select **Edit plane currently being used** in **Measure to Plane** or **Grid Scan on Plane**.

Edit Plane, General page

Key	Description
OK	To compute and store the reference plane.
Page	To change to another page on this panel.

Description of fields

Field	Option	Description
Plane name	Editable field	The name of the reference plane.
Number of points	Display only	Number of points used for plane definition.
Standard deviation	Display only	Standard deviation of used points for plane definition. ----- is displayed unless more than four points are used to define the plane.
Greatest distance of any point from plane	Display only	Maximum distance between measured point and defined plane. ----- is displayed unless more than four points are used to define the plane.

Next step

Page changes to the **Points** page.

Edit Plane, Points page

- ✓ is shown in the **Source point** metadata for a point which is used as origin of the plane.
- ! is shown in the **Out of limit** metadata if the point is outside maximum distance between a point and the calculated plane as defined on the **General** page.
- Δd is the perpendicular distance of the point from the definition of the plane.

Key	Description
OK	To compute and store the reference plane.
Add point	To add points from the job to define the reference plane.
Use	To change between Yes and No for the highlighted point.
Delete	To remove the highlighted point from the list.
Meas app	To measure a point to be used for the plane.
Page	To change to another page on this panel.

Next step

Page changes to the **Origin** page.

Edit Plane, Origin page

Key	Description
OK	To compute and store the reference plane.
Meas app	Available when Point is highlighted. To measure a point to define the plane direction.
Page	To change to another page on this panel.

Description of fields

Field	Option	Description
Use local plane coordinate system	Check box	When this box is checked, then point results are additionally stored with X, Y, Z coordinates based on the local plane coordinate system. When this box is not checked, then points on the plane are transformed into the global coordinate system.
Current origin point	Display only	The point which has been selected as origin point.
X coordinate	Editable field	Enter local X coordinate of origin. The origin is defined as the projection of the measured point onto the calculated plane.
Z coordinate	Editable field	Enter local Z coordinate of origin. The origin is defined as the projection of the measured point onto the calculated plane.
Point	Selectable list	Defines the direction of the Y axis.

Next step

Page changes to the **Orientation** page.

Edit Plane, Orientation page

Choose how you want to define the grid orientation on the reference plane.

Key	Description
OK	To continue to the next panel.

Description of fields

Field	Option	Description
Current origin point	Display only	Point which has been selected as origin point.
Use the fall line of the plane	Option button	The fall line is the line of greatest slope. The fall line is a curve following the steepest slope. It is always orthogonal to the contour lines. The gradient of the height determines the fall line mathematically.
Select a point of the plane besides the origin point	Radio button	The origin point and another point on the reference plane define the orientation.

Field	Option	Description
Orientation Point	Selectable list	Available when Select a point of the plane besides the origin point is selected. The point which defines the orientation together with the origin point.

Next step

Page changes to the **Offset** page.

Edit Plane, Offset page

Key	Description
OK	To compute and store the reference plane.
Meas app	Available when Offset pt ID is highlighted. To measure a point to define the offset point.
Page	To change to another page on this panel.

Description of fields

Field	Option	Description
Use offset for plane	Check box	When this box is checked, an offset can be defined for the reference plane.
Offset plane	Selectable list	An offset is defined by a point or a distance. The defined plane is shifted along the Y axis by the offset.
Offset pt ID	Selectable list	Available for Offset plane:Offset to a point . Point ID of offset point.
Offset	Display only or editable field	Distance by which to offset the plane along the Y axis. For Offset plane:Offset by distance , the distance can be entered. For Offset plane:Offset to a point , the calculated distance to the adjusted plane is displayed. ----- if no values are available.

Next step

The **3D viewer** page shows a graphical view of the reference plane.

42.7

Measuring Points to a Reference Plane

Access

After creating or selecting a reference plane, select **Measure to plane** in **Measure to Plane**.

Measure Points to Plane, page

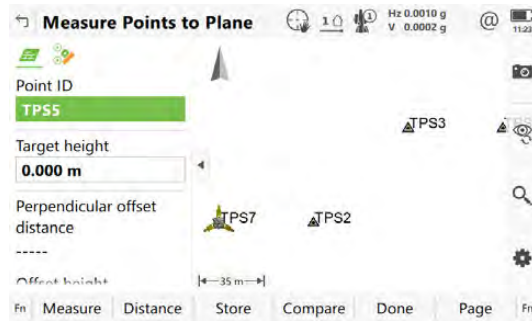

Key	Description
Measure	For GS: To start measuring the point. The key changes to Stop . The difference between the current position and the adjusted plane is displayed.
Stop	For GS: To end measuring the point. The key changes to Store . After ending the measurement, the differences between the measured point and the adjusted plane are displayed.
Measure	For TS: To measure a distance and store distance and angles.
Distance	For TS: To measure a distance.
Store	To store the point information.
Compare	To calculate offsets to previously measured points.
Done	To finish measuring points.
Fn Tools	Refer to "37 Apps - The Toolbox".

Description of fields

Field	Option	Description
Point ID	Editable field	The number of the measured point.
Target height	Editable field	For TS: The target height.
Antenna height	Editable field	For GS: The height of the antenna.
Perpendicular offset distance	Display only	The perpendicular distance between the measured point and the adjusted plane.
Offset height	Display only	The vertical distance between the measured point and the adjusted plane.
X coordinate, Y coordinate, Z coordinate	Display only	Available when Use local plane coordinate system is checked in Edit Plane, Origin .

Field	Option	Description
Easting, Northing, Height	Display only	Available when Use local plane coordinate system is not checked in Edit Plane, Origin .

42.8

Grid Scan on Plane - TS

Description

Grid scan on plane automates the process of measuring a sequence of points along the defined vertical, tilted or horizontal reference plane. The window of interest can be either rectangular or polygonal. The boundaries of the window of interest and the increment values can be defined. Grid scan on plane can be run on instruments with the option "reflectorless EDM" only.

Access step-by-step

1. After creating or selecting a reference plane, select **Grid scan plane** in **Grid Scan on Plane**.
2. Press **OK**.
3. Choose between:
 - **Rectangular area:** Two opposite corner points define the rectangular grid scan area. The area must be defined from the first to the second point. Grid scan areas bigger than 180° are not allowed.
 - **Polygonal area:** Three or more clockwise measured points define the polygonal grid scan area. The polygonal grid scan area is calculated based on the sequence of the points. Grid scan areas bigger than 180° are not allowed.
4. Press **OK**.

Diagram

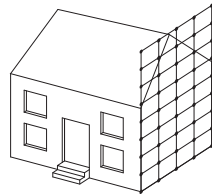

TS.120



Known

PO Setup

Unknown

Grid point coordinates

Measure corner

For a rectangular grid scan area, measure two points at opposite corners.
For a polygonal grid scan area, measure all corner points in consecutive order.

Key	Description
OK	To either measure another corner point of the grid scan area or to start grid scanning the area.
Done	For polygonal areas, this key appears for the first time after the third measured point.
Page	To change to another page on this panel.

Key	Description
ESC	To delete the last measured point of the rectangular or polygonal grid scan area. If necessary, remeasure scan area points.

Grid Scan Settings, Define grid spacing on the plane.

Description of fields

Field	Option	Description
Left / right	Editable field	For tilted and vertical planes. Horizontal grid distance.
Up / down	Editable field	Up slope grid distance.
Grid scan area	Display only	Size of the grid scan area.
Estimated points	Display only	Estimated number of points to be grid scanned. >20'000 is shown for all resolution bigger than 20'000 points.  It is not checked if all points from the scan resolution fall within the defined grid scan area. For more than 20'000 points, grid scanning the defined grid scan area with the selected resolution may take long.
Also measure the boundary of the defined scan area	Check box	When this box is checked, the boundary of the grid scan area is also measured.

Grid Scan Settings, Define start point ID & increment.

Description of fields

Field	Option	Description
Start point	Editable field	The point ID to start with.
Increment	Editable field	The incrementation used for Start point . No point ID template used <ul style="list-style-type: none"> For Start point: RMS and Increment: 10 the points are RMS, RMS10, RMS20, ..., RMS100, ... For Start point: 100 and Increment: 10 the points are 100, 110, ..., 200, 210, ... For Start point: abcdefghijklmn89 and Increment: 10 the points are abcdefghijklmn99, point ID incrementing fails.

Grid Scan Settings, Choose the grid scan mode to be used.

This panel is only displayed for motorised instruments. For all other instrument types, the standard measurement mode is set.

Description of fields

Field	Option	Description
Standard - accuracy & range optimised	Check box	This measurement mode is accuracy and range optimised. It uses single distance measurements to any surface.
Fast - speed & performance optimised	Check box	This measurement mode is speed and performance optimised. It uses continuous distance measurements to any surface.

Grid Scan Status

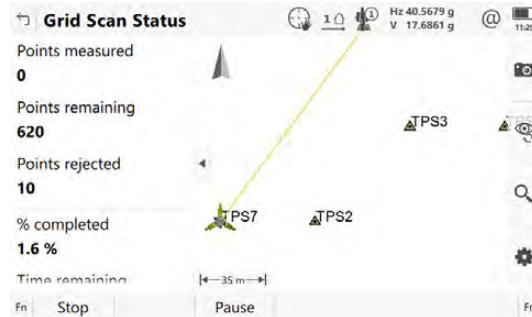

Key	Description
Stop	To stop the grid scanning of points.
Pause	To pause the grid scanning of points.
Scan	To continue grid scanning.

Description of fields

Field	Option	Description
Points measured	Display only	Number of points being measured.
Points remaining	Display only	Number of points remaining to be grid scanned.
Points rejected	Display only	Number of skipped points.
% completed	Display only	Percentage of points measured.
Time remaining	Display only	Estimated time remaining until grid scan is finished.
Point ID	Display only	Point ID of last stored point.

Next step

In 3D viewer, points currently scanned are displayed in black, previously measured points and lines are displayed in grey.

Description

Grid Scan on Surface allows the measurement of a grid on any surface based on an angular resolution (constant delta horizontal and delta vertical values). No reference plane is required. The grid scan area can be either rectangular or polygonal. Optionally, the boundary of the grid scan area can be measured. Grid Scan on Surface can be run on instruments with the option "reflectorless EDM" only.

Diagram

TS.121



P0

Known

P0 Setup

Unknown

Grid point coordinates

Access step-by-step

1. In **Plane & Grid Scan**, select **Grid scan on surface**.
2. Press **OK**.
3. Choose between:
 - **Rectangular area:** Two opposite corner points define the grid scan area. The area must be defined by pointing the instrument to opposite corners of the area. Grid scan areas bigger than 180° are allowed.
 - **Polygonal area:** Three or more clockwise measured points define the grid scan area. The polygonal grid scan area is calculated based on the sequence of the points. Grid scan areas bigger than 180° are allowed.
4. Press **OK**.



Most steps are identical with the steps for **Grid scan on plane**. Refer to "42.8 Grid Scan on Plane - TS" for a description of the panels.

**Surface Scan Settings,
Define grid scan spacing.**

Key	Description
OK	To continue with the next panel.
Distance	Available when Define spacing by: Distances is selected. To take a distance measurement to any surface. The measured value is displayed in the Horizontal distance field.

Description of fields

Field	Option	Description
Define spacing by	Angles	Horizontal and vertical angle values define the scan resolution.
	Distances	Horizontal and vertical spacings at a certain range define the scan resolution.
Hz and V	Editable field	Available for Define spacing by: Angles . The horizontal and vertical angle values defining the scan resolution.
Horizontal distance	Editable field	Available for Define spacing by: Distances . The range for which the horizontal and vertical spacings are valid.
Horizontal spacing and Vertical spacing	Editable field	Available for Define spacing by: Distances . The horizontal and vertical spacing defining the scan resolution at the defined range.
Estimated points	Display only	The number of points to be scanned according to the defined scan resolution. >20'000 is displayed for all scan resolution exceeding 20'000 points.
		 It is not checked if all points from the scan resolution fall within the defined grid scan area. For more than 20'000 points, grid scanning the defined grid scan area with the selected resolution may take long.
Also measure the boundary of the defined scan area	Check box	When this box is checked, then the boundary of the grid scan area is also measured.



Please be aware that the terminology or workflow used on different construction sites can vary from the one used in this manual. However, basic principles remain the same.

Description

Name	Description
Alignment editor	<ul style="list-style-type: none"> Alignment Editor is an "add-on" component. It is only intended for quick and easy modification of existing alignments, or creation of new ones. Alignment editor is not an onboard road planning and design app. This app supports the following alignment types: <ul style="list-style-type: none"> Horizontal alignments Vertical alignments Cross section templates Cross section assignments Chainage equations This app is a free app provided by Leica Geosystems AG. If the app does not appear on your menu or you are otherwise unable to access it, contact your Leica Geosystems AG representative.
Roads	<ul style="list-style-type: none"> This subapp allows the measuring and staking of roads and other alignments. It can be used with GS and with TS. It consists of two main functions: <ul style="list-style-type: none"> Check road for checking or measuring existing lines, surface grade, slopes or surfaces and comparing the measurements against design data. Stake road for setting or staking out and adjusting road elements during construction using design data. The data can be typed in manually by using the Alignment editor app or data created in a design package can be converted. The Import data functionality in the job menu and the Design to Field component of Infinity offer converters from several road design and CAD packages.
Rail	<ul style="list-style-type: none"> This subapp allows the measuring and staking of railways and other alignments. It can be used with GS and with TS. It consists of two main functions: <ul style="list-style-type: none"> Check rail for checking or measuring an existing track and comparing the measurements against design data. Stake rail for setting or staking out and adjusting track features during construction using design data.

Name	Description
	<ul style="list-style-type: none"> • Single track or multiple track designs can be imported for use with this app. <ul style="list-style-type: none"> • For horizontal and vertical alignments, the data can be typed in manually by using the Alignment editor app. Data created in a design package can be converted. • For multiple track designs, it is possible to define one centreline which is common to all tracks. • A superelevation table can be created for each track using the Rail Editor computer app. This app is part of the Design to Field component in Infinity.
Tunnel	<ul style="list-style-type: none"> • For TS. • This subapp allows the measuring and staking of tunnels. • It consists of two main functions: <ul style="list-style-type: none"> • Check tunnel for checking a built or excavated tunnel with a tunnel design. • Stake tunnel for staking out tunnel features during construction. • The centreline of the tunnel can be imported for use onboard the instrument using the industry standard LandXML data format. Alternatively the centreline can be imported in formats exported from many other tunnel design packages using the Design to Field component of the Infinity. • Tunnel design profiles can be created using the Tunnel Profile Editor computer app. This app is integrated into the Design to Field component in Infinity.



Roads, Rail and Tunnel subapps are licence protected. They can be activated through a licence key which is specific to the instrument. Refer to "29.3 Load licence keys".

43.2

Jobs & Design Data

43.2.1

Accessing Roads Apps

Access

Select one of the Road apps from the **Leica Captivate - Home** menu:

- **Stake road**
- **Check road**
- **Stake rail**
- **Check rail**
- **Stake tunnel**
- **Check tunnel**

43.2.2

Working with a DTM Job

Access

In the job selection panel check **Use a DTM**.

Open the selectable list for **DTM**.

Design data for Road**2D and 3D lines**

Depending on the method to be used, the design in all road jobs must consist of either 2D or 3D lines.

2D lines are required at least when working with lines, local lines, manual slope, local manual slope or layer. If the design consists of 2D lines, heights can be considered manually.

3D lines are required when working with slope, surface grade or crown. 3D lines can also be used when working with lines, local lines, manual slope, local manual slope or layer.

Description

Depending on the complexity of the road job, the design data can vary from a single horizontal alignment to a design containing profiles with dozens of defined vertices. Design elements can be grouped logically for faster access.

Lines

When manually typing in a road job, alignments and cross sections are used. Alignments are defined by geometric elements, for example straights and arcs, and the cross sections by vertices. Furthermore, at which chainage a certain cross section is used is also defined. By defining these elements the vertices are connected to create a series of lines representing the three-dimensional design of the road.

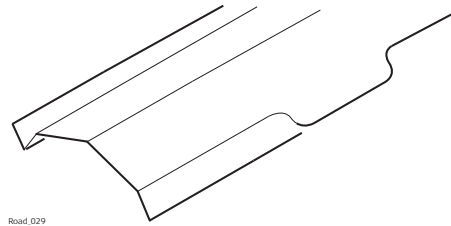

Road_029

Line representation of a road design.

Such lines defining the design are called lines. Lines are the base elements used for stakeout and check activities. Lines have a project unique name by which they are identified and selected. Whenever a new road design is typed in or imported from a design package these lines are generated automatically in the background.



A cross section can be derived from the line model by slicing the group of lines with a vertical plane orthogonal to the centreline.

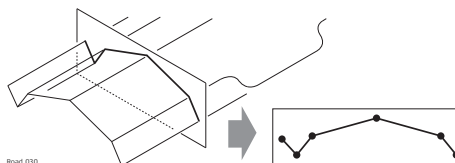

Road_030

Vertical cut of a line group defines a cross section.



Lines are referenced by layers and can be used in more than one layer.



Every layer is relative to a centreline. This centreline does not have to be a part of the layer. In the previous example, layer one - general fill - uses the centreline for calculation even though the centreline is not part of the layer surface. Whereas the centreline is part of layer three - final surface.

Design data for Rail

Horizontal and vertical alignments

All rail jobs must consist of at least one horizontal alignment. Each horizontal alignment can either be typed in manually using the **Alignment editor** app, or converted from a rail design package using **Import data** from the job menu or the Design To Field component within the Infinity.

Horizontal alignments can consist of straights, circular curves, clothoid, parabolic curves and blossom curves.

Vertical alignments can consist of straights, circular curves and parabolic curves.

If a design comprises multiple tracks, one horizontal alignment can be defined as the chainage centreline. From the chainage centreline, all chainages are calculated and horizontal and vertical alignments can be used to define each track.

Rail definition

Define rails by:

- Entering the design data manually in the field
- Using the **Alignment editor** to define the centreline only
- Using **Import data** from the job
- Converting data from a rail design package using the Design To Field component and if necessary the Rail Editor (for defining the superelevation) component within the Infinity program

Rails are stored as continuous 2D or 3D lines within the rail job.

Tracks

Tracks are used to group related centreline and rails together.

For single tracks, the track centreline and the two rails are grouped in one track.

For multiple tracks where one chainage centreline is used for all tracks, each track consists of four lines: the track centreline, the chainage centreline and the left and right rails.

For multiple tracks where chainage is calculated relative to the track centreline, each track is stored as a single track as described previously.

Design data for Tunnel

Horizontal and vertical alignments

All tunnel jobs must consist of at least a horizontal and a vertical alignment. These data can be converted from a road design package using the Design To Field component within Infinity.

Profiles

Depending on the complexity of the tunnel job, the design data can vary from a single horizontal and vertical alignment to a design containing many different design profiles with dozens of defined vertices.

Design profiles can be defined and edited using the Design To Field component within the Infinity.

Layers

Tunnels generally consist of layers made of different materials, for example a shotcrete surface or a lining. At different times throughout a project, it may be required to work with different layers of the tunnel.

The Tunnel Profile Editor allows the possibility of creating such layers by grouping design profiles that are used at the same chainage.

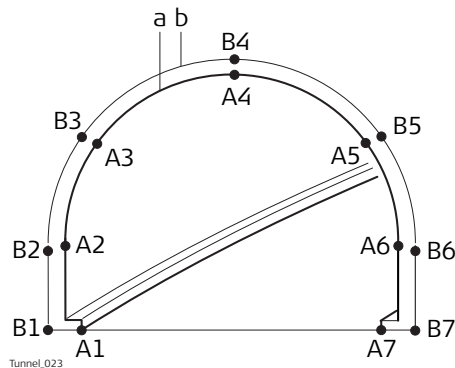

- a The vertices **A1-A7** could be grouped in a layer (**a**) and represent the final lining of the tunnel.
- b The vertices **B1-B7** could be grouped in a layer (**b**) and represent the inner shotcrete layer of the tunnel.

Design Profile Layers can be assigned to chainages along the centreline using the Tunnel Profile Editor within the Design To Field component.

The layer of the tunnel to stake out or check can be defined when creating a task.

43.2.4

Viewing and Editing the Design Data

Access

In the **Design Data** panel, check **Use a road design**, **Use a rail design** or **Use a tunnel design**.

Open the selectable list for the job.

In **Road Design/Rail Design/Tunnel Design**, highlight a job and press **Data**.

View & Edit Data

The design data stored within the road/rail/tunnel job contains all information about the road/rail/tunnel design. This information includes the lines and layers, for example, the geometry of the centreline or the layers of the different

materials/surfaces which form the road/tunnel. The design data can be viewed and partially edited on this panel.

View & Edit Data

Job name: Soccer_3D+2D_lines

Layer: Test Strings

Number of lines: 9

Centreline: Centreline

Chainage: 100.000 m

Ch increment: 10.000 m

Buttons: Fn, OK, Edit, View, Fn

Key	Description
OK	To return to the job selection.
Edit	To edit the general job details and the start chainage of the centreline of the selected layer. For Road additionally to select another centreline and include/exclude lines from the selected layer.
View	To view geometry details of the lines and to view cross section plots. For Road and Rail additionally to view the list of all lines in the layer.
Fn Settings	To access the settings. Refer to "43.3 Configuring Roads Apps".

Description of fields

Field	Option	Description
Job name	Display only	The name of the active road/rail/tunnel job, as selected in the job selection panel.
Layer	Display only	To select a layer from the active road/rail/tunnel job. All layers within the active road/rail/tunnel job can be selected.
Number of lines	Display only	Available for Road and Rail. The number of lines from the selected layer.
Number of profiles	Display only	Available for Tunnel. The number of profiles from the selected layer.
Centreline	Display only	The name of the layer centreline.  Every layer must have a centreline.
Chainage	Editable field	To enter chainage to use when viewing the data. The default value is the start chainage of the layer centreline.
Ch increment	Editable field	To enter a chainage increment to use when stepping through the data.

Next step

IF you want to	THEN press
edit data	Edit. Refer to "Edit design data,Layer page".
view data	View. Refer to "View design data,Line information page".

Edit design data, Layer page

Only available for Road.



Key	Description
Store	To store data and return to the previous panel.
Centre	To set the highlighted line as centreline.
Use	To set Yes or No in the metadata for excluding/including the highlighted line of selected layer.
Page	To change to the next page.
Fn All or Fn None	To change the setting for the Use metadata for all lines at once.  Deactivates also the centreline.

Description of metadata

Metadata	Description
-	The name of all the lines in the layer.
Centreline	Shown for the line selected as centreline.
Use	For Yes : The selected line is used for stake/check. For No : The selected line is not used for stake/check. Stringlines with this status are drawn in 3D viewer, but they are not included in the profile.

Metadata	Description
----------	-------------



0014334_001

- a Lines with status **No** excluded from profile
- b Lines with status **Yes** excluded from profile

Next step

Page changes to the **Centreline** page.

Edit design data, Centreline page



Key	Description
Store	To store changes and return to the previous panel.
Reset	To clear all changes made and to reset to the original start chainage. The original start chainage is always remembered.
Page	To change to the next page.

Description of fields

Field	Option	Description
Centreline	Display only	The name of the centreline.
Set start chainage	Editable field	To enter a start chainage for the layer centreline.
End chainage	Display only	The end chainage of the layer centreline. The end chainage is automatically calculated using the centreline length.

Next step

Store to store the changes.

View to the design data.

View design data, Line information page

If a value is unavailable in the design data, the field is shown as -----.

Line information Lines 3D viewer

Line name	Centreline
Chainage	100.000 m
Easting	-19846.790 m
Northing	5301045.974 m
Height	-----
Hz tangent	374.7362 g
Hz radius	-----

Fn OK Ch - Ch + Segment Vt Page Fn

Key	Description
OK	To return to the previous panel.
Ch -	To decrease the chainage by the chainage increment, as defined in the View & Edit Data panel.
Ch +	To increase the chainage by the chainage increment, as defined in the View & Edit Data panel.
Segment	To access Segment Info - Start Point .
Hz or Vt	To change between the vertical alignment data and the horizontal alignment data.
Page	To change to another page on this panel.

Description of fields

Field	Option	Description
Line name	Selectable list	All lines available at the defined chainage are displayed and can be selected.
Chainage	Editable field	To enter chainage to use when viewing the data. The default value is the start chainage of the layer centreline.
Easting, Northing and Height	Display only	The East/North coordinate and height of the line at defined chainage.
Hz tangent	Display only	The tangent direction of the line at defined chainage.
Grade	Display only	The grade of the line at defined chainage.
Hz radius	Display only	The horizontal radius of the line segment at defined chainage.
Vertical radius	Display only	The vertical radius of the line segment at defined chainage.

Field	Option	Description
Hz type	Display only	The horizontal segment type at defined chainage.
Vertical type	Display only	The vertical segment type at defined chainage.
Hz offset	Display only	The horizontal offset to the layer centreline at defined chainage.
Vertical offset	Display only	The vertical offset to the layer centreline at defined chainage.

Next step

Page to change to the **Lines** page.

View design data, Lines page

Unavailable for Tunnel.

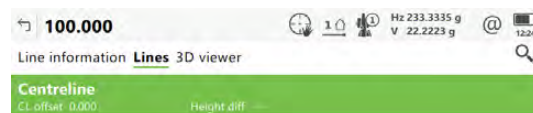

Key	Description
OK	To return to the previous panel.
Ch -	To decrease the chainage by the chainage increment, as defined in the View & Edit Data panel.
Ch +	To increase the chainage by the chainage increment, as defined in the View & Edit Data panel.
Segment	To access Segment Info - Start Point .
More	To change between the height differences or absolute heights at the selected chainage.
Page	To change to another page on this panel.

Description of metadata

Metadata	Description
-	The name of the lines available at defined chainage in the selected layer.
CL offset	The horizontal offset of the line from the layer centreline.
Height diff	The height difference of the line to the layer centreline.
Height	The absolute height of the line.

Next step

Page to change to the **3D viewer** page.

The **3D viewer** page shows a 2D, 3D, cross section and long section view of the design data at the selected chainage.

Segment to access **Segment Info - Start Point/Segment Info - End Point**.

Segment Info - Start Point/ Segment Info - End Point, Hz alignment page

If a value is unavailable in the design data, the field is shown as -----.

Key	Description
OK	To return to the previous panel.
Segment -	To move to the previous segment.
Segment +	To move to the next segment.
End point or Start point	To change between the start point and the end point of the segment.
Page	To change to another page on this panel.

Key	Description
OK	To return to the previous panel.
Segment -	To move to the previous segment.
Segment +	To move to the next segment.
End point or Start point	To change between the start point and the end point of the segment.
Page	To change to another page on this panel.

Description of fields

Field	Option	Description
Line name	Display only	The name of the selected line.
Chainage	Display only	The chainage of start/end point of the segment.
Easting, Northing and Height	Display only	The East/North coordinate and height of the start/end point of the segment.
Hz tangent	Display only	The tangent direction at the start/end point of the segment.
Hz radius	Display only	The radius at the start/end point of the segment.
Hz type	Display only	The current segment type.

Next step

Page to change to the **Vertical alignment** page.

**Segment Info - Start Point/
Segment Info - End Point,
Vertical alignment page**

Refer to "Segment Info - Start Point/Segment Info - End Point,HZ alignment page" for a description of keys.

If a value has not been defined, the field is shown as -----.

Description of fields

Field	Option	Description
Line name	Display only	The name of the selected line.
Chainage	Display only	The chainage of start/end point of the segment.
Easting, Northing and Height	Display only	The East/North coordinate and height of the start/end point of the segment.
Grade	Display only	The grade at the start/end point of the segment.
Vertical radius	Display only	The radius at the start/end point of the segment.
Vertical type	Display only	The current segment type.

Next step

OK returns to the previous panel.

43.3

Configuring Roads Apps

43.3.1

Configuration Settings

Access

Select one of the Road apps from the **Leica Captivate - Home** menu.
In the **Task** press **Fn Settings**.

**Road Settings,
Quality control page**

Description

Especially when checking points in an as-built control or when staking out it is useful to enable the **Quality control** criteria available. For every point stored, the chosen parameters are checked and if the check limits are exceeded a warning is shown. This function guarantees a higher productivity as it is no longer necessary to check the values for every shot taken. Checking layers of a road, a layer that is too thick results in higher costs as more material is used. Alternatively, a too thin layer can lead to problems and could cause serious damage. Therefore different check limits for above and below the design can be defined.

Graphic

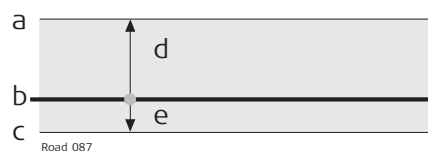

- a Layer is too thick
- b Design surface
- c Layer is too thin
- d **Upper height limit**
- e **Lower height limit**

Height limits below the design surface are entered as negative values. For example, the **Lower height limit** with -10 mm in the previous diagram. Using the signs of the height limits, it is also possible to cover situations like the one shown in the following diagram, with a valid range between -10 to -50 mm below the design surface.

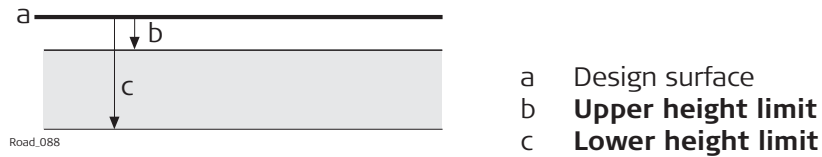

Description of fields

Field	Option	Description
Check differences before storing	Check box	When this box is checked, a position check is done when storing a staked or checked point. When the defined tolerance is exceeded, the stake out/check can be repeated, skipped or stored. When this box is not checked, no quality check is done during stake out/check of points.
Differences to check		<p> Depending on this selection the following lines are enabled/disabled.</p> <p>Chainage, offset & height Check for chainage, horizontal offset and height.</p> <p>Chainage & offset Check for chainage and horizontal offset.</p> <p>Position & height Check for 2D position and height.</p> <p>Position Check for 2D position.</p> <p>Height Check for height.</p> <p>Profile Available for Tunnel. Check for distance from design profile.</p>
Chainage limit	From 0.001 to 100	Maximum difference in chainage.
Offset limit	From 0.001 to 100	Maximum horizontal offset from defined position.
Position limit	From 0.001 to 100	Maximum radial horizontal distance.
Upper height limit	From -100 to +100	Maximum height difference.
Lower height limit	From -100 to +100	Maximum height difference.
Profile tolerance	From 0.001 to 100	Available for Tunnel. Permitted distance from design profile.

Next step

Page changes to the **Graphics** page.

Road Settings, Graphics page

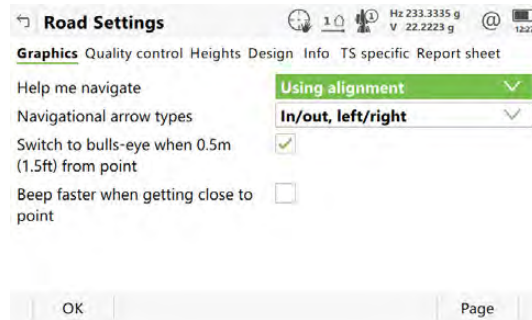

Key	Description
OK	To confirm the changes and move to the previous panel.
Page	To change to another page on this panel.
Fn About	To display information about the app name, the version number, the date of the version, the copyright and the article number.

Description of fields

Field	Option	Description
Help me navigate		The reference direction used to stakeout points. The stakeout elements and the graphics displayed are based on this selection. Applies to the Stake view ()
	Using alignment	The direction of the orientation is relative to the alignment.
	From behind instrument	Available for TS. The direction of the orientation is from the instrument to the point to be staked.
	Facing instrument	Available for TS. The direction of the orientation is from the current position relative to the instrument.
	Facing point (design data)	The direction of the orientation is from the current position relative to a point from the design job.
	Facing point	The direction of the orientation is from the current position relative to the last recorded point. If no points are yet staked, Help me navigate: Facing north is used for the first point to be staked.
Facing north	The direction of the orientation is from the current position relative to North.	

Field	Option	Description
	Following arrow	The direction of the orientation is from the current moving direction to the point to be staked. The graphical display shows an arrow pointing in the direction of the point to be staked. The current position must have moved at least 0.5 m for the orientation to be calculated.
	Facing sun	For GS: The position of the sun calculated from the current position, the time and the date.
Point ID	Selectable list	Available for Help me navigate: Facing point (design data) . To select the point or line to be used for orientation.
Navigational arrow types		The method of staking out.
	Direction & distance	The direction from the orientation reference, the horizontal distance and the cut/fill are displayed.
	In/out, left/right	The distance forwards to/backwards from the point, the distance right/left to the point and the cut/fill is displayed.
Switch to bulls-eye when 0.5m (1.5ft) from point	Check box	When this box is checked, a bulls eye bubble is shown in the stakeout graphic when less than half a metre from the point being staked.
Beep faster when getting close to point	Check box	The instrument beeps when the distance from the current position to the point to be staked is equal to or less than defined in Start within . The closer the instrument is to the point to be staked the faster the beeps are.
Distance to use	Height, Horizontal distance or Position & height	Available when Beep faster when getting close to point is checked. The type of distance to use for the stake beep.
Start within	Editable field	Available when Beep faster when getting close to point is checked. The horizontal radial distance, from the current position to the point to be staked, when a beep is to be heard.

Next step

Page changes to the **Heights** page.

Road Settings,
Heights page



The following field is shown in the Stake and Check methods except for **Slope** and **Manual slope**.

Description of fields

Field	Option	Description
Allow editing the height of the location being staked	Check box	When this box is checked, a height value typed in manually is used instead of design height or DTM height. When this box is not checked, the height from design is used.

Next step



Page changes to the **Design** page.

Description of fields

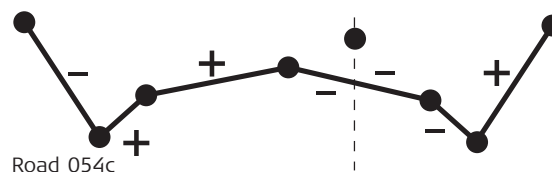
Field	Option	Description
Working corridor	Editable field	Valid offset range defined by the working corridor left and right of the centreline. If a measured point is further away from the working corridor distance, an error message is displayed. Refer to "43.6 Understanding Terms and Expressions" for more information on the working corridor.
Show tangent points	Check box	When this box is checked, a message box is shown when a tangent point (PI or PVI) has been detected within the chainage increment range. This tangent point can be selected for stakeout. When this box is not checked, no tangent points are indicated.
Type		Available when Show tangent points is checked.
	Horizontal	Indicates tangent points of the horizontal alignment only.
	Vertical	Indicates tangent points of the vertical alignment only.
	Horizontal & vertical	Indicates all tangent points.
Slope signs		Available for Road only. Selects sign definition method for slopes and surface grades.
	Mathematical	All slope signs defined from left to right, independent of whether left or right of the centreline.

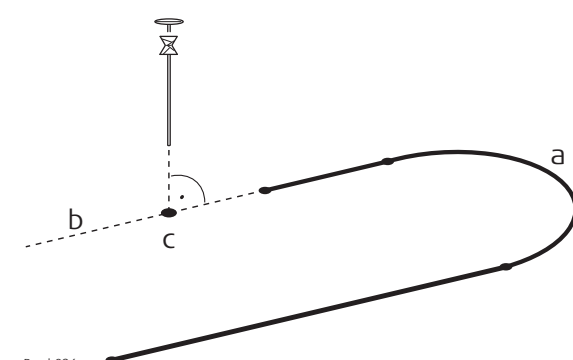
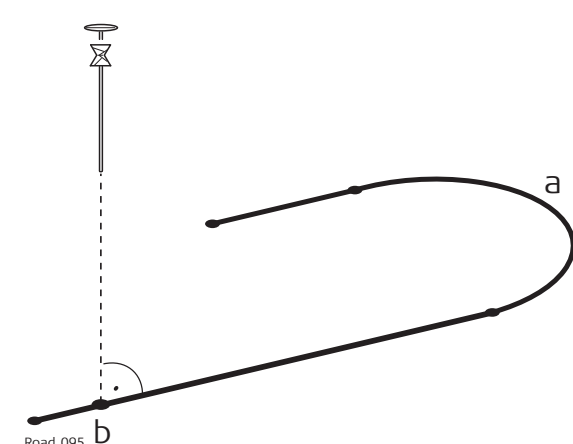

Field	Option	Description
	Relative to centreline	<p>Slope signs defined relative to the centreline.</p> <p>Road_054a</p>
	Relative from centreline	<p>Slope signs defined relative from the centreline.</p> <p>Road_054b</p>
Extend slopes		<p>When using slopes generated by a design package, the quality of the change from cut to fill or where slopes start and end, depends on the terrain model used for the project. Occasionally, one of the lines defining the slope ends before intersecting with the natural surface. A message appears asking to extend the slope, as soon as a measurement is taken outside of the defined design slope.</p>
	Yes (show message)	The slope is expanded beyond and above or below the hinge point. A warning is shown as soon as leaving the defined slope.
	Yes	The slope is expanded beyond and above or below the hinge point. No warning is when leaving the defined slope.
	No	The slope is not expanded beyond and above or below the hinge point.
Allow measuring beyond design	Check box	Extend each line or curve at its beginning and end with a tangent. The extension is used for projecting a point to the line and for intersecting the line.

Field	Option	Description
	Checked	<p>Intersection points on extended lines/curves are not shown in cross sections and cannot be staked out.</p>  <p>a Any type of line or curve b Extended line c Projected point on extended line</p>
	Not checked	<p>This option is recommended when working with closed alignments, for example roundabout, slip road, motorway exit.</p>  <p>a Any type of line or curve b Projected point on line</p>
Apply scale to horizontal design	Check box	<p>When this box is not checked, no scale factor is applied to length values. Length values are displayed in the grid format.</p> <p>When this box is checked, a defined scale factor is applied to length values. All distance values (chainages, chainage increments, offsets, Δ chainage, Δ offset, Δ height, ...) are displayed in ground using the Scale factor.</p> <p> The Road job data is still in grid format.</p>

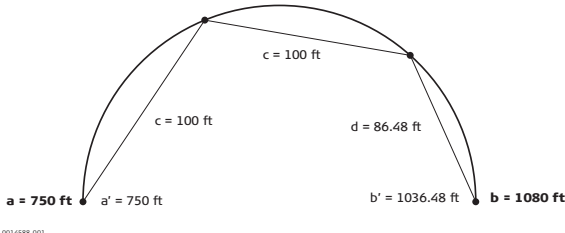
Field	Option	Description
		 All data is saved to the DBX in ground format. Only ground data is written to the report sheet.
Scale factor	Editable field	To apply an appropriate geodetic map projection to scale over the ground. The scale factor is only applied to Road, not to Rail or Tunnel.
Calculate chainage along chord	Check box	<p>When this box is not checked, the chainage refers to the centreline of the alignment. The app calculates the points to be staked out from that chainage.</p> <p>When this box is checked, the chainage is calculated along chords defined for the arc. The setting is applied to the entire alignment. To stake arcs along the centreline, the check box must be unchecked.</p>  <p>a Start chainage on centreline a' Start chainage on chord b End chainage on centreline b' End chainage on chord c Chord length d Last chord at the end of an arc. May be shorter than the defined chord length.</p> <p>At the end of a first arc when starting a straight, the chainage is calculated again along the centreline until the next arc starts. At the end of the straight when starting the second arc, a new chord of the defined length is started to be used as chainage reference. At the end of an arc or for a short arc, the chord may be shorter than the defined chord length.</p>
Chord length	Editable field	Available when Calculate chainage along chord is checked. The defined chord length.

Next step

IF you work with	THEN Page changes to the
Road	Info page.
Rail	Rail design page.

**Road Settings,
Rail design page**

IF you work with	THEN Page changes to the
Tunnel	Tunnel design page.

Available for Rail only.

Description of fields

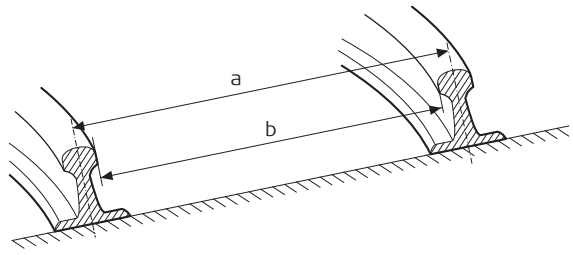
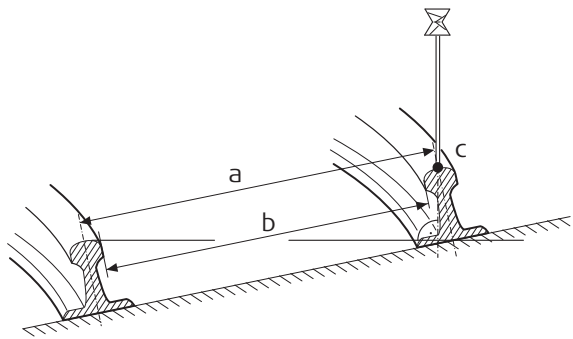
Field	Option	Description
Nominal gauge	Editable field	Nominal distance between the active (internal) faces of the left and right rails.  <p>Rail_014</p> <ul style="list-style-type: none"> a Superelevation base b Nominal gauge
Super-elevation base	Editable field	Distance over which the superelevation is to be applied. This distance normally corresponds to the distance between the rail axes.
Use super-elevation	From design Enter manually Show message	To use the superelevation values from the design. If these values don't exist in the design, then all superelevation values are ignored. To ignore all superelevation values from the design and to enter them manually. All superelevation values are ignored.
Apply target height	Plumblines	The target height is applied in plumblines to the measured position.  <p>Rail12_17</p> <ul style="list-style-type: none"> a Superelevation base b Nominal gauge c Measured point (Easting, Northing, Height)

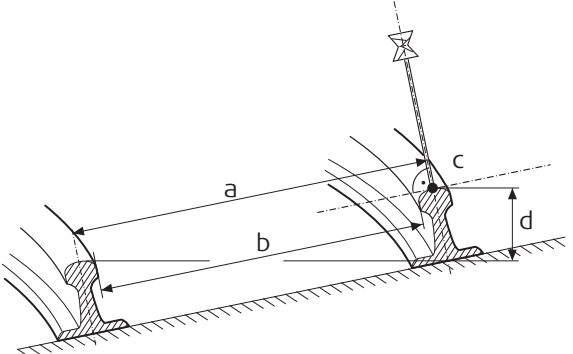
Field	Option	Description
	Perpendicular	<p>Use this setting when working with a rail bar (solar gauge) with a fix mounted prism.</p> <p>Easting, Northing and Elevation of the measured point is calculated using the design cant or, if enabled, the manually defined cant.</p>
		 <p>Rail12_18</p> <ul style="list-style-type: none"> a Superelevation base b Nominal gauge c Measured point (Easting, Northing, Height) d Superelevation
Centreline height reference	Design	The centreline height is taken from the alignment centreline.
	Interpolate from rails	The centreline height is interpolated between the left rail height and right rail height.
	Lower rail	The height of the lower rail is used as centreline height.
Always calculate chainage perpendicular to chainage centreline	Check box	<p>Chainage calculation method when checking points of multiple tracks with respect to a chainage centreline.</p> <p>The direct measurement method is when the chainage is calculated by projecting the measured point directly onto the chainage centreline.</p> <p>The indirect measurement method is when the chainage is calculated by first projecting the measured point onto the track centreline, and then projecting the point onto the chainage centreline.</p>

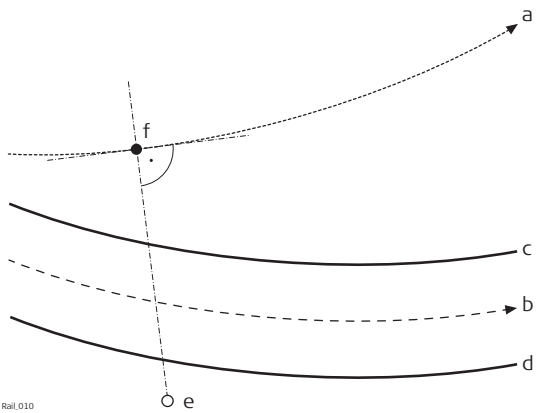
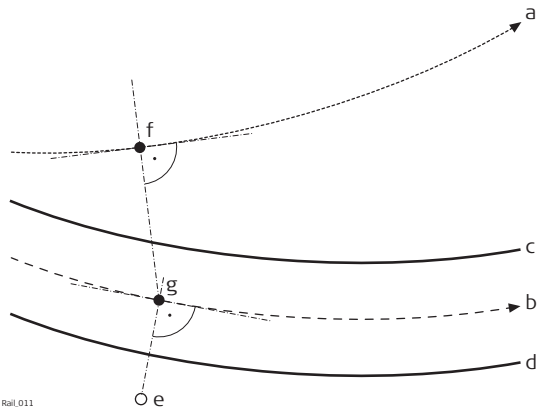
Field	Option	Description
	Checked	Project measured point directly onto the chainage centreline.
		 <p>Rail_010</p> <ul style="list-style-type: none"> a Chainage centreline b Track centreline c Left rail d Right rail e Measured point f Direct chainage
	Not checked	Project measured point onto track centreline and then make a second projection onto the chainage centreline.
		 <p>Rail_011</p> <ul style="list-style-type: none"> a Chainage centreline b Track centreline c Left rail d Right rail e Measured point f Indirect chainage g Measured point projected onto track centreline
Disable chainage centreline	Check box	Only affecting multiple track designs. The defined chainage centreline is disabled and the track centreline is used for chainage calculations.

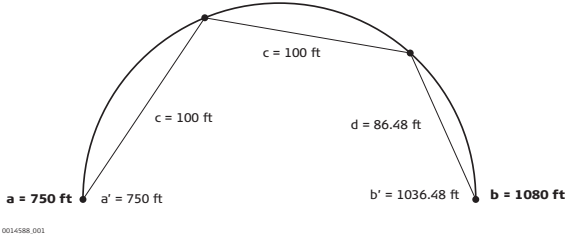
Field	Option	Description
Calculate chainage along chord	Check box	<p>When this box is not checked, the chainage refers to the centreline of the alignment. The app calculates the points to be staked out from that chainage.</p> <p>When this box is checked, the chainage is calculated along chords defined for the arc. The setting is applied to the entire alignment. To stake arcs along the centreline, the check box must be unchecked.</p>  <p>The diagram shows a circular arc with a centerline and a chord. The centerline starts at point 'a' (750 ft) and ends at point 'b' (1080 ft). The chord starts at point 'a'' (750 ft) and ends at point 'b'' (1036.48 ft). The chord length 'c' is 100 ft, and the distance from the end of the chord to the end of the arc is 'd' = 86.48 ft.</p> <p>a Start chainage on centreline a' Start chainage on chord b End chainage on centreline b' End chainage on chord c Chord length d Last chord at the end of an arc. May be shorter than the defined chord length.</p> <p>At the end of a first arc when starting a straight, the chainage is calculated again along the centreline until the next arc starts. At the end of the straight when starting the second arc, a new chord of the defined length is started to be used as chainage reference.</p> <p>At the end of an arc or for a short arc, the chord may be shorter than the defined chord length.</p>

Next step

Page changes to the **Info** page.

Rail Settings, Gauge device page

Available for Rail only.

A gauge device is used to measure the track geometry or the relative positions of the rails.

Requirements to connect to a gauge device

Configure an interface connection to be used with a device called **GAUGE DEVICE**. Create the device **GAUGE DEVICE** manually with the standard communication parameters for RS232. For example, configure a **GeoCOM** connection using **TS Bluetooth 1** with the device **GAUGE DEVICE**.

Key	Description
Adjust	Available for Gauge device: R500-FIX . To adjust the gauge device from within the software.

Description of fields

Field	Option	Description
Gauge device	Show message	No gauge device is used.
	Selectable list	Select a gauge device. The internal offsets are applied.
Gauge target offset	Editable field	Horizontal offset of the prism from the fix side of the gauge device.
Gauge target height	Editable field	Height of the prism on the gauge device.

Next step

Page changes to the **Info** page.

Road Settings, Tunnel design page

Available for Tunnel on TS only.

Description of fields

Field	Option	Description
Theoretical profile direction	Clockwise	Defines the direction in which the design profile is considered. The setting has an influence on the profile offset sign. The design profile is defined in a clockwise direction. In underbreak areas, the profile offset values are negative whereas in overbreak areas they are positive.
	Counter-clockwise	The design profile is defined in a counter-clockwise direction. In underbreak areas, the profile offset values are positive whereas in overbreak areas they are negative.
Profile definition	Vertical	Profiles are always defined as vertical.
	Tilted	Profiles are always defined perpendicular to the vertical alignment of the tunnel axis.
Scan area defined by		Available for Stake: Scan profile . When measuring tunnel profiles, it is possible to scan various profiles from one instrument position.
	Chainage	Allows a scan area to be defined by entering a back and forward chainage.
	Distance	Allow a scan area to be defined by measuring/entering a back distance and forward distance from the setup chainage.

Field	Option	Description
-------	--------	-------------

Plan view

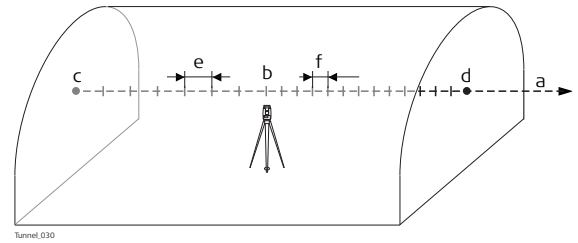

- a Alignment
- b **Instrument chainage**
- c **Start chainage** or **Start distance**
- d **End chainage** or **End distance**
- e **Before instrument**
- f **After instrument**

Drilling rig orientation	Parallel to alignment	Guides a jumbo to drill in the direction parallel to the alignment.
---------------------------------	------------------------------	---

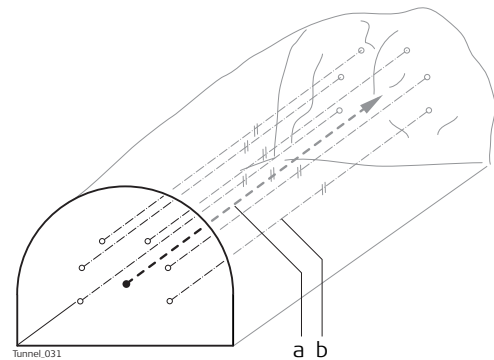

- a Alignment
- b Drill direction

Drill Pattern		Guides a jumbo to drill in the user-defined direction. The direction must not be parallel to the alignment.
----------------------	--	---

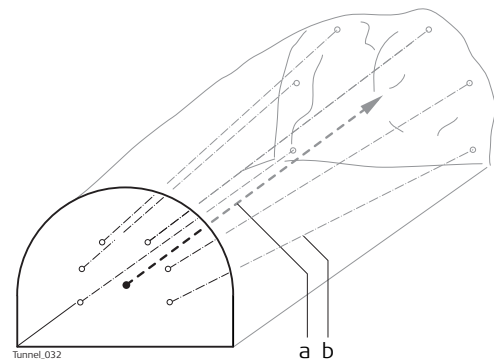

- a Alignment
- b Drill direction

Road Settings, Info page

Next step

Page changes to the **Info** page.

Two things can be configured on this page:

1. The required information for each stakeout and check method to be displayed on the **i** page. Depending on the working method used on the construction site, different information is written on the stakes. The information to be written on the stake is displayed on the **i** page.
2. If and which user-defined page is displayed.

Key	Description
OK	To confirm the changes and continue.
Clear	To clear all parameters from all lines.
Fn Default	To set the default value for all lines.
Fn About	To display information about the app name, the version number, the date of the version, the copyright and the article number.

Description of fields

Field	Option	Description
Show user defined page	Check box	The user-defined page to be shown in the stake or check panel.
Page to show	Selectable list	The names of the available pages.
Method	Display only	The method is based on the selected subapp and, if available, the setting for Stake . The settings in the following lines can only be changed for the current method. The method defines the parameters available to view on the i page of the app. Different combinations of the parameters to view can be stored
1st line to 16th line	Selectable list	To modify the selection on any particular line, place the cursor on the line to modify using the arrow keys and press the ENTER key. Use the arrow keys to select the required parameter and press the ENTER key to confirm the choice.

Field	Option	Description
		<p>Define which parameters are viewed on each line. Up to 16 lines of parameters can be defined.</p> <p>The available parameters depending on the Method selected are explained separately:</p> <ul style="list-style-type: none"> • For Road Line, refer to "43.3.2 Road Line - Info Page". • For Road Local line, refer to "43.3.3 Road Local Line - Info Page". • For Road Surface grade, refer to "43.3.4 Road Surface Grade - Info Page". • For Road Manual slope, Local manual slope and Slope, refer to "43.3.5 Road Manual Slope, Local Manual Slope and Slope - Info Page". • For Road Crown, refer to "43.3.6 Road Crown - Info Page". • For Road Layer, refer to "43.3.7 Road Layer - Info Page". • For Road DTM, refer to "43.3.8 Road DTM - Info Page". • For Rail refer to "43.3.9 Rail - Info Page". • For Tunnel refer to "43.3.10 Tunnel - Info Page - TS".

Next step



For TS: **Page** changes to the **TS specific** page.

For GS: **Page** changes to the **Report sheet** page.

Road Settings, TS specific page

Description of fields

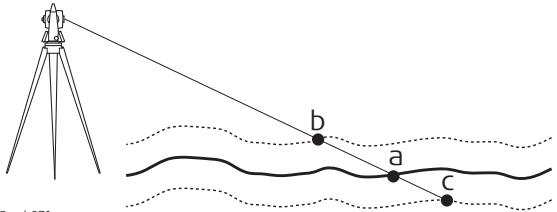
Field	Option	Description
Do not update stakeout values between distance measurements	Check box	<p>When this box is checked, angles and stake-out values are updated after a distance measurement. All values are then frozen until the next distance is taken. When Aim at target: With lock is selected and the instrument is locked onto a target the angular values do not change.</p> <p>When this box is not checked, angles are updated with telescope movement after a distance was measured.</p>

Field	Option	Description
Automatically aim instrument to point being staked	Check box	Available for Road and Rail. To make stake out of points even more efficient, a motorised instrument offers you the possibility to aim automatically at the stake-out position.
Automatic behaviour		Available for Road and Rail and when Automatically aim instrument to point being staked is checked.
	Position only	The instrument positions horizontally in the direction of the point to stake out.
	Position & height	The instrument positions horizontally and vertically to the point to stake out. The instrument only points to the correct position on the ground if the point to stake out has the same height as the natural surface. If the natural surface is higher than the point to stake out, the measured point would be closer than the stakeout point. If the natural surface is lower than the point, the measured point would be further away. With Position & measure , the possibility of iterative positioning using the auto position, this problem can be avoided.
		 <p>Road_071</p> <ul style="list-style-type: none"> a Point to stake out, defined with 3D coordinates b Position if natural surface is higher than point to stake out c Position if natural surface is lower than point to stake out
	Position & measure	Allows the instrument to aim at a 2D position. As the natural surface height is unknown the correct position is calculated via iterations.
		 Depending on the settings chosen for Red laser pointer the instrument will turn on the red laser as soon as the position is found.

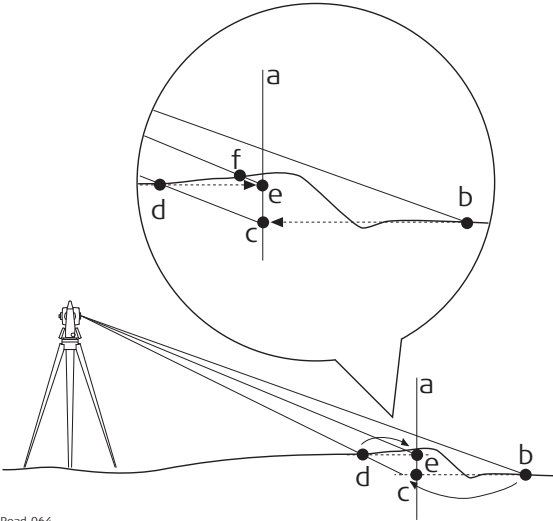

Field	Option	Description
-------	--------	-------------

The first position (b) the instrument points to is defined by the 2D coordinates (a) of the point to stake out (= horizontal direction) and the current vertical angle. Therefore, aim the instrument at the approximate position of the point to stake out. The measured 2D position is compared with the stake-out position to determine a new position (c) to aim at. As no information about the natural surface is available, a point at the same height as the measured position is calculated. The new position (d) is measured and compared again with the point to stake out (a). This iteration process runs until the tolerances defined for the stakeout are reached.

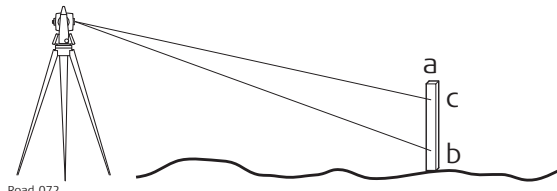

Road_064

- a 2D position to stake out
- b First position measured defined by 2D coordinates and current vertical angle
- c New position calculated based on height of b
- d Second position measured
- e New position calculated based on height of d. The measured position for this point is within the defined tolerance, the correct position is found.

Field	Option	Description
	Prompt before turn	<p>The method how the instrument turns is not fixed but is selected when pressing Position. Additionally to the three methods listed above, an option allowing the instrument to find the height on the peg is available:</p>  <p style="text-align: center; font-size: small;">Road_072</p> <ul style="list-style-type: none"> a Peg placed at the correct position b First height, manually chosen direction c Required height on the peg <p>For more information refer to "43.3.11 Work-flow for Height (aim to stake ht) - for TS".</p>
Position limit	From 0.001 to 10	<p>Maximum permitted radial horizontal distance. Available for Tunnel and for Road/Rail with Automatic behaviour: Position & measure or Automatic behaviour: Prompt before turn.</p>
Height limit	From 0.001 to 10	<p>Maximum height difference. Available for Road and Rail.</p>
Chainage limit	From 0.001 to 10	<p>Chainage tolerance of the position to stake out. Available for Tunnel and for Road/Rail with Automatic behaviour: Position & measure or Automatic behaviour: Prompt before turn.</p>
Offset limit	From 0.001 to 10	<p>Maximum horizontal offset from defined position. Available for Road and Rail.</p>
Red laser pointer		<p>Defines when the visible red laser beam is turned on during the automatic search of the position. Available for Tunnel and for Road/Rail with Automatic behaviour: Position & measure or Automatic behaviour: Prompt before turn.</p>
	Always off	<p>Visible red laser is turned off.</p>
	Turn on when aimed at pt	<p>Visible red laser is turned on as soon as the point is found.</p>
	Always on	<p>Visible red laser is turned on during the whole search.</p>
		<p> The laser can also be permanently turned on by using the instrument settings. Refer to "22.5 Lights & accessories" for more information.</p>

Field	Option	Description
Maximum iterations	From 2 to 10	Maximum number of iterations for the distance measurement before stopping. Available for Tunnel and for Road/Rail with Automatic behaviour: Position & measure or Automatic behaviour: Prompt before turn .

Next step

Page changes to the **Report sheet** page. Refer to "36 Apps - General".

43.3.2

Road Line - Info Page

Description

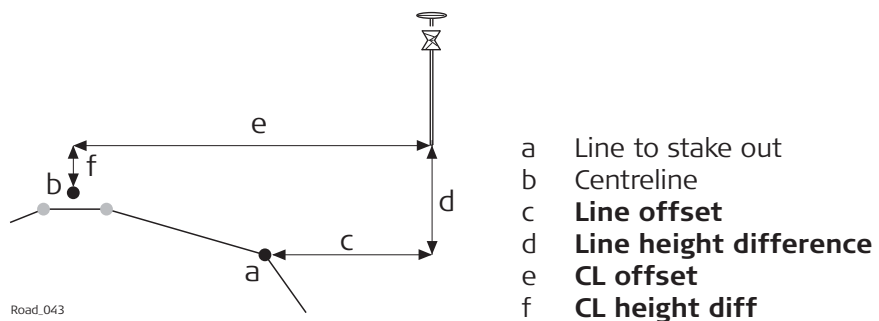

This  page is used for staking and checking Road lines.

Available fields



The following parameters are available. All fields are display only.

Field	Description
Line task	Name defined for the line task.
Difference in offset	Horizontal offset between the defined position and the current position.
Difference in height	Vertical offset between the defined position and the current position.
Difference in chainage	Difference between the defined chainage and the current chainage.
	 If no defined chainage exists, for example if staking out random chainages or checking, this field reads Difference in chainage: ----- .
Chainage	The current chainage. This field is independent of the chosen settings for Help me navigate and Navigational arrow types in Road Settings, Graphics page.
Stake chainage	Chainage to stake out.
Line offset	Horizontal offset from the line.
Line height difference	Height difference from the defined line.
Line name	Name of the line to stake out or the stakeout is relative to.

Field	Description
Additional line	The name of an extra line.
Additional line chainage	Current local chainage of extra line.
Additional line offset	Current perpendicular offset to the additional line including the defined stake/check offset of extra line of the  page.
Additional line ht diff	Current height difference to the additional line including the defined stake/check height difference of the additional line of  page.
CL height diff	Height difference from the centreline.
CL height	Height of the centreline at the current chainage.
CL radius	Radius of the centreline at the current chainage.
CL type	Element type of the centreline.
CL offset	Perpendicular horizontal offset from the centreline. This field is independent of the chosen settings for Help me navigate and Navigational arrow types in Road Settings, Graphics page.
CL tangent	Tangent direction of the centreline at the current chainage.
Offset angle	The current angle to selected line.
Nearest hz tangent point	The chainage difference between the measured point and the nearest tangent point of the design is displayed. The nearest tangent point is the start/end point of a road segment.

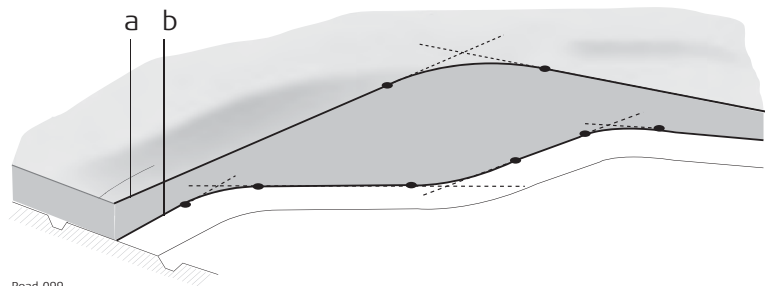





Road_099

- a Vertical alignment
- b Horizontal alignment

Only tangent points are detected. A tangent point is the start/end point of a road segment.

Nearest vertical tangent point	Distance to the nearest vertical tangent point of the design.
Height difference at 3D chainage	Offset perpendicular to the vertical component of the selected line. This value can be useful when dealing with pipelines, cables and in the construction segment.
3D chainage	Chainage of the measured point is projected perpendicular to the vertical component of the selected line.

Field	Description
	<p>Road_089</p> <ul style="list-style-type: none"> a 3D chainage b Chainage c Centreline d Centreline height difference e Height difference at 3D chainage
Centreline grade	Grade of the centreline at the current position.
Direction to point	Direction from the current position to the point to stake out.
Distance to point	Distance from the current position to the point to stake out.
Defined easting	Easting of the point to stake out.
Defined northing	Northing of the point to stake out.
Defined height	Height of the point to stake out.
Current design east	Easting of the design for the current position. A relevant point at the selected line.
Current design north	Northing of the design for the current position. A relevant point at the selected line.
Current design height	Height of the design for the current position. A relevant point at the selected line.
Actual easting	Easting of the current position.
Actual northing	Northing of the current position.
Actual height	Height of the current position.
3D quality	Standard deviation of the point measurement.

Field	Description
Go forward/backward	Distance to point. Available for staking. For Navigational arrow types: In/out, left/right in 3D viewer equivalent to:
	
Go left/right	Distance to point. Available for staking. For Navigational arrow types: In/out, left/right in 3D viewer equivalent to:
	
Go	Distance to point. Available for staking. For Navigational arrow types: Direction & distance in 3D viewer equivalent to:
	
Turn left/right	Direction to point. Available for staking. For Navigational arrow types: Direction & distance in 3D viewer equivalent to:
	
Separator and Unused line	Empty line.

43.3.3

Road Local Line - Info Page

Available fields

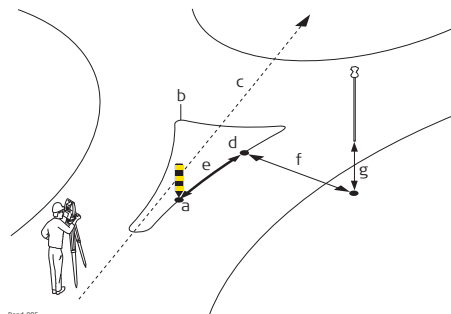



Stakeout of roundabout

- a Position to stake out
- b Line to stake out
- c Centreline
- d **Chainage**
- e **Difference in chainage**
- f **Difference in offset**
- g **Difference in height**

The following parameters are available. All fields are display only.

Field	Description
Line task	Name defined for the local line task.

Field	Description
Additional line	The name of an extra line.
Additional line chainage	Current local chainage of extra line.
Additional line offset	Current perpendicular offset to the additional line including the defined stake/check offset of extra line of the  page.
Additional line ht diff	Current height difference to the additional line including the defined stake/check height difference of the additional line of  page.
Difference in offset	Horizontal offset between the defined position and the current position.
Difference in height	Vertical offset between the defined position and the current position.
Difference in chainage	Difference between the defined chainage and the current chainage.
	 If no defined chainage exists, for example if staking out random chainages or checking, this field reads Difference in chainage: ----- .
Chainage	The current chainage. This field is independent of the chosen settings for Help me navigate and Navigational arrow types in Road Settings, Graphics page.
Stake chainage	Chainage to stake out.
Line offset	Horizontal offset from the line.
Line height difference	Height difference from the defined line.
Line name	Name of the line to stake out or the stakeout is relative to.
CL height diff	Height difference from the centreline.
CL height	Height of the centreline at the current chainage.
CL radius	Radius of the centreline at the current chainage.
CL type	Element type of the centreline.
CL offset	Perpendicular horizontal offset from the centreline. This field is independent of the chosen settings for Help me navigate and Navigational arrow types in Road Settings, Graphics page.
CL tangent	Tangent direction of the centreline at the current chainage.
Offset angle	The current angle to selected line.
Nearest hz tangent point	The chainage difference between the measured point and the nearest tangent point of the design is displayed. The nearest tangent point is the start/end point of a road segment.

Field	Description
-------	-------------

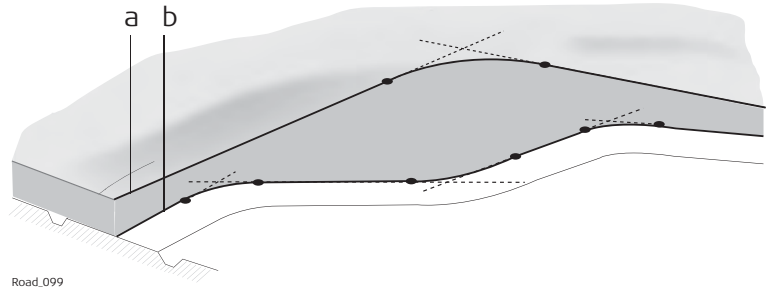

Road_099

- a Vertical alignment
- b Horizontal alignment

Only tangent points are detected. A tangent point is the start/end point of a road segment.

Nearest vertical tangent point	Distance to the nearest vertical tangent point of the design.
---------------------------------------	---

Height difference at 3D chainage	Offset perpendicular to the vertical component of the selected line. This value can be useful when dealing with pipelines, cables and in the construction segment.
---	---

3D chainage	Chainage of the measured point is projected perpendicular to the vertical component of the selected line.
--------------------	---

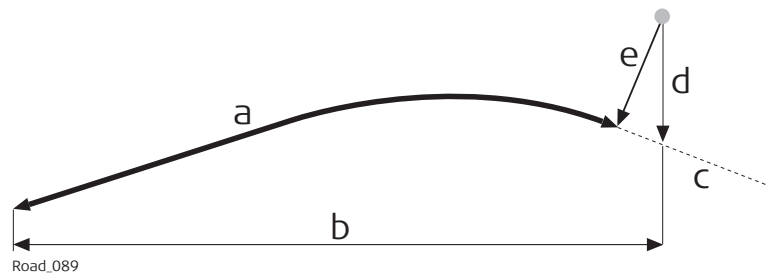

Road_089

- a **3D chainage**
- b Chainage
- c Centreline
- d Centreline height difference
- e **Height difference at 3D chainage**

Centreline grade	Grade of the centreline at the current position.
-------------------------	--



Direction to point	Direction from the current position to the point to stake out.
---------------------------	--

Distance to point	Distance from the current position to the point to stake out.
--------------------------	---

Defined easting	Easting of the point to stake out.
------------------------	------------------------------------

Defined northing	Northing of the point to stake out.
-------------------------	-------------------------------------

Defined height	Height of the point to stake out.
-----------------------	-----------------------------------

Field	Description
Actual easting	Easting of the current position.
Actual northing	Northing of the current position.
Actual height	Height of the current position.
Current design east	Easting of the design for the current position. Relevant point at the line.
Current design north	Northing of the design for the current position. Relevant point at the line.
Current design height	Height of the design for the current position. Relevant point at the line.
Height at end of vertical alignment	Height at the endpoint of the vertical alignment of the line.
Difference in height at end of vertical alignment	Height difference to the endpoint of the vertical alignment of the line.
3D quality	Standard deviation of the point measurement.
Go forward/backward	Distance to point. Available for staking. For Navigational arrow types: In/out, left/right in 3D viewer equivalent to: 
Go left/right	Distance to point. Available for staking. For Navigational arrow types: In/out, left/right in 3D viewer equivalent to: 
Go	Distance to point. Available for staking. For Navigational arrow types: Direction & distance in 3D viewer equivalent to: 

Field	Description
Turn left/ right	Direction to point. Available for staking. For Navigational arrow types: Direction & distance in 3D viewer equivalent to:
	
Separator and Unused line	Empty line.

Working with pipe-lines

Description

When staking/checking pipes, a common task is to use height differences at the start/end of the pipe. The two **i** page items for local lines enable the height difference to be added to the end of the vertical alignments **Difference in height at end of vertical alignment** and **Height at end of vertical alignment**.

43.3.4

Road Surface Grade - Info Page

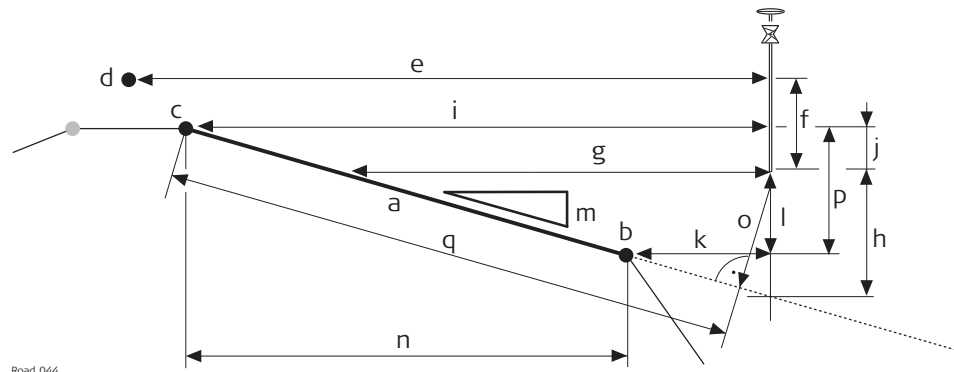

Available fields



Road_044

- a Surface grade to stake out
- b Right line of the surface grade **Right name**
- c Left line of the surface grade **Left name**
- d Centreline
- e **CL offset**
- f **CL height diff**
- g **Surface grade offset**
- h **Surface grade ht diff**
- i **Left offset**
- j **Left height diff**
- k **Right offset**
- l **Right height diff**
- m **Surface grade ratio**
- n **Width**
- o **Square offset**
- p **Camber** (in this case negative)
- q **Square slope dist**

The following parameters are available. All fields are display only.

Field	Description
Surface grade task	Name defined for the surface grade task.
Additional line	The name of an extra line.
Additional line chainage	Current local chainage of extra line.
Additional line offset	Current perpendicular offset to the additional line including the defined stake/check offset of extra line of the  page.
Additional line ht diff	Current height difference to the additional line including the defined stake/check height difference of the additional line of  page.
Difference in offset	Horizontal offset between the defined position and the current position.
Difference in height	Vertical offset between the defined position and the current position.
Difference in chainage	Difference between the defined chainage and the current chainage.  If no defined chainage exists, for example if staking out random chainages or checking, this field reads Difference in chainage: ----- .
Chainage	The current chainage. This field is independent of the chosen settings for Help me navigate and Navigational arrow types in Road Settings, Graphics page.
Stake chainage	Chainage to stake out.
Surface grade offset	Horizontal offset from the surface grade.
Surface grade ht diff	Height difference to the surface grade. If no stake height difference is used Surface grade ht diff = Difference in height .
Camber	The superelevation of the active surface grade. The calculation is always in relation to the defined reference line of the surface grade: Camber = line – reference line
Left name	Name of the left line defining the surface grade.
Left offset	Horizontal offset from the left point of the surface grade.
Left height diff	Height difference from the left point of the surface grade.
Right name	Name of the right line defining the surface grade.
Right offset	Horizontal offset from the right point of the surface grade.
Right height diff	Height difference from the right point of the surface grade.
Ref line	Indicates which side of the surface grade the stakeout is relative to.

Field	Description
Ref offset	Horizontal offset from the line of the surface grade used as reference. Depends on Ref line and is identical to Right offset or Left offset .
Ref height diff	Height difference from the line of the surface grade used as reference. Depends on Ref line and is identical to Right height diff or Left height diff .
Surface grade ratio	Slope ratio of the surface grade.
Square offset	Offset from the surface grade, perpendicular to the surface grade.
Square slope dist	Slope distance from the slope reference line to the current position perpendicular to the slope. The slope distance is always at the same grade as the defined or current slope. If the current position is above or below the slope, the slope distance is projected square to the slope. The slope distance is calculated to the defined reference point. The Square slope dist is measured from the current position to the reference line.
CL height diff	Height difference from the centreline.
CL height	Height of the centreline at the current chainage.
CL radius	Radius of the centreline at the current chainage.
CL type	Element type of the centreline.
CL offset	Perpendicular horizontal offset from the centreline. This field is independent of the chosen settings for Help me navigate and Navigational arrow types in Road Settings, Graphics page.
CL tangent	Tangent direction of the centreline at the current chainage.
Width	Horizontal width of the surface grade.
Nearest hz tangent point	The chainage difference between the measured point and the nearest tangent point of the design is displayed. The nearest tangent point is the start/end point of a road segment.

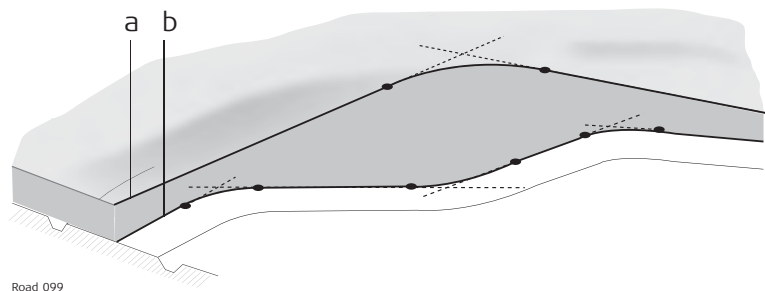

- a Vertical alignment
- b Horizontal alignment



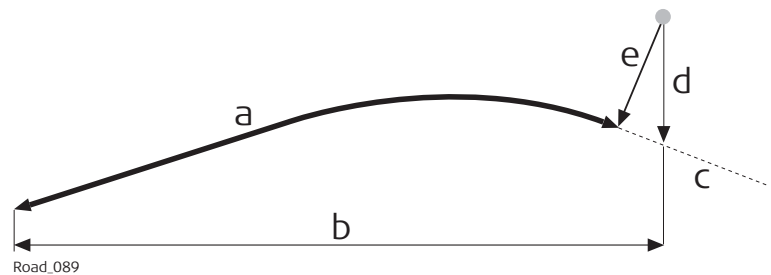

Only tangent points are detected. A tangent point is the start/end point of a road segment.

Field	Description
Nearest vertical tangent point	Distance to the nearest vertical tangent point of the design.
Centreline grade	Grade of the centreline at the current position.
Height difference at 3D chainage	Offset perpendicular to the vertical component of the selected line. This value can be useful when dealing with pipelines, cables and in the construction segment.
3D chainage	Chainage of the measured point is projected perpendicular to the vertical component of the selected line.



- a **3D chainage**
- b Chainage
- c Centreline
- d Centreline height difference
- e **Height difference at 3D chainage**

Direction to point	Direction from the current position to the point to stake out.
Distance to point	Distance from the current position to the point to stake out.
Defined easting	Easting of the point to stake out.
Defined northing	Northing of the point to stake out.
Defined height	Height of the point to stake out.
Actual easting	Easting of the current position.
Actual northing	Northing of the current position.
Actual height	Height of the current position.
Current design east	Easting of the design for the current position. Relevant point on the surface grade = Actual easting .
Current design north	Northing of the design for the current position. Relevant point on the surface grade = Actual northing .

Field	Description
Current design height	Height of the design for the current position. Relevant point on the surface grade.
3D quality	Standard deviation of the point measurement.
Go forward/backward	Distance to point. Available for staking. For Navigational arrow types: In/out, left/right in 3D viewer equivalent to: 
Go left/right	Distance to point. Available for staking. For Navigational arrow types: In/out, left/right in 3D viewer equivalent to: 
Go	Distance to point. Available for staking. For Navigational arrow types: Direction & distance in 3D viewer equivalent to: 
Turn left/right	Direction to point. Available for staking. For Navigational arrow types: Direction & distance in 3D viewer equivalent to: 
Separator and Unused line	Empty line.

Available fields

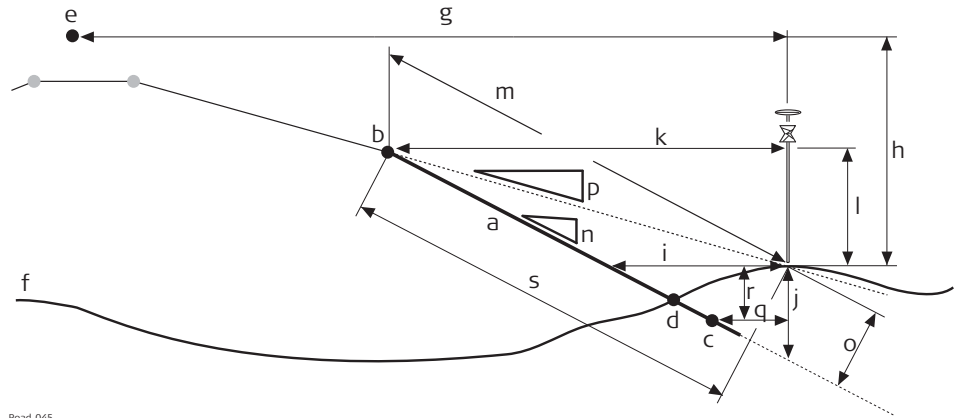



Road_045

- a Slope to stake out/check
- b Hinge point **Hinge name**, reference line
- c Second line of slope **Additional line name**
- d Real catch point
- e Centreline
- f Natural surface
- g **CL offset**
- h **CL height diff**
- i **Slope offset**
- j **Slope height diff**
- k **Hinge offset**
- l **Hinge ht diff**
- m **Slope distance hinge**
- n **Slope design ratio**
- o **Square offset**
- p **Current slope ratio**
- q **Additional line offset**
- r **Additional line ht diff**
- s **Square slope dist**

The following parameters are available. All fields are display only.

Field	Description
Slope task	Name defined for the slope task.
Difference in offset	Horizontal offset between the defined position and the current position.
Difference in height	Vertical offset between the defined position and the current position.
Difference in chainage	Difference between the defined chainage and the current chainage.
	 If no defined chainage exists, for example if staking out random chainages or checking, this field reads Difference in chainage: ----- .
Chainage	The current chainage. This field is independent of the chosen settings for Help me navigate and Navigational arrow types in Road Settings, Graphics page.

Field	Description
Stake chainage	Chainage to stake out.
Slope offset	Horizontal offset from the slope.
Slope height diff	Height difference from the slope. If no stake height difference is used Slope height diff = Difference in height .
Height difference rail	Height difference from the batter rail to mark the slope (for Type: Batter rail vertical in Slope Stakeout Settings).
Hinge name	Name of the line defining the hinge of the slope.
Hinge offset	Horizontal offset from the hinge point of the slope.
Hinge ht diff	Height difference from the hinge point of the slope.
Additional line name	Name of the second line defining the slope.
Additional line offset	Horizontal offset from the second line of the slope.
Additional line ht diff	Height difference from the second line of the slope.
Slope design ratio	Ratio of the slope.  The display format is defined as system setting in Regional, Slope page.
Slope distance hinge	Slope distance to the hinge point.  All defined settings for a batter rail or reference point are already taken into account. This value is the information to write on the stake.
Slope design ratio (gon)	Slope ratio in gon.
Slope design ratio (deg)	Slope ratio in decimal degrees.
Slope design ratio (%)	Slope ratio in percent.
Current slope ratio	Ratio of the slope from the current position to the hinge.  For the catch point, the Current slope ratio is identical to the Slope design ratio .
Square offset	Offset from the slope, perpendicular to the slope.

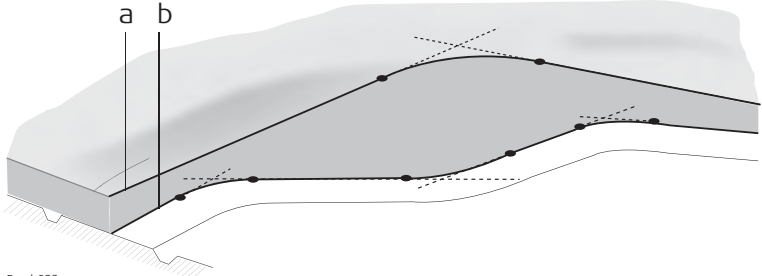

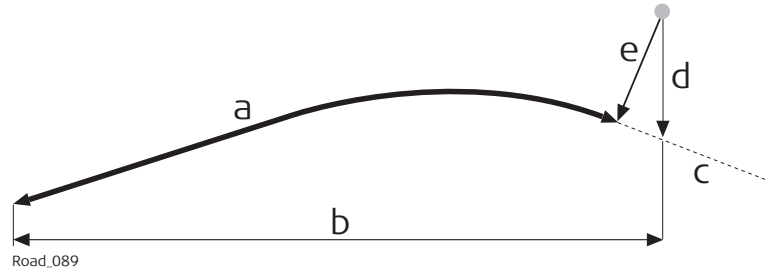

Field	Description
Square slope dist	<p>Slope distance from the slope reference line to the current position perpendicular to the slope. The slope distance is always at the same grade as the defined or current slope. If the current position is above or below the slope, the slope distance is projected square to the slope. The slope distance is calculated to the defined reference point.</p> <p>For slope, the Square slope dist is measured from the current position to the reference line.</p> <p>For manual slope and local manual slope, Square slope dist is measured from the current position to the hinge line.</p>
CL height diff	Height difference from the centreline.
CL height	Height of the centreline at the current chainage.
CL radius	Radius of the centreline at the current chainage.
CL type	Element type of the centreline.
CL offset	Perpendicular horizontal offset from the centreline. This field is independent of the chosen settings for Help me navigate and Navigational arrow types in Road Settings, Graphics page.
CL tangent	Tangent direction of the centreline at the current chainage.
Offset angle	Available for manual slope. The defined value for the angle to alignment.
Traveller height	<p>Height of the traveller in use.</p> <p>Refer to "45.2.3 Advanced Slope Settings" for information on the different methods of slope staking.</p>
Nearest hz tangent point	<p>The chainage difference between the measured point and the nearest tangent point of the design is displayed. The nearest tangent point is the start/end point of a road segment.</p> <div style="text-align: center;">  <p>Road_099</p> <p>a Vertical alignment b Horizontal alignment</p> <p>Only tangent points are detected. A tangent point is the start/end point of a road segment.</p> </div>
Nearest vertical tangent point	Distance to the nearest vertical tangent point of the design.

Field	Description
Height difference at 3D chainage	Offset perpendicular to the vertical component of the selected line. This value can be useful when dealing with pipelines, cables and in the construction segment.
3D chainage	Chainage of the measured point is projected perpendicular to the vertical component of the selected line.



- a **3D chainage**
- b Chainage
- c Centreline
- d Centreline height difference
- e **Height difference at 3D chainage**

Centreline grade	Grade of the centreline at the current position.
Direction to point	Direction from the current position to the point to stake out.
Distance to point	Distance from the current position to the point to stake out.
Defined easting	Easting of the point to stake out.
Defined northing	Northing of the point to stake out.
Defined height	Height of the point to stake out.
Actual easting	Easting of the current position.
Actual northing	Northing of the current position.
Actual height	Height of the current position.
Current design east	Easting of the design for the current position. Relevant point on the slope = Actual easting .
Current design north	Northing of the design for the current position relevant point on the slope = Actual northing .
Current design height	Height of the design for the current position. Relevant point on the slope.
3D quality	Standard deviation of the point measurement.

Field	Description
Go forward/ backward	Distance to point. Available for staking. For Navigational arrow types: In/out, left/right in 3D viewer equivalent to:
	
Go left/right	Distance to point. Available for staking. For Navigational arrow types: In/out, left/right in 3D viewer equivalent to:
	
Go	Distance to point. Available for staking. For Navigational arrow types: Direction & distance in 3D viewer equivalent to:
	
Turn left/ right	Direction to point. Available for staking. For Navigational arrow types: Direction & distance in 3D viewer equivalent to:
	
Separator and Unused line	Empty line.

43.3.6

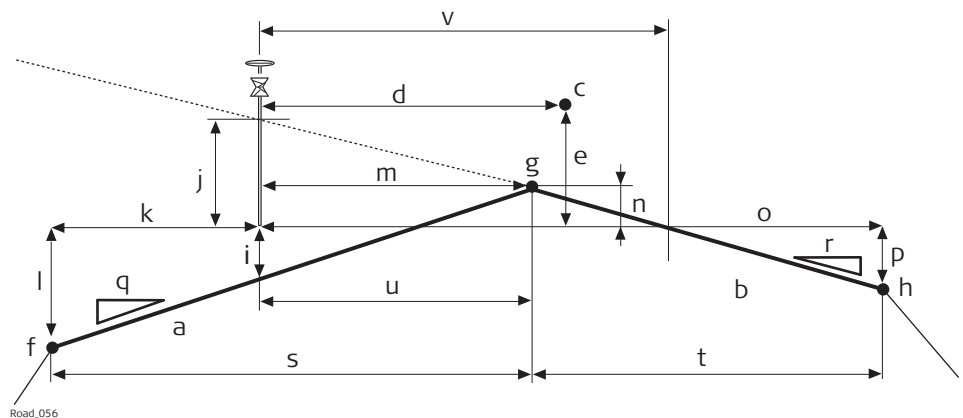

Road Crown - Info Page

Available fields







- a Left surface grade of road crown
- b Right surface grade of road crown
- c Centreline
- d **CL offset**
- e **CL height diff**
- f Left most line of the crown **Left name**
- g Middle line of the crown **Mid name**
- h Right most line of the crown **Right name**
- i **Left surface grade ht diff**
- j **Right surface grade ht diff**
- k **Left offset**
- l **Left height diff**
- m **Mid offset**
- n **Mid height diff**
- o **Right offset**
- p **Right height diff**
- q **L surf. grade ratio**
- r **Right surface grade ratio**
- s **Left width**
- t **Right width**

The following parameters are available. All fields are display only.

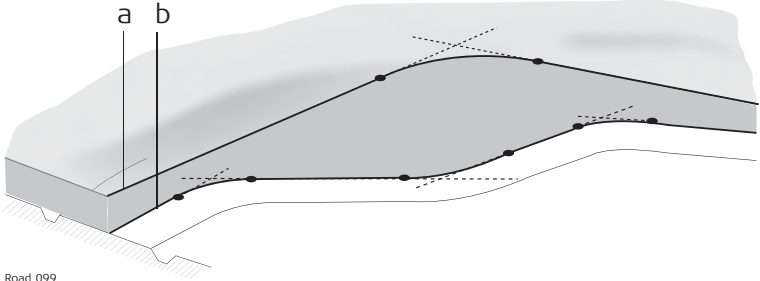
Field	Description
Crown task	Name defined for the road crown task.
Additional line	The name of an extra line.
Additional line chainage	Current local chainage of extra line.
Additional line offset	Current perpendicular offset to the additional line including the defined stake/check offset of extra line of the  page.
Additional line ht diff	Current height difference to the additional line including the defined stake/check height difference of the additional line of  page.
Difference in offset	Horizontal offset to the line of the crown defined as the reference line. If working in the toggle offset left/right mode, the correct line is automatically selected as the reference. The measured point can be to the left or right of the middle line. Refer to "45.3.8 Measuring Road Crowns" for more information on the toggle offset left/right mode.
Difference in height to left cross slope	Vertical offset to the left/right surface grade defining the road crown.
Diff in ht to right surface	Vertical offset to the left/right surface grade defining the road crown.
Difference in chainage	Difference between the defined chainage and the current chainage.

Field	Description
	 If no defined chainage exists, for example if staking out random chainages or checking, this field reads Difference in chainage: ----- .
Chainage	The current chainage. This field is independent of the chosen settings for Help me navigate and Navigational arrow types in Road Settings, Graphics page.
Stake chainage	Chainage to stake out.
Left surface grade ht diff	Height difference from the road crowns left surface grade.
Right surface grade ht diff	Height difference from the road crowns right surface grade.
Height difference crown	Height difference from Active surface grade of the crown.
Active surface grade	Indicates if you are on the left or right surface grade of the road crown.
Active surface grade ratio	Slope ratio of Active surface grade . This value is equal to L surf. grade ratio or Right surface grade ratio depending on the value of Active surface grade .
Left name	Name of the left-most line defining the road crown.
Left offset	Horizontal offset from the left line of the road crown.
Left height diff	Height difference from the left line of the road crown.
Right name	Name of the left-most line defining the road crown.
Right offset	Horizontal offset from the right line of the road crown.
Right height diff	Height difference from the right line of the road crown.
Mid name	Name of the mid line defining the road crown.
Mid offset	Horizontal offset from the mid line of the road crown.
Mid height diff	Height difference from the mid line of the road crown.
L surf. grade ratio	Slope ratio of the road crowns left surface grade.
Right surface grade ratio	Slope ratio of the road crowns right surface grade.
Left width	Horizontal width of the road crowns left surface grade.
Right width	Horizontal width of the road crowns right surface grade.
CL height diff	Height difference from the centreline.
CL height	Height of the centreline at the current chainage.
CL radius	Radius of the centreline at the current chainage.

Field	Description
CL type	Curve type of the centreline.
CL offset	Perpendicular horizontal offset from the centreline. This field is independent of the chosen settings for Help me navigate and Navigational arrow types in Road Settings, Graphics page.
CL tangent	Tangent direction of the centreline at the current chainage.
Nearest hz tangent point	The chainage difference between the measured point and the nearest tangent point of the design is displayed. The nearest tangent point is the start/end point of a road segment.
 <p style="text-align: center;">Road_099</p> <p style="text-align: center;">a Vertical alignment b Horizontal alignment</p> <p style="text-align: center;">Only tangent points are detected. The tangent point is the start/end point of a road segment.</p>	
Nearest vertical tangent point	Distance to the nearest vertical tangent point of the design.
Centreline grade	Grade of the centreline at the current position.
Direction to point	Direction from the current position to the point to stake out.
Distance to point	Distance from the current position to the point to stake out.
Defined easting	Easting of the point to stake out.
Defined northing	Northing of the point to stake out.
Defined height	Height of the point to stake out.
Actual easting	Easting of the current position.
Actual northing	Northing of the current position.
Actual height	Height of the current position.
Current design east	Easting of the design for the current position (relevant point on the crown = Actual easting).

Field	Description
Current design north	Northing of the design for the current position relevant point on the crown = Actual northing).
Current design height	Height of the design for the current position. Relevant point on the crown.
3D quality	Standard deviation of the point measurement.
Go forward/backward	Distance to point. Available for staking. For Navigational arrow types: In/out, left/right in 3D viewer equivalent to: 
Go left/right	Distance to point. Available for staking. For Navigational arrow types: In/out, left/right in 3D viewer equivalent to: 
Go	Distance to point. Available for staking. For Navigational arrow types: Direction & distance in 3D viewer equivalent to: 
Turn left/right	Direction to point. Available for staking. For Navigational arrow types: Direction & distance in 3D viewer equivalent to: 
Separator and Unused line	Empty line.

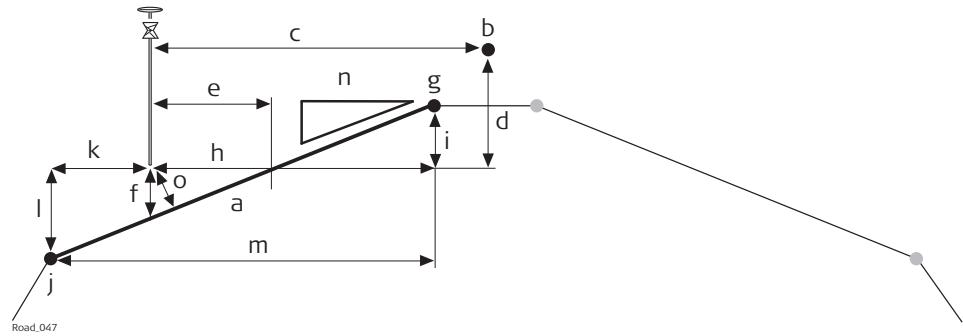

Available fields



- a Relevant part of the layer
- b Centreline
- c **CL offset**
- d **CL height diff**
- e Slope offset
- f **Layer ht diff**
- g **Right name**
- h **Right offset**
- i **Right height diff**
- j **Left name**
- k **Left offset**
- l **Left height diff**
- m **Width**
- n **Slope design ratio** or **Surface grade ratio**
- o **Square offset**

The following parameters are available. All fields are display only.

Field	Description
Layer task	Name defined for the layer task.
Layer name	Name of the layer to check.
Chainage	Chainage of the current measured position.
Difference in chainage	Difference between the defined chainage and the current chainage. ☞ If no defined chainage exists, for example if staking out random chainages or checking, this field reads Difference in chainage: ----- .
Stake chainage	Chainage to stake out.
Layer offset	Horizontal offset from the layer. Surface between Left line and Right line .
Layer ht diff	Height difference of the measured position to the layer
Difference in height	Height difference to the layer, including the stake or check height difference.
Left name	Name of the line next to the current position on the left side.
Left offset	Horizontal offset from the left line Left name .

Field	Description
Layer ht diff	Height difference to the left line Left name .
Right name	Name of the line next to the current position on the right side.
Right offset	Horizontal offset from the right line Right name .
Right height diff	Height difference to the right line Right name .
Slope design ratio	Ratio of the slope between the left line Left name and the right line Right name .  The display format is defined as system setting in Regional, Slope page.
Surface grade ratio	Ratio of the surface grade between the left line Left name and the right line Right name .  The display format of the Surface grade ratio depends on the type chosen for Surface grade on Regional, Slope page.
Square off-set	Offset from the slope, perpendicular to the slope.
CL height diff	Height difference from the centreline.
CL height	Height of the centreline at the current chainage.
CL radius	Radius of the centreline at the current chainage.
CL type	Curve type of the centreline.
CL offset	Horizontal offset from the centreline at the current chainage.
CL tangent	Tangent direction of the centreline at the current chainage.
Traveller height	The height of the traveller.
Nearest hz tangent point	The chainage difference between the measured point and the nearest tangent point of the design is displayed. The nearest tangent point is the start/end point of a road segment.

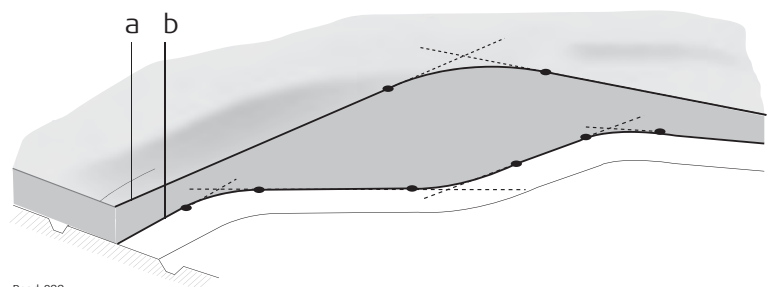





- a Vertical alignment
b Horizontal alignment

Only tangent points are detected. The tangent point is the start/end point of a road segment.

Field	Description
Nearest vertical tangent point	Distance to the nearest vertical tangent point of the design.
Height difference at 3D chainage	Offset perpendicular to the vertical component of the selected line. This value can be useful when dealing with pipelines, cables and in the construction segment.
3D chainage	Chainage of the measured point is projected perpendicular to the vertical component of the selected line.

a	3D chainage
b	Chainage
c	Centreline
d	Centreline height difference
e	Height difference at 3D chainage

Centreline grade	Grade of the centreline at the current position.
Direction to point	Direction from the current position to the point to stake out.
Distance to point	Distance from the current position to the point to stake out.
Defined easting	Easting of the point to stake out.
Defined northing	Northing of the point to stake out.
Defined height	Height of the point to stake out.
Actual easting	Easting of the current position.
Actual northing	Northing of the current position.
Actual height	Height of the current position.
Current design east	Easting of the design for the current position (relevant point on the crown = Actual easting).
Current design north	Northing of the design for the current position relevant point on the crown = Actual northing).

Field	Description
Current design height	Height of the design for the current position. Relevant point on the crown.
3D quality	Standard deviation of the point measurement.
Go forward/backward	Distance to point. Available for staking. For Navigational arrow types: In/out, left/right in 3D viewer equivalent to: 
Go left/right	Distance to point. Available for staking. For Navigational arrow types: In/out, left/right in 3D viewer equivalent to: 
Go	Distance to point. Available for staking. For Navigational arrow types: Direction & distance in 3D viewer equivalent to: 
Turn left/right	Direction to point. Available for staking. For Navigational arrow types: Direction & distance in 3D viewer equivalent to: 
Separator and Unused line	Empty line.

43.3.8

Road DTM - Info Page



An **i** page is only available for **Check rail**.

Available fields

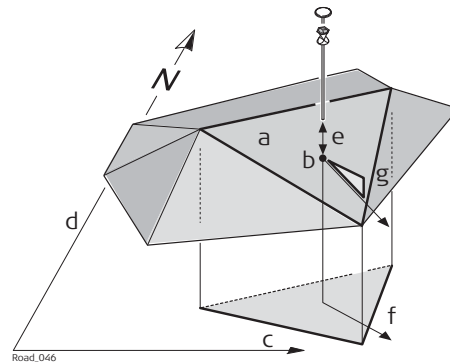

- a Relevant triangle of the DTM
- b Projected point on DTM
- c Easting
- d Northing
- e **DTM height diff**
- f **Flow direction**
- g **Flow ratio**

The following parameters are available. All fields are display only.

Field	Description
DTM task	Name defined for the DTM task.
DTM height diff	Vertical height difference to the DTM.
Difference in height	Height difference to the layer including the stake or check height difference.
DTM height	Height of the DTM at the current measured position.
Flow direction	Direction of maximum slope ratio on the current DTM triangle. This direction is the direction water would flow toward from the projected point.
Flow ratio	Slope ratio of the DTM. This ratio is the maximum slope ratio of the triangle.
DTM name	Name of the DTM surface.
Actual easting	Easting of the current position.
Actual northing	Northing of the current position.
Actual height	Height of the current position.
Current design east	Easting of the DTM for the current position = Actual easting .
Current design north	Northing of the DTM for the current position = Actual northing .
Current design height	Height of the DTM for the current position.
3D quality	Standard deviation of the point measurement.
Separator and Unused line	Empty line.

Available fields

The following parameters are available. All fields are display only.



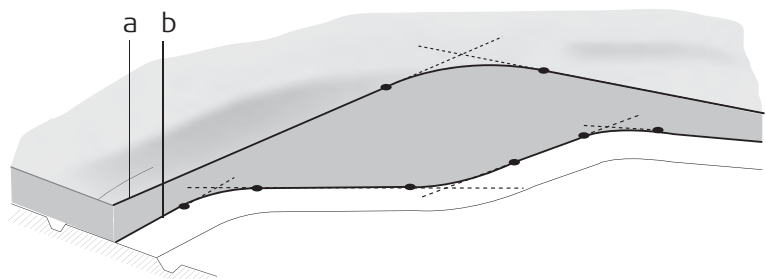

Field	Description
Difference in offset	Distance from the measured point to the point to stake out in a direction perpendicular to the horizontal alignment.
Difference in height	Vertical offset between the defined position and the current position.
Difference in chainage	Difference between the defined chainage and the current chainage.  If no defined chainage exists, for example if staking out random chainages or checking, this field reads Difference in chainage: ----- .
Chainage	The current chainage. This field is independent of the chosen settings for Help me navigate and Navigational arrow types in Road Settings, Graphics page.
CL height diff	Height difference from the centreline.
CL height	Height of the centreline at the current chainage.
CL radius	Radius of the horizontal alignment at the chainage of the measured point.
CL type	Element type of the centreline.
CL offset	Perpendicular horizontal offset from the centreline. This field is independent of the chosen settings for Help me navigate and Navigational arrow types in Road Settings, Graphics page.
CL tangent	Tangent direction of the centreline at the current chainage.
Nearest hz tangent point	The chainage difference between the measured point and the nearest tangent point of the design is displayed. The nearest tangent point is the start/end point of a road segment.
Nearest vertical tangent point	Distance to the nearest vertical tangent point of the design.



- a Vertical alignment
- b Horizontal alignment

Only tangent points are detected. The tangent point is the start/end point of a road segment.

Field	Description
Centreline grade	Grade of the centreline at the current position.
Direction to point	Direction from the current position to the point to stake out.
Distance to point	Distance from the current position to the point to stake out.
Defined easting	Easting of the point to stake out.
Defined northing	Northing of the point to stake out.
Defined height	Height of the point to stake out.
Actual easting	Easting of the current position.
Actual northing	Northing of the current position.
Current design east	Easting of the design for the current position. Relevant point at the selected line.
Current design north	Northing of the design for the current position. Relevant point at the selected line.
Current design height	Height of the design for the current position. Relevant point at the selected line.
3D quality	Standard deviation of the point measurement.
Height of lower rail	Height of the lower rail at current chainage.
Height difference lower rail	Height difference between the measured point and the lower rail.
Current design super-elevation	Design cant at the current position.
Ref offset	Horizontal distance between the measured point and the rail or centreline being used as a reference.
Ref height diff	Height difference between the measured point and the rail or centreline being used as a reference.
Offset (using super-elevation)	Offset calculated regarding the cant.
Height difference (using super-elevation)	Height difference calculated regarding the cant.

Field	Description
Rail task	Name of the current task.
Rail name	Name of the centreline or rail being used as a reference.
Defined design cant	Design cant at the defined chainage.
Pendular length	The pendulum length as distance value: The difference in elevation of the pendulum centre on the original track and above the axis point.
Def pendulum displacement	The defined horizontal displacement for the track.
Def pendulum angle	The pendulum displacement and the superelevation (cant) define the pendulum angle.
Actual pendulum displacement	The current horizontal displacement for the track.
Separator and Unused line	Empty line.
Current super-elevation	Available for Check. Superelevation of the current position. This value is calculated by using the 'Second Point of Cant' option, which is located in the toolbox.
Measured super-elevation	Displays the value entered on Check Track ,  page. The value is measured with a camber measurement instrument.
	 Using Second Point of the toolbox, Measured super-elevation on the  page is set to ----- and is not stored in the DBX. The current cant value of Second Point is used and not the manually entered measured cant value.
Super-elevation difference	<p>The calculation depends on the setting for Use super-elevation in Road Settings, Rail design page:</p> <ul style="list-style-type: none"> For Use super-elevation: From design: Super-elevation difference = Measured cant - Current design cant For Use super-elevation: Enter manually: Super-elevation difference = Measured cant - Manually defined cant of Check Track,  page For Use super-elevation: Show message: Super-elevation difference = -----
	Also available for Stake: Track & gauge device or Rails & gauge device:
Director rail offset difference	Difference between the theoretical position of the rail director and the measured position.
Left rail height difference	Height difference between the theoretical left rail position and the measured position.

Field	Description
Right rail height diff	Height difference between the theoretical right rail position and the measured position.
Measured gauge	Gauge value measured by the gauge device.
Measured gauge	Cant value measured by the gauge device.
Difference in gauge	Difference between the nominal gauge and the gauge measured from the gauge device.
Go forward/backward	Distance to point. Available for staking. For Navigational arrow types: In/out, left/right in 3D viewer equivalent to:



Go left/right Distance to point. Available for staking.
For **Navigational arrow types: In/out, left/right** in 3D viewer equivalent to:



Go Distance to point. Available for staking.
For **Navigational arrow types: Direction & distance** in 3D viewer equivalent to:



Turn left/right Direction to point. Available for staking.
For **Navigational arrow types: Direction & distance** in 3D viewer equivalent to:



43.3.10

Tunnel - Info Page - TS

Available fields

The following parameters are available. All fields are display only.

Field	Description
Line task	Name of the current task.
Difference in offset	Horizontal offset between the defined position and the current position.
Difference in height	Vertical offset between the defined position and the current position.

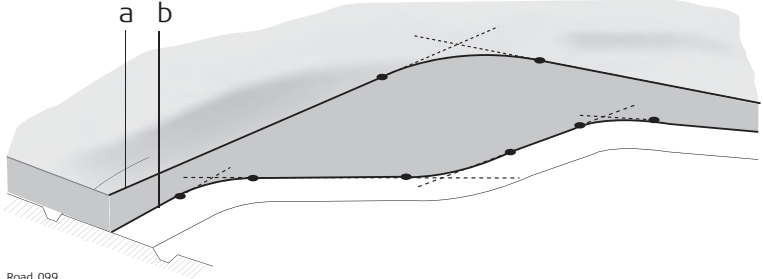

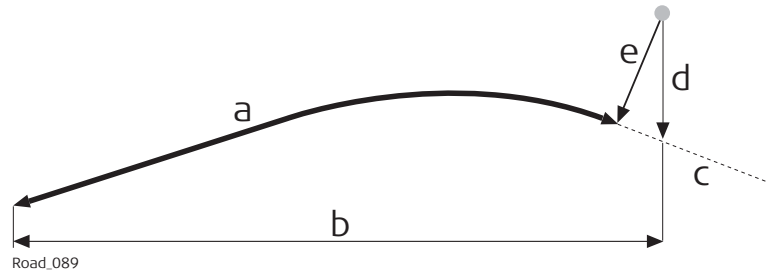

Field	Description
Difference in chainage	Difference between the defined chainage and the current chainage. ☞ If no defined chainage exists, for example if staking out random chainages or checking, this field reads Difference in chainage: ----- .
Chainage	The current chainage. This field is independent of the chosen settings for Help me navigate and Navigational arrow types in Road Settings, Graphics page.
Line offset	Horizontal offset from the line.
Line name	Name of the line to stake out or the stakeout is relative to.
Line height difference	Height difference from the centreline.
Height difference at 3D chainage	Offset perpendicular to the vertical component of the selected line. This value can be useful when dealing with pipelines, cables and in the construction segment.
CL height	Height of the centreline at the current chainage.
CL radius	Radius of the centreline at the current chainage.
CL type	Element type of the centreline.
CL offset	Perpendicular horizontal offset from the centreline. This field is independent of the chosen settings for Help me navigate and Navigational arrow types in Road Settings, Graphics page.
CL tangent	Tangent direction of the centreline at the current chainage.
Nearest hz tangent point	The chainage difference between the measured point and the nearest tangent point of the design is displayed. The nearest tangent point is the start/end point of a road segment.
	 <p>Road_099</p> <p>a Vertical alignment b Horizontal alignment</p> <p>Only tangent points are detected. The tangent point is the start/end point of a road segment.</p>
Nearest vertical tangent point	Distance to the nearest vertical tangent point of the design.
3D chainage	Chainage of the measured point is projected perpendicular to the vertical component of the selected line.

Field	Description
-------	-------------



- a **3D chainage**
- b Chainage
- c Centreline
- d Centreline height difference
- e **Height difference at 3D chainage**

Centreline grade	Grade of the centreline at the current position.
Direction to point	Direction from the current position to the point to stake out.
Distance to point	Distance from the current position to the point to stake out.
Defined easting	Easting of the point to stake out.
Defined northing	Northing of the point to stake out.
Defined height	Height of the point to stake out.
Actual easting	Easting of the design for the current position. Relevant point at the selected line.
Actual northing	Northing of the design for the current position. Relevant point at the selected line.
Actual height	Height of the design for the current position. Relevant point at the selected line.
3D quality	Standard deviation of the point measurement.
Separator and Unused line	Empty line.
Difference to profile	Distance from the design profile to the measured point.
Element number	Element number of the closest design profile element to the measured point.
Element (%)	Distance in percentage terms of the measured point along the design profile element.
Dist along profile	Distance of the measured point along the design profile starting at the origin of the profile.
Top distance	Distance of the measured point along the design profile starting at the top of the profile.

Field	Description
CL offset rotated	Perpendicular horizontal offset from the current position to the centreline, along the X-axis of the rotated tunnel profile
Centreline height diff rotated	Height difference from the current position to the centreline along the Y-axis of the rotated tunnel profile.
Go forward/backward	Distance to point. Available for staking. For Navigational arrow types: In/out, left/right in 3D viewer equivalent to: 
Go left/right	Distance to point. Available for staking. For Navigational arrow types: In/out, left/right in 3D viewer equivalent to: 
Go	Distance to point. Available for staking. For Navigational arrow types: Direction & distance in 3D viewer equivalent to: 
Turn left/right	Direction to point. Available for staking. For Navigational arrow types: Direction & distance in 3D viewer equivalent to: 

43.3.11

Workflow for Height (aim to stake ht) - for TS

Step-by-step

In this example, the height of the surface grade is marked on a peg by using the auto position function.

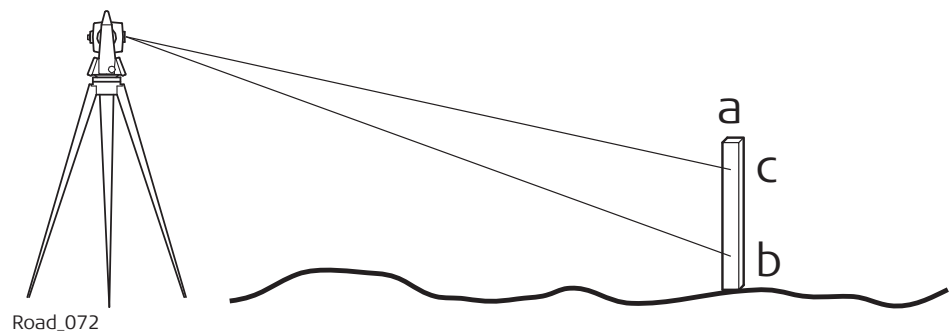



- a Peg placed at the correct position
 - b First height, manually chosen direction
 - c Required height on the peg
1. In the **Road Settings, TS specific** page, select **Automatic behaviour: Prompt before turn**.

 -  Make sure that the instrument uses the reflectorless EDM mode.
 2. After staking out the peg at the correct position with **Prompt before turn**, aim the instrument at the peg.

 3. Press **Fn Position** to open the **Settings** panel.

 4. **Settings**
Highlight **Height (aim to stake ht)**.

 5. Press **OK**.

 -  The instrument searches for the point on the peg at the required height without changing the horizontal direction.
 -  As soon as the defined **Upper height limit/Lower height limit** from **Road Settings, Quality control** is reached, the instrument stops.
 -  Depending on the settings chosen, the instrument turns on the red laser to mark the height.

43.4

Working with Shifts

Description

When working on site, often design data does not match the measured data. For example, an existing road surface that should intersect with the design surface may be 15 cm higher than the plans indicate. To guarantee a smooth intersection, this difference has to be distributed over the remaining 100m of paving. To handle these situations, shifts can be added to the existing design data. A shift is applied when selecting the element to stake out/check.

Horizontal and vertical shifts can be applied to the selected element. By using these shifts the design can be lifted/lowered and moved horizontally.

A shift is always an overlay of the existing design and is stored with the task. For a horizontal alignment, the shift is applied perpendicular to the centreline. For the vertical part of the alignment, shifts are applied following the plumb line.



Shifts are applied temporarily to the design data. The original design data is not modified when a shift is applied.

Access

Press **Shifts** in the Define panel.

Define Shifts, Horizontal shift/ Vertical shift/ Scale profile page

The parameters required for applying the shift are identical for all entities.

Description of fields

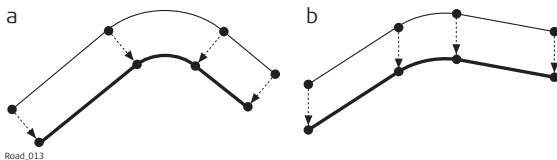
Field	Option	Description
Apply horizontal shift/ Apply vertical shift	Check box	<p>When this box is checked, shifts can be defined.</p> <p>Horizontal shifts are always rectangular to the centreline of the element being worked with. Whereas vertical shifts are defined along the plumb line.</p>  <p>a Horizontal alignment with constant shift</p> <p>b Vertical alignment with constant shift</p>

Shift type

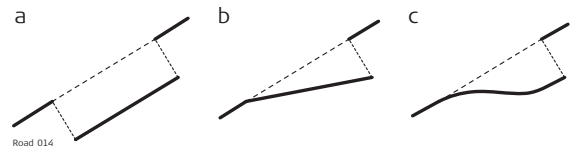

- a Constant shift
- b Linear shift
- c Parabolic shift and reverse curve

Linear	The difference between the shift at the begin chainage and the shift defined at the end chainage is distributed in a linear fashion.
Constant	A constant shift is applied from the begin chainage of the shift to the end chainage of the shift. The shift stays the same from its start chainage or station to the end chainage or station.
Parabolic	Available for Road and Rail. The difference between the shift at the begin chainage and the shift defined at the end chainage is distributed using a cubic parabola. Parabolic shifts allow a smooth transition between the existing curve and the shifted part.
Reverse curve	Available for Road and Rail. Two arcs with the same radius are used to distribute the shift. As for parabolic shifts, reverse curves guarantee a smooth transition between the existing curve and the shifted part.

Field	Option	Description
-------	--------	-------------

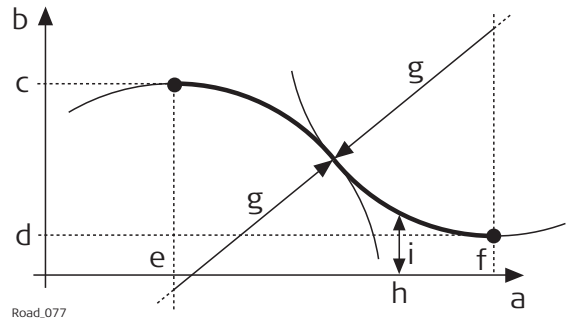

- a Chainage
- b Shift
- c Start shift at chainage (e)
- d End shift at chainage (f)
- e Start chainage of the shift
- f End chainage of the shift
- g Radius of the two arcs used as transition curve
- h Random chainage between (e) and (f)
- i Shift applied at chainage (h)

Start chainage	Editable field	Chainage from which the shift is applied.
Start shift	Editable field	Magnitude of the shift to apply at the begin chainage.
Shift value	Editable field	Available for Shift type: Constant . The magnitude of shift.
End chainage	Editable field	Chainage at which the shift ends.
End shift	Editable field	Magnitude of the shift to apply at the end chainage.

Outside of entered shift

Available for Road and Rail. Defines the object outside of the defined shift range.

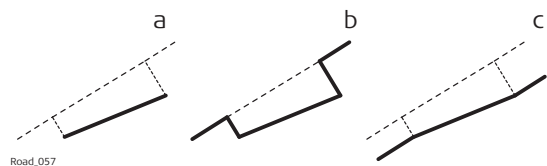

- a **Show message**
- b **Use alignment**
- c **Continue with parallel shift**

Show message

The object only exists within the defined shift range.

Continue with parallel shift

The begin shift and the end shift are continued parallel. The start shift is used from the start of the alignment until the start chainage. The end shift is used from the end chainage until the end of the alignment.

Field	Option	Description
	Use alignment	Before/after the defined shift range, no shift is added. Outside of the defined shift area the original design is used. This option means a "step" appears at the start and/or end of the shifted area.

Plot with shifts

In the 3D viewer, the design data is shown in its original position. The point to stake symbol is shown in its shifted position.

Sign convention for shifts

The sign convention for design shifts is identical to the convention used for stake offset and height difference.

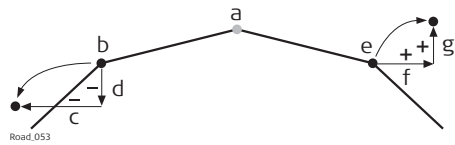

- a Centreline
- b Line on left side
- c Negative horizontal shift
- d Negative vertical shift
- e Line on right side
- f Positive horizontal shift
- g Positive vertical shift



Horizontal stake offsets are always defined perpendicular to the centreline of the layer the line/s belongs to.

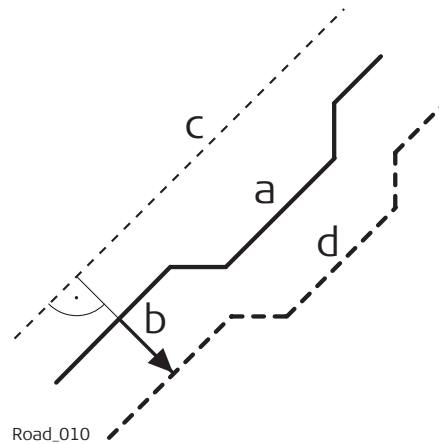

- a Line the horizontal shift is applied to
- b User defined horizontal shift for the line
- c Centreline
- d Shifted line

Shifts for lines, slopes, layers and DTMs

The shifts applied to lines, slopes, road crowns layers and DTMs are identical with one exception: Given that DTMs are not defined relative to a centreline and hold no orientation information, no horizontal shift is possible for a DTM.

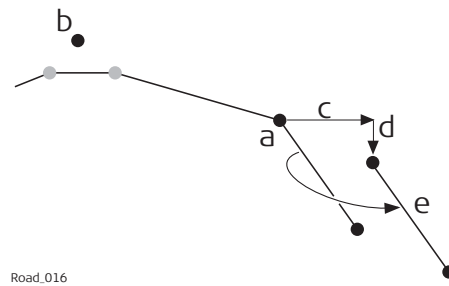

- a Slope to shift
- b Centreline
- c Value for horizontal shift
- d Value for vertical shift
- e Shifted slope

Shift for surface grade and road crowns

Description

To allow widening and narrowing of surface grade and road crowns, only one of the two lines defining the surface grade or crown, is shifted when adding a horizontal shift. This behaviour is useful for small changes to the original design, for example to bus stops or emergency bays.

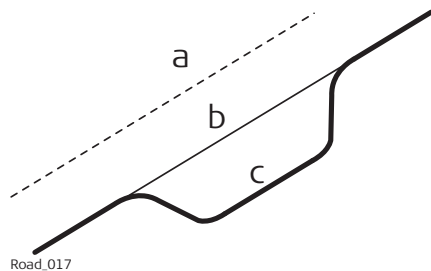

- a Centreline
- b Original line of the design
- c Line with horizontal parabolic shift

Horizontal shift

For surface grades and crowns, the horizontal shift is added to the line that is defined as the reference line. To maintain the original surface grade/crown ratio the line is shifted along the surface grade/crown.

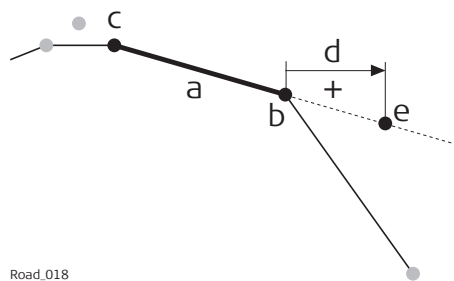

- a Surface grade to shift
- b Reference line of the surface grade
- c Second line of the surface grade
- d Positive horizontal shift
- e Position of the shifted reference line

Vertical shift

The vertical component of the shift for a surface grade or crown is applied to all lines.

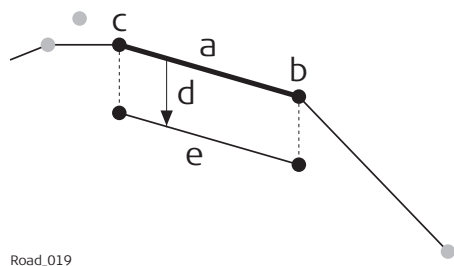

- a Surface grade to shift
- b Right line of the surface grade
- c Left line of the surface grade
- d Negative vertical shift
- e Shifted surface grade

Horizontal alignment with constant horizontal shift

Horizontal shifts are always perpendicular to the centreline.

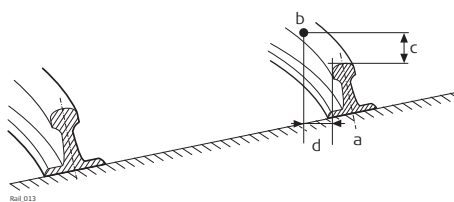

Plan view

- a Reference line
- b Point to stake
- c Stake height difference
- d Stake offset

Description

When staking out or checking a road/rail/tunnel, often it is not possible to finish a particular task in one go. The element to be staked out or checked can be stored together with all defined settings as a work task.

Stored in a task are:

- Selected layer
- Working chainage
- Selected line(s) or element
- Shifts

Tasks are stored within the selected Road/Rail/Tunnel job. They can be created at any time when working in the field or during preparation in the office.

Deleting a task does not delete the referenced jobs.

Deleting a Road/Rail/Tunnel job deletes all referencing tasks.

Tasks are method-specific.

Creating a task

1. Start the Roads/Rail/Tunnel app.
2. Select a method, if necessary, and press **OK**.
3. In the Define panel press **Save task**.
4. Type in a name for the task and press **OK**.

**Load a Defined Task/
Load a Defined Rail
Task/
Load Defined Tunnel
Task**
Access

Press **Load** in the Define panel.



Key	Description
OK	To select the highlighted task and continue.
Delete	To delete the selected task.
More	To display information about Date , Time , Creator and Description .
Fn Name or Time	To sort task list by name or time.

Terms and expressions

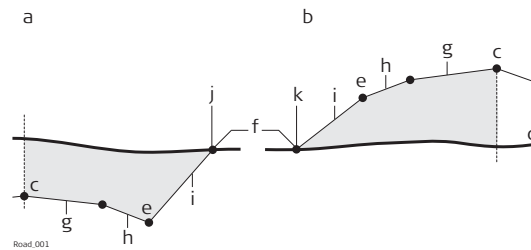

- a Cut situation
- b Fill situation
- c Centreline
- d Natural surface
- e Hinge point
- f Catch point
- g Carriage way
- h Shoulder
- i Slope
- j Top
- k Toe

Term / expression	Description
Carriage way	The part of the road on which users drive once the road is finished.
Shoulder or Verge	Often located next to the carriage way, usually with a slightly higher slope ratio than the carriage way.
Slope	Located next to the verge and can be thought of as linking the road level with the natural surface. The ratio of the slope is greater than the ratio of the verge. A slope starts at the hinge point.
Natural surface or original ground	The undisturbed surface before project construction.
Finished road level	Describes the final road surface.
Catch point or daylight point	Indicates the point of intersection between the slope and the natural surface. Both the hinge point and the catch point lie on the slope. For a cut slope, the catch point forms part of the top of a bank. For a fill slope, the catch point forms part of the bottom of a bank.
Chainage or station	The cumulative distance along the centreline, frequently but not always starting at zero.

Horizontal alignment

The app supports the following elements in the horizontal component of alignments:

- Straights
- Arcs
- Clothoid, entry and exit as well as partial
- Cubic parabolas, entry and exit as well as partial
- Bloss curves, entry and exit as well as partial; only available for Rail
- Multipoints, all other elements than the previous types. Discrete points along the curve represent multipoints. For example, a line parallel to a clothoid.

Vertical alignment

The app supports the following elements in the vertical component of alignments:

- Straights
- Arcs
- Quadratic parabolas
- Asymmetric quadratic parabola
- Multipoints, all elements that cannot be described by one of the previous types are represented by discrete points along the curve.

43.6.3

Road - Basic Elements for Stake and Check Measurements

Description

In general, there are four different basic stakeout and check elements:

- Surface grades, for example, the final carriage way
- Lines, for example, a centreline
- Slopes, for example, the end-slopes of a cross section
- Surfaces, for example, a DTM surface

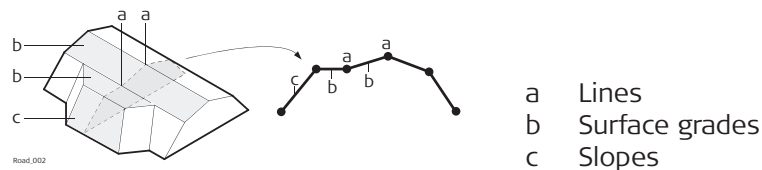

Every stakeout or check is based on one or more of these four base elements. For example, a road crown consists of two surface grades with one common line.

Lines

The stake out of a line is used in different situations:

- Centre line of a road
- Edges of a road or any other change in slope
- Gutters
- Pipelines, cables and any other line-related design feature

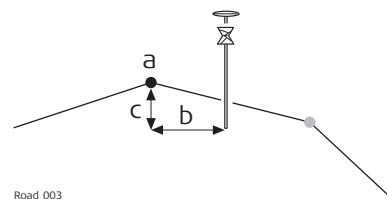

- a Line to stake out or check, in this case the centreline
- b Line offset
- c Line height difference

Surface grades

Surface grades are defined by two lines. The two lines define the right and left edge of the surface grade. One of the two lines is used as the reference line.

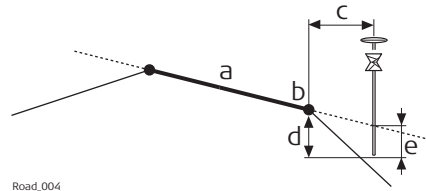

Road_004

- a Surface grade to stake out or check
- b Reference line
- c Horizontal offset to reference line
- d Height difference to reference line
- e Height difference to expanded surface grade

Slopes

Slopes, like surface grades, are defined by two lines. Different to surface grades, only one edge of the slope, the hinge point, is known. The second edge, catch point or daylight point, is defined by the intersection of the slope and the natural surface. As the natural surface is unknown this edge can only be staked out in the field. Finding and staking out the catch point is the most important task when working with slopes.

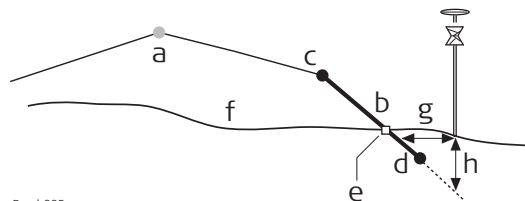

Road_005

- a Centreline
- b Slope
- c Hinge Point
- d Second line defining the slope
- e Catch point
- f Natural surface
- g Δ Offset from the slope
- h Height difference from the slope

Surfaces

There are two types of surfaces supported that represent a three-dimensional design:

- DTM / TIN (**D**igital **T**errain **M**odel; **T**riangular **I**rrregular **N**etwork)
- Layer

A DTM consists of several 3D triangles. DTMs do not include information relating the DTM to a centreline. Positions are defined by easting, northing and height values.

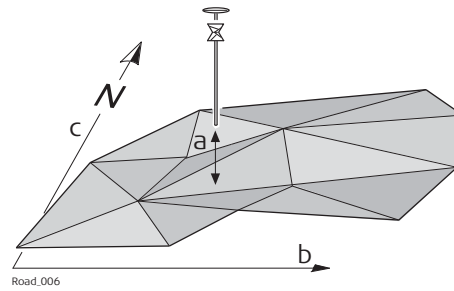

- a Height difference from the triangle of the DTM found in the same vertical line as the measured point
- b Easting of coordinate system
- c Northing of the coordinate system

A layer is a combination of lines that form a 3D surface relative to a centreline. Thus it is possible to define points by chainage or station, offset and height. Refer to "43.2.3 Design Data" for more information.

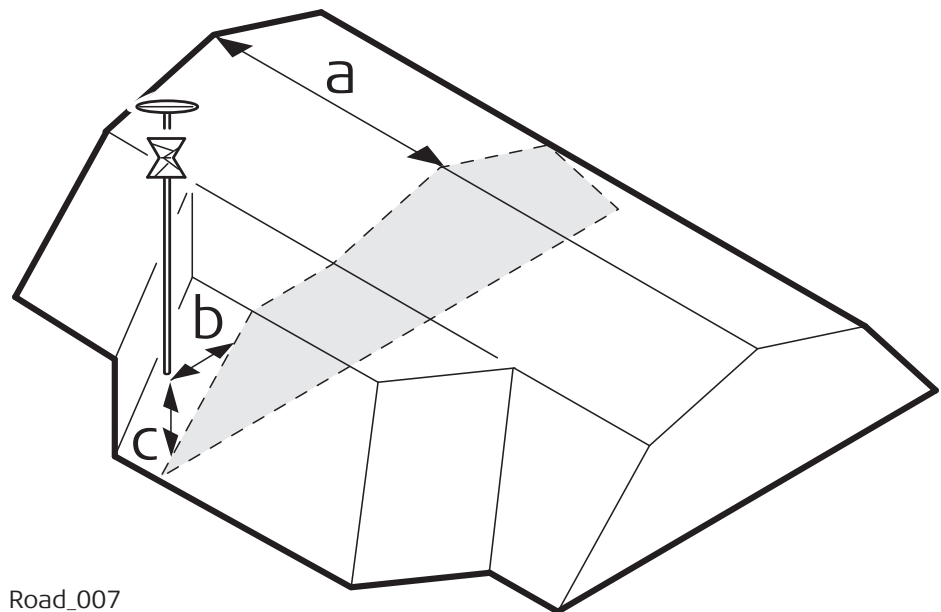

- a Chainage or station
- b Layer Offset
- c Layer height difference

43.6.4

Road - Stake Offset and Stake Height Difference

Description

When conducting a stake out, the aim is usually to mark the position of geometric elements defined by the design. For example, in the graphic below, the catch point of a slope. A point can be staked either directly or indirectly. For a directly staked point, the peg ends up at exactly the position of the point to be staked. Staking the same point indirectly, the peg will be placed with a certain offset to the point.

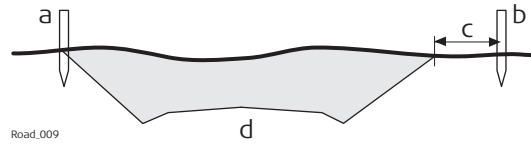

One reason to stake out a point indirectly is that the peg would not last long at the position of the actual point. In this example, the peg staked directly would be removed as soon as the excavation work starts.



Horizontal stake offsets are, like shifts, defined perpendicular to the centreline of the layer the line(s) belongs to, if no offset angle has been defined. For surface grades and road crowns, the stake offset is applied following the same rules as stated for horizontal shifts. Refer to "43.4 Working with Shifts" for more information.

Stake offset

For each stakeout method, a horizontal and/or vertical offset can be defined. The stake offset and stake height difference are defined on the  page of the stake panel.

Sign convention for stake offset and height difference

The sign convention for stake offsets and height differences is identical to the convention used for design shifts.

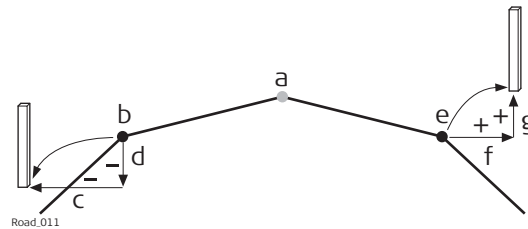

- a Centreline
- b Line on left side
- c Negative stake offset
- d Negative stake height difference
- e Line on right side
- f Positive stake offset
- g Positive stake height difference

Map with stake offset and stake height difference

The app offers for all stakeout methods a page showing a graphical representation of the measured position in relation to the design. If stake offset and/or stake height difference are used, the map shows the original cross section view of the design as well as the position to stake out. A yellow/black peg marks the position to stake out.

43.6.5

Road - Chainage or Station Equations

Description

Chainage or station equations are used to adjust the alignment chainage or station. The most common reason for doing so is the insertion or removal of curves during the design process. Inserting or removing a curve would require recalculating the chainage or station of an entire alignment. Using chainage or station equations eliminates this need. Chainage or station equations can create either a gap or an overlap as shown in the following diagrams.

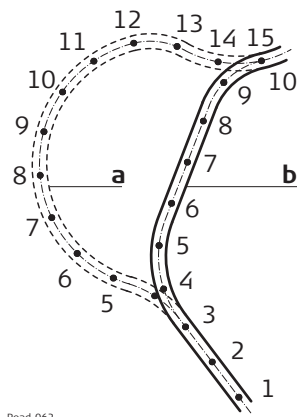

Road_062

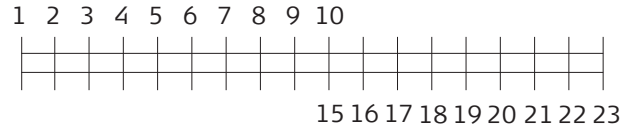

Gap chainage or station equation. Chainage or station back 10 = chainage or station ahead 15.

- a Old
- b New

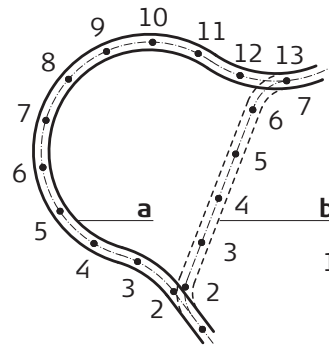

Road_063

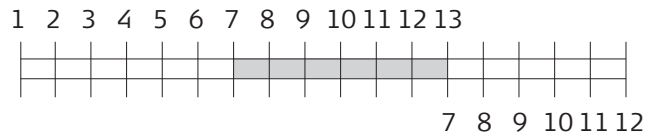

Overlap chainage or station equation. Chainage or station back 13 = chainage or station ahead 7.

- a New
- b Old

Multiple chainage or station

In the case of the overlap shown in the example, the chainages or stations between seven and thirteen appear twice. When a duplicate chainage or station is entered, a message asks which one is to be used.

Example

As more than one chainage or station equation is possible, a chainage or station can appear more than twice on a design. In this example, the chainages or stations 11 to 13 appear three times.



Road_069

Overlap chainage or station equation. Chainage back 13 = chainage ahead 7 and chainage back 15 = chainage ahead 11.

Example: Chainage or station 12 is entered in **Road - Multiple Chainage**. The following panel shows how the option to select the right chainage or station is displayed:

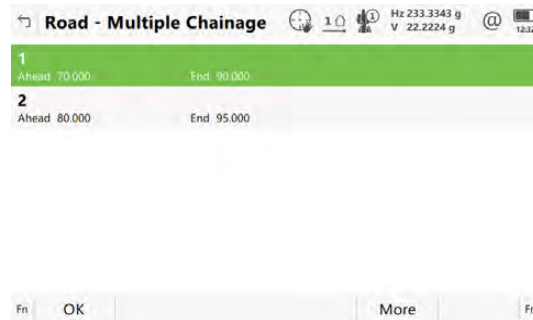

Key	Description
OK	To select the highlighted chainage or station equation and return to the stakeout panel.
More	To switch the value displayed in the last column to show the end chainage or station of the chainage or station equation.

Description of metadata

Metadata	Description
End	Shows the end chainage or station for the chainage or station equation. End shows to which chainage or station, the current chainage or station equation is valid. If for the first part of the alignment, no chainage or station equation exists, Ahead stays empty for the first row.

43.6.6

Road - Working Corridor

Description

A working corridor defines the valid offset range left and right of the centre-line. When working with irregular alignments such as traffic islands and parking

lots, working corridors are useful to avoid displaying results from the wrong centreline element.

The following example shows the result if working without a defined working corridor. For the measured position (b), the app finds the centreline point (c) with the minimum perpendicular offset (f).

With a defined working corridor (e), the app would display a message advising that the measured position is outside of the defined centreline.

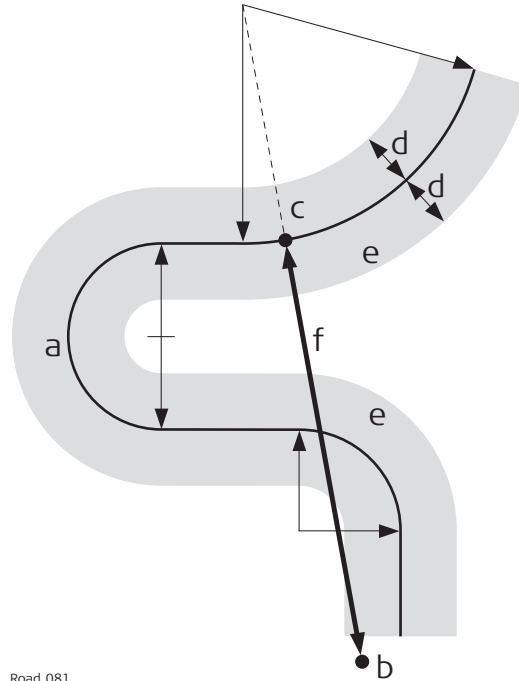

Road_081

- a Centreline
- b Measured position
- c Projected point on the centreline
- d Defined offset range for the working corridor
- e Working corridor
- f Offset from the centreline, if no working corridor is used

The working corridor is defined in **Road Settings, Design** page. Refer to "43.3 Configuring Roads Apps" for more information.

43.6.7

Road - Extension of the Centreline

Description

Whenever centrelines must be extended, for example, at the start and end area of an alignment or slope. The projection of the measured position to the centreline is made using the tangent of the start/end point of the centreline.

In this case, a warning appears informing that the original design is exceeded. The app advises as soon as a measured position is within the design area once again.

Concept

When expanding the centreline the geometry will be continued using the tangent of the start/end point of the centreline.

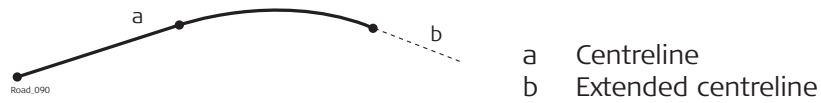

Method

Description

When staking out in the region of the start/end area of the design centreline, situations occur where an expansion of the centreline is useful. As soon as measurements are outside the defined centreline, the app prompts if and with which method the centreline should be expanded.



The extension of a centreline is made following its start/end tangent. Outside of the original design area correct results cannot be guaranteed.

43.6.8

Road/Rail - Working with Heights

Description

Normally, heights stored with the design data are used. The Rail app offers the possibility to switch to either:

- a height which is entered manually.
This option enables the manual definition of a height, which can be applied for staking out or checking. This height is entered in the / / / page.
- a height which is retrieved from an existing height layer, as defined in the DTM job associated with the project. The layer from the DTM is applied and used as a height reference for the staking out or checking of alignments. 2D and 3D are possible.

This option is configured in the toolbox.

Understanding priorities of various heights

Type of height	Overrules	Stake Height Diff
Manually entered	All other heights	Considered
Of individual point	All other heights	Considered
From height layer of DTM	Design height	Considered
From design	No other heights	Considered

43.6.9

Rail - Working with a Single Track

Terms and expressions

Term / expression	Description
Track	A track comprises two separate rails.
Single track	A single track is defined as one track with one centreline and two rails. All chainages are calculated from the centreline.
Track centreline	Geometric alignment in two or three dimensions to which all design elements of the project are referenced. It could be that the vertical component of the alignment does not coincide with the plan component. In this case the vertical part of the alignment will generally coincide with the lowest rail.
Chainage or station	The cumulative distance along the centreline, frequently but not always starting at zero.

Term / expression	Description
Left/right rail	<p>Planimetric position of the left/right rail of a track.</p> <p>The sense of the left/right rail is given by the direction of increasing chainage.</p> <p>When a section of the track is viewed in the direction of increasing chainage, the left rail is to the left of the centre of the track.</p>
Nominal gauge	The nominal distance between the active (internal) faces of the left and right rails.
Superelevation base	The distance over which the superelevation is applied. This distance is normally the distance between the centre of the left and right rail.
Left/right superelevation Left/right cant	<p>The superelevation or height difference of each rail with respect to the track centreline. Usually expressed in millimetres.</p> <p>If one of the rails is used to rotate the track section, or the height of the vertical alignment coincides with the lowest rail, the superelevation of the rotation point or lowest rail will be zero.</p> <p>Superelevation is also known by the term cant. These two words can be interchanged.</p>

Diagram - Plan

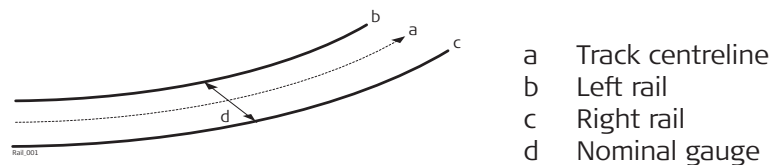
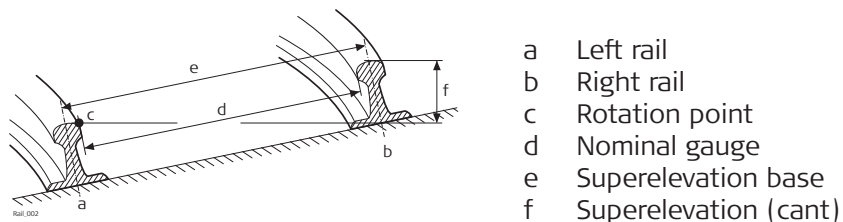

Diagram - Section

Two generic methods can be used to define the section of the track.

Method 1 - A definition using rotation around a known point

This method involves rotating the section around a known point, normally the lowest rail.



Method 2 - A definition using relative height distances

This method uses height differences relative to the vertical alignment to define the height of the left and right rail.

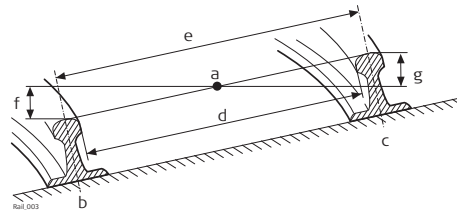

- a Track centreline
- b Left rail
- c Right rail
- d Nominal gauge
- e Superelevation base
- f Left superelevation (left cant)
- g Right superelevation (right cant)

43.6.10

Rail - Working with Multiple Tracks

Description

Multiple tracks are used when more than one track share a common centreline, from which all chainages are calculated.

When there are multiple tracks with independent centrelines for each track, each track is then considered as a single track. Refer to "43.6.9 Rail - Working with a Single Track" for details on single tracks.

Diagram - Plan

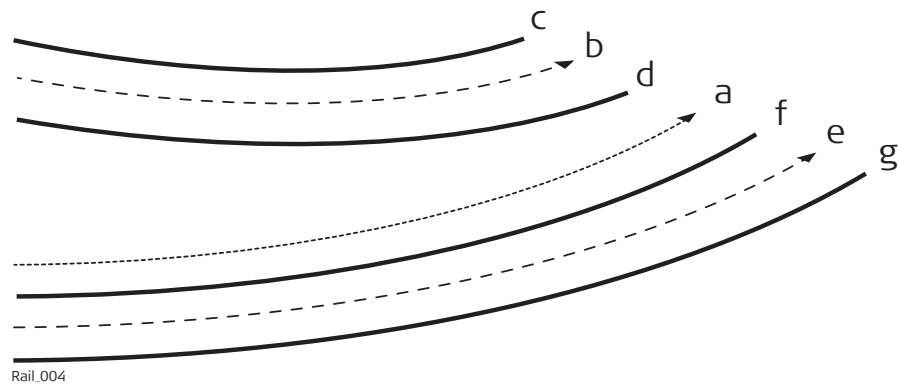

- a Chainage centreline
- b Left track centre line
- c Left track left rail
- d Left track right rail
- e Right track centreline
- f Right track left rail
- g Right track right rail

Diagram - Section

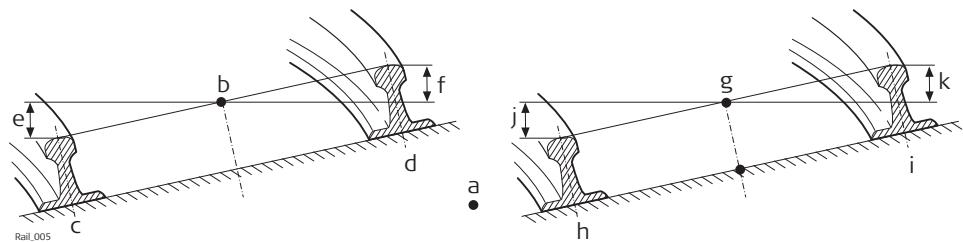

- a Chainage centreline
- b Left track centreline
- c Left track left rail
- d Left track right rail
- e Left track left rail superelevation
- f Left track right rail superelevation
- g Right track centreline
- h Right track left rail
- i Right track right rail
- j Right track left rail superelevation
- k Right track right rail superelevation

Calculations

For multiple tracks, the chainage centreline is used only to calculate the chainage. The superelevation of each track is calculated with respect to the corresponding (left / right) vertical alignment. The chainage centreline can consist of a plan and a vertical component. Although the vertical component of the chainage centreline is not used for any calculation.

43.6.11

Rail - Check Elements and Stakeout Elements

Description

Points can be staked with respect to three basic elements of the track:

- Track centreline
- Left rail
- Right rail

Centreline stakeout

Description

The line to stake out can be a track centreline or, in the case of multiple tracks, the left or right track centreline. In both cases, a horizontal offset with respect to the centreline can be applied. Additionally, if a vertical alignment is available for a track centreline, a vertical offset can be applied.

Diagram - Single track elements

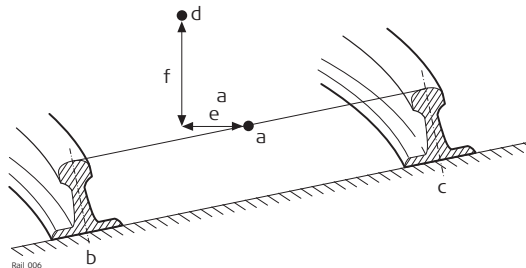

- a Track centreline
- b Left rail
- c Right rail
- d Point to stake
- e Horizontal offset from track centreline
- f Vertical offset from track centreline

Left/right rail stake-out

Description

The left or right rail of a track can be staked out:

- directly,
- horizontal and/or vertical offsets can be used to stake any point relative to either rail.

Diagram - Staking out a point relative to the right rail

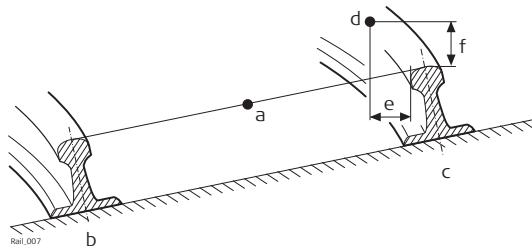

- a Track centreline
- b Left rail
- c Right rail
- d Point to stake
- e Horizontal offset from right rail
- f Vertical offset from right rail



The position from which the horizontal and rail offsets will be applied depends on how the left and right rails were defined in the imported design data. Using standard practice, the horizontal offset would be defined from the active face of the rail, and the height offset would be defined from the highest part of the rail, as shown in the diagram.

43.6.12

Rail - Working with Offsets

Sign convention for offsets

The sign convention for offsets is:

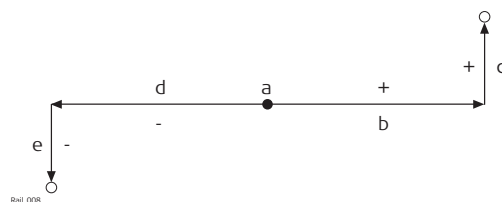

- a Centreline
- b Positive horizontal offset
- c Positive vertical offset
- d Negative horizontal offset
- e Negative vertical offset

43.6.13

Tunnel - Basic Terms

Terms and expressions

Term/Expression	Description
Centreline	Geometric alignment in two or three dimensions to which all design elements of the project are referenced.

Term/Expression	Description
Chainage or station	The cumulative distance along the centreline, frequently but not always starting at zero.
Design Profile	Geometric description of the designed shape of the cross-section of the tunnel. The design profile can contain straight or curve elements.
Excavated Profile	Shape of the cross-section of the tunnel that has been excavated.
Underbreak	When the excavated profile is inside the design profile, the underbreak is the perpendicular distance between the design profile and the excavated profile.
Overbreak	When the excavated profile is outside of the design profile, the overbreak is the perpendicular distance between the design profile and the excavated profile.
Tunnel Portal	The open end of a tunnel.
Tunnel Face	The point where the excavated tunnel meets existing terrain.
Superelevation (Rotation)	Angle of rotation of a design profile. Used to take into account the velocity of a moving vehicle through a curve.
Rotation Point	The point about which the design profile is rotated. This point may or may not coincide with the centreline.

General terms

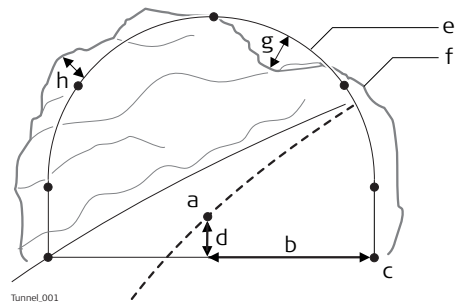

- a Centreline
- b Centreline offset
- c Point on design profile
- d Centreline height offset
- e Design profile
- f Excavated profile
- g Underbreak
- h Overbreak

3D View

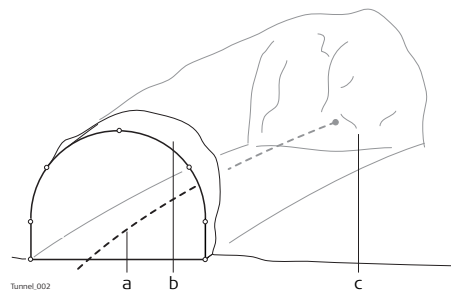

- a Centreline or axis
- b Tunnel portal
- c Tunnel face

Superelevation

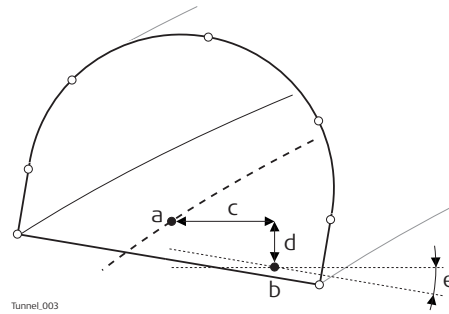

- a Centreline or axis
- b Rotation point
- c Centreline offset
- d Centreline height offset
- e Superelevation (Rotation)

43.6.14

Tunnel - Elements for Stake and Check Measurements

Tunnel face

Staking tunnel faces

It is usually required to stake out the tunnel face to indicate the position to excavate when certain tunnelling methods are used. For example, Drill and Blast or excavation using a roadheader.

The points to stake on the tunnel face can be defined in various ways:

Horizontal and vertical offsets

By horizontal and vertical offsets with respect to the centreline:

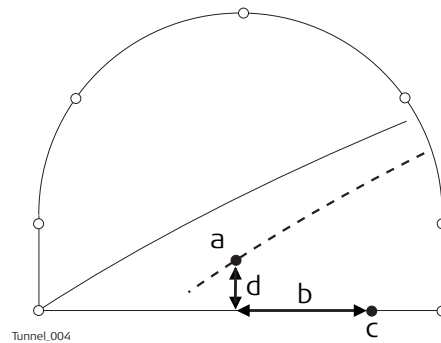

- a Centreline
- b Point on tunnel face to stake
- c Centreline offset
- d Centreline height offset

Distance along profile

By the distance from the start of the design profile and an offset from the design profile.

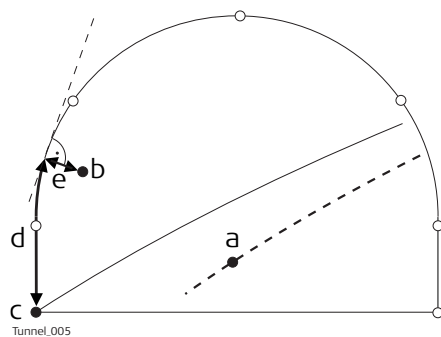

- a Centreline
- b Point on tunnel face to stake
- c Point defining start of design profile
- d Distance from start of design profile
- e Offset perpendicular to design profile

Distance along a particular element

By the distance along a particular element of the design profile and an offset from the element.

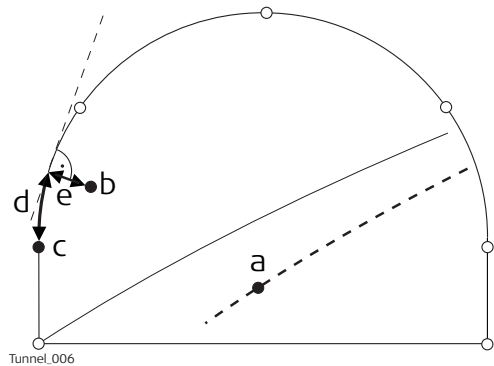

- a Centreline
- b Point on tunnel face to stake
- c Element of design profile to stake
- d Distance from start of design profile element
- e Offset perpendicular to design profile

Tunnel profiles

Staking tunnel profiles

Tunnel profiles are normally staked after excavation to indicate the position of tunnel design elements or services such as lighting or ventilation.

Basic terms

Usually a tunnel under construction is designed and built in various stages such that a given chainage can have various design profiles. For example shotcrete or final lining. Each design profile is called a layer.

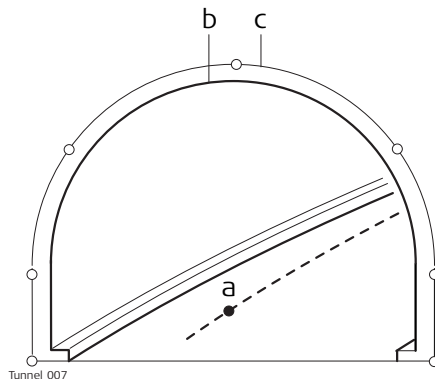

- a Centreline or axis
- b Final lining
- c Shotcrete

Measuring tunnel profiles

Tunnel profiles are normally measured after excavation to compare the excavated profile with the design profile. This check can occur during the excavation phase of the project or for quality control checks of the built tunnel.

When measuring tunnel profiles, it is possible to scan various profiles from one instrument position. The profiles to scan are defined with respect to a defined chainage. Profiles can be scanned at a given forward and back interval within a given forward and back distance from the defined profile.

Measuring tunnel profiles - Plan view

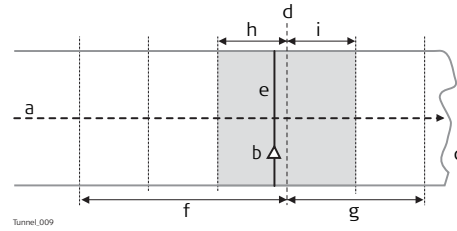

- a Centreline
- b Instrument position
- c Tunnel face
- d Defined profile to scan
- e Instrument profile
- f Back distance
- g Forward distance
- h Back interval
- i Forward interval

Profile view

Tunnel profiles can be measured vertically, horizontally or perpendicular to the tunnel centreline.

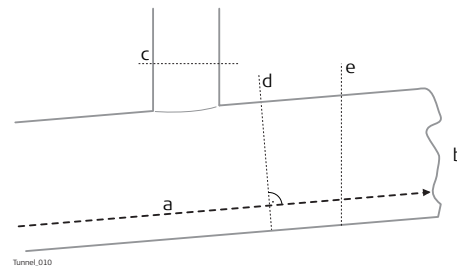

- a Centreline
- b Tunnel face
- c Horizontal profile
- d Profile perpendicular to centreline
- e Vertical profile

43.6.15

Tunnel - Shifts

Description

When working on site, often design data does not match the measured data. For example, an existing road surface that should intersect with the design surface may be 15 cm higher than the plans indicate. For a smooth intersection, this difference is distributed over the remaining 100 m of paving. To handle these situations, the app allows the possibility of adding shifts to the existing design data. A shift is applied when selecting the element to stake out/check.



Shifts do not change the stored design. They are applied temporarily for stake out purposes.

Centreline shifts

Horizontal and vertical shifts

Horizontal shifts are always perpendicular to the centreline whereas vertical shifts are applied along the plumb line.

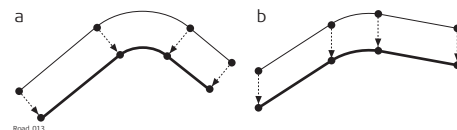

- a Horizontal alignment with constant shift (plan view)
- b Vertical alignment with constant shift (profile view)

Constant and linear shifts are supported

For both horizontal and vertical shifts, two different types can be applied:

- Constant:** The shift remains the same from its start chainage or station to the end chainage or station.

Linear: The shift is linearly interpolated along the chainage or station.

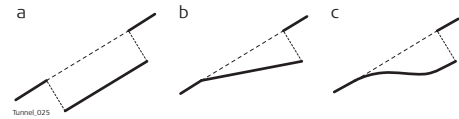

- a Constant shift
- b Linear shift

Sign convention

The sign convention for design shifts is identical to the conventions used for centreline offset and height shifts difference.

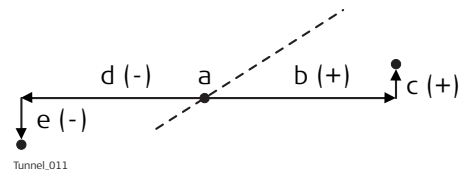

- a Centreline
- b Positive horizontal shift
- c Positive vertical shift
- d Negative horizontal shift
- e Negative vertical shift

Design profile shift

A shift can be applied to the design profile. The shift is applied perpendicularly to the design profile at any point along the design profile.

A positive shift will increase the size of the profile, a negative shift will decrease the size of the profile.

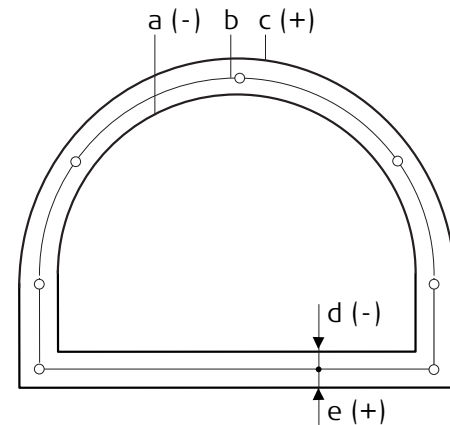

- a Design profile with negative shift
- b Original design profile
- c Design profile with positive shift
- d Negative shift
- e Positive shift

Description

A road surface can be thought of three different types of design elements:

- the horizontal alignment
- the vertical alignment
- the cross section

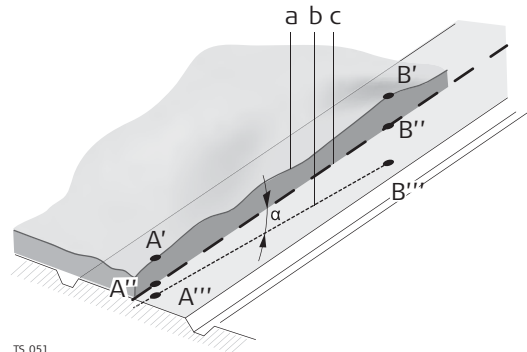
Basic concepts

TS_051

- a - Natural surface.
- b - The vertical alignment.
- c - The horizontal alignment.
- A''/B'' - Points on horizontal alignment
- A'/B' - Points on real surface
- A'''/B''' - Points on vertical alignment

Any point A in a project has ENH coordinates in a determined coordinate system. Each point has three different positions:

- A' - Point on real surface
- A'' - Point on horizontal alignment
- A''' - Point on vertical alignment

By adding a second point B to the project an alignment is defined. The alignment can be thought in three ways:

- Horizontal alignment (A''-B'')
- Projection of the horizontal alignment onto the real surface (A'-B')
- Vertical alignment (A'''-B''')

The angle between the horizontal and the vertical alignment is the grade (α).

Geometric elements

A road design is fitted to a base plan or map using the three basic geometric elements:

- Straight
- Curve
- Spiral



Refer to "I Glossary" for a definition of the terms.

44.2 Starting Alignment Editor

44.2.1 Accessing Alignment Editor

Access

Select **Leica Captivate - Home: Alignment editor**.

Alignment Editor

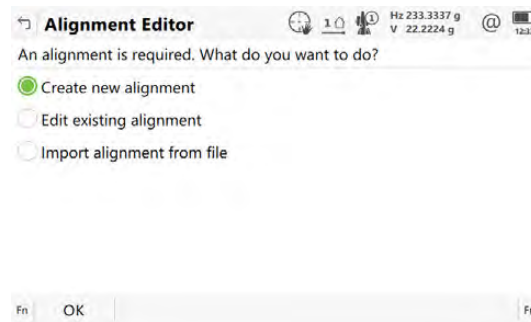

Key	Description
OK	To select the highlighted option and to continue with the subsequent panel.
Fn Settings	To configure the app. Refer to "44.3 Configuring Alignment Editor".

Next step

Select an option and press **OK**.

44.2.2 Creating a New Alignment

Access

Select **Create new alignment** in **Alignment Editor** and press **OK**.

New Alignment

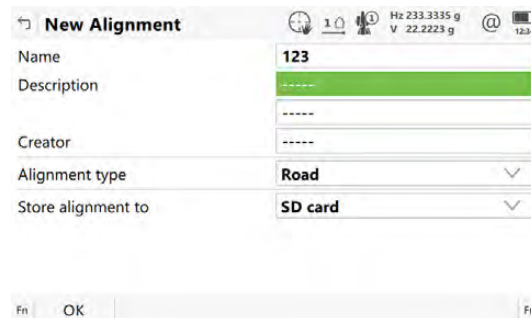

Key	Description
OK	To accept the panel entries and continue.
Fn Settings	To configure the app. Refer to "44.3 Configuring Alignment Editor".

Description of fields

Field	Option	Description
Name	Editable field	The name of the new raw alignment.

Field	Option	Description
Description	Editable field	Optional description of the new raw alignment.
Creator	Editable field	Optional description of the creator of this alignment.
Alignment type	Selectable list	Defines if the alignment is for roads or rails.
Store alignment to	Selectable list	The device on which the new raw alignment is stored. Depending on the inserted data storage devices, this field may be a display only field.

Next step

Press **OK** to access the **Alignment Editor Menu**. Refer to "44.2.5 Alignment Editor Menu".

44.2.3

Modifying an Existing Alignment

Access

Select **Edit existing alignment** in **Alignment Editor** and press **OK**.

Choose Alignment

Description of fields

Field	Option	Description
Alignment name	Selectable list	All existing raw alignments currently stored in the \Data\XML folder with the file extension *.xml.
Alignment type	Selectable list	Defines if the alignment is for roads or rails.

Next step

Highlight the **Alignment name** field and press **ENTER**.

Alignments



Key	Description
OK	To select the highlighted raw alignment and continue.
New	To create a new raw alignment. Refer to "44.2.2 Creating a New Alignment".
Edit	To edit the name and description of an existing raw alignment.

Key	Description
Delete	To delete an existing raw alignment.
USB, Internal or SD card	To change between viewing jobs stored on another data storage device or internal memory.
Fn Settings	To configure the app. Refer to "44.3 Configuring Alignment Editor".
Fn Backup	To restore a raw alignment file with the extension *.xmb currently stored in the \DataXML folder.

Next step

Press **OK** to select the highlighted raw alignment and return to the **Choose Alignment** panel.

Press **OK** to access the **Alignment Editor Menu**. Refer to "44.2.5 Alignment Editor Menu".

44.2.4

Importing Alignment Data

Access step-by-step

1. Select **Import alignment from file** in **Alignment Editor** and press **OK**.
2. Create a new alignment in the **New Alignment** panel. Refer to "44.2.2 Creating a New Alignment".
3. Press **OK**.

Import Line

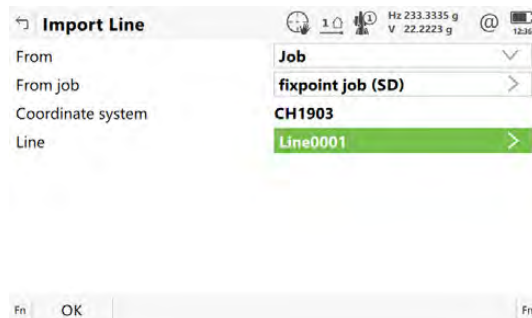

Key	Description
OK	To import the selected alignment data to active raw alignment.
Fn Settings	To configure the app. Refer to "44.3 Configuring Alignment Editor".

Description of fields

Field	Option	Description
From job	Job	To import lines from the selected job.
	Road design	To import lines from an existing Road job.
	Road+ (GSI format)	To import GSI alignment data.

Field	Option	Description
	Rail design	To import lines from an existing Rail job.
From job	Selectable list	All jobs are available for selection. Available for Job , Road design and Rail design .
Coordinate system	Display only	The coordinate system currently attached to the selected Job , Road design or Rail design .
Line	Selectable list	Line element from the selected job. Available for Job .
Alignment	Selectable list	Line from the selected Road job. The line must be stored in the \dbx folder of the data storage device to be selectable. Available for Road design and Rail design .
Alignment (.aln) file	Selectable list	Horizontal alignment file in GSI format. The GSI alignment file must be stored in the \GSI folder of the data storage device to be selectable. Available for Road+ (GSI format) .
Vertical (.prf) file	Selectable list	Vertical alignment file in GSI format. The GSI alignment file must be stored in the \GSI folder of the data storage device to be selectable. Available for Road+ (GSI format) .

Next step

OK imports the selected alignment data and accesses the **Alignment Editor Menu**. Refer to "44.2.5 Alignment Editor Menu".

44.2.5

Alignment Editor Menu

Access

This panel is always accessed after successfully creating, editing or importing an alignment file from the **Alignment Editor** panel.

Alignment Editor Menu

Description of options

Option	Description
Edit horizontal alignment	Depending on the setting for Use PI instead of element for horizontal alignment definition in Settings, Advanced page: <ul style="list-style-type: none"> To create, edit and delete elements of a horizontal alignment. Refer to "44.4 Edit Horizontal Alignments Using Elements". To create, edit and delete PIs of a horizontal alignment. Refer to "44.5 Edit Horizontal Alignments Using PIs".
Edit vertical alignment	Depending on the setting for Use PVI instead of element for vertical alignment definition in Settings, Advanced page: <ul style="list-style-type: none"> To create, edit and delete elements of a vertical alignment. Refer to "44.6 Edit Vertical Alignments Using Elements".

Option	Description
	<ul style="list-style-type: none"> To create, edit and delete PVI's of a vertical alignment. Refer to "44.7 Edit Vertical Alignments Using PIs".
Edit cross section templates	To create, edit and delete cross section templates. Refer to "44.8 Edit Cross Section Templates". Only available for road jobs.
Edit cross section assignmt	To create, edit and delete cross section assignments. Refer to "44.9 Edit Cross Section Assignments". Only available for road jobs.
Edit chain-age equation	To create, edit and delete chainage equations. Refer to "44.10 Edit Chainage Equation".
Convert to job	To convert existing LandXML alignments to a job. Refer to "44.11 Convert to job".

To be able to convert alignments to a job, at least a horizontal alignment must exist.

44.3

Configuring Alignment Editor

Access

Select **Leica Captivate - Home: Alignment editor**. Press **Fn Settings**.

Settings, Quality control page

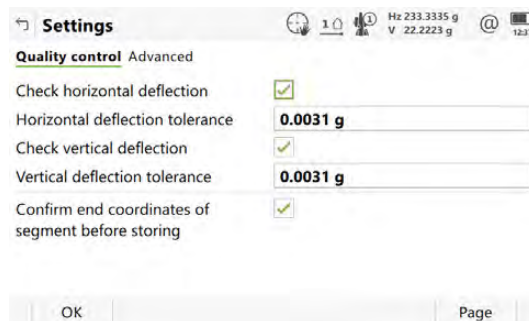

Key	Description
OK	To accept the panel entries and continue.
Page	To change to another page on this panel.
Fn About	To display information about the program name, the version number, the date of the version, the copyright and the article number.

Description of fields

Field	Option	Description
Check horizontal deflection	Check box	Possibility to do a deflection check for the horizontal alignment.

Field	Option	Description
Horizontal deflection tolerance	Editable field	The deflection tolerance for horizontal alignments. The tolerance value used for determining deflection errors. A deflection error occurs when the beginning curve tangent of an element does not match the ending tangent of the previous element. If the current error in deflection is greater than this value, the error is reported.
Check vertical deflection	Check box	Possibility to do a deflection check for the vertical alignment.
Vertical deflection tolerance	Editable field	The deflection tolerance for vertical alignments.
Confirm end coordinates of segment before storing	Check box	If this box is checked, then each time a new alignment element has been entered, a confirmation message displays the end coordinates for confirmation.

Next step

Page changes to the **Advanced** page.

Settings, Advanced page

Description of fields

Field	Option	Description
Vertical parabola definition		Parameter defining the parabola.
	Parameter p K factor	K factor = Parameter p/100.
Use PI instead of element for horizontal alignment definition	Check box	When this box is not checked, elements such as straights, curves and parabolas define the horizontal alignment.
		<p>When this box is checked, the horizontal alignment is defined by Points of Intersection. PIs are tangent or geometrical points.</p> <ul style="list-style-type: none"> Horizontal alignments are defined by the coordinates of the PI and, for circular curves, the curve radius. Horizontal transitions are defined by coordinate of PI, the circular curve radius plus tangent length in and tangent length out.

Field	Option	Description
Use PVI instead of element for vertical alignment definition	Check box	<p>When this box is not checked, elements such as straights, curves and parabolas define the vertical alignment.</p> <p>When this box is checked, the vertical alignment is defined by Points of Vertical Intersection. PVIs are tangent or geometrical points.</p> <ul style="list-style-type: none"> Vertical alignments with symmetrical curves are defined by the PVI chainage, the elevation of PVI and the total length of curve, where the tangent length is half the total length of the VC. Vertical Alignments with non-symmetrical curves are defined by the PVI chainage, the elevation of the PVI and both tangent lengths.

44.4

Edit Horizontal Alignments Using Elements

44.4.1

Overview

Description

Allows creating, editing and deleting of the following elements:

- Start Point
- Straight (Tangent)
- Curve
- Clothoid
- Cubic Parabola
- Partial Bloss

as well as checking the horizontal alignment.

Access

In **Alignment Editor Menu** highlight **Edit horizontal alignment**. Press **OK**.



Use PI instead of element for horizontal alignment definition must be unchecked in **Measure Settings, Advanced** page.

Horizontal Alignment, Elements page

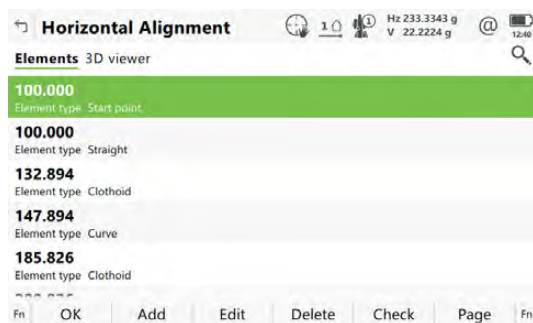

Key	Description
OK	To accept the panel entries and return to the Alignment Editor Menu .
Add	To add a new horizontal element after the highlighted element.
Edit	To edit the highlighted element of the horizontal alignment.
Delete	To delete the highlighted element of the horizontal alignment. Either all following elements or only the next element can be adjusted.
Check	To check the horizontal alignment.
Page	To change to another page on this panel.
Fn Settings	To configure the app. Refer to "44.3 Configuring Alignment Editor".

44.4.2

Editing the Start Point

Access

In **Horizontal Alignment**, highlight the start point and press **Edit**.

Horizontal Start Point

Horizontal Start Point

Easting: -19846.790 m

Northing: 5301045.974 m

Start chainage: 100.000 m

Fn OK Get point Meas app Fn

Key	Description
OK	To accept the panel entries and continue.
Get point	To apply coordinates or heights from an existing point in the job.
Meas app	To go to Measure and measure a point.
Fn Settings	To configure the app. Refer to "44.3 Configuring Alignment Editor".
Fn Reset	To reset all panel entries.

Description of fields

Field	Option	Description
Easting	Editable field	Easting of the start point of the horizontal alignment.
Northing	Editable field	Northing of the start point of the horizontal alignment.
Start chainage	Editable field	Start chainage of the horizontal alignment.

Access

In **Horizontal Alignment, Elements** page, highlight the start point, or an element if one exists, and press **Add** or **Edit**.



Elements can be added after the start point and either before or after other elements.



Creating and editing an alignment element are similar processes. For simplicity, only the creation of an alignment element is explained and differences are clearly outlined.

Add Horizontal Element**Description of fields**

Field	Option	Description
Element type	Straight	To insert/edit a straight to/in a horizontal alignment.
	Curve	To insert/edit a curve to/in a horizontal alignment.
	Spiral	To insert/edit a clothoid to/in a horizontal alignment.
	Cubic parabola	To insert/edit a cubic parabola to/in a horizontal alignment.
	Bloss	To insert/edit a blossom curve to/in a horizontal alignment.

The options available for the field **Method** depend on the **Element type** selected.

For **Element type: Straight**

Field	Option	Description
Method	Azimuth & length	Using the azimuth and the length of the straight.
	Azimuth & end chainage	Using the azimuth and the end chainage of the straight.
	End coordinates	Using the end coordinates of the straight.

For **Element type: Curve**

Field	Option	Description
Method	Radius & length	Using the radius of the curve and its length.
	Radius & deflection angle	Using the radius and the delta angle of the curve.
	Radius & end chainage	Using the radius of the curve and the end chainage.

Field	Option	Description
	Radius & end coordinates	Using the radius and the end coordinates of the curve.
	Centre point & end coords	Using the coordinates of the centre point and the end point of the curve.
	3 points	Using three points.

For **Element type: Spiral**

Field	Option	Description
Method	Radius & length	Using the radius of the clothoid and its length.
	Radius & end chainage	Using the radius of the clothoid and the end chainage.
	Parameter & length	Using the parameter A and the length of the connecting curve.
	Parameter & end chainage	Using the parameter A and the end chainage of the spiral.
	Radius & parameter	Using the parameter A and the radius.

For **Element type: Cubic parabola**

Field	Option	Description
Method	Radius & length	Using the radius of the cubic parabola and its length.
	Radius & end chainage	Using the radius of the cubic parabola and the end chainage.

For **Element type: Bloss**

Field	Option	Description
Method	Radius & length	Using the radius of the connecting curve and its length.
	Radius & end chainage	Using the radius of the connecting curve and its end chainage.
	Radius, length & end coords	Using the radius, length and end coordinates of the blossom curve.

Next step

OK to access the next panel.

Horizontal Straight/
Horizontal Curve/
Horizontal Clothoid/
Horizontal Cubic
Parabola/
Horizontal Bloss,
Input page

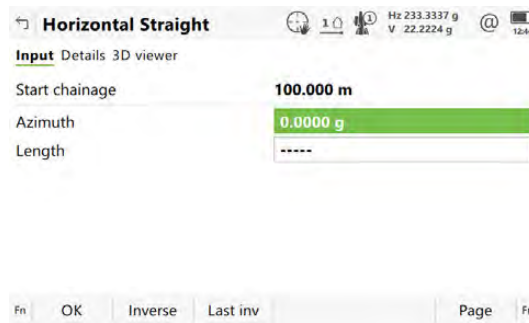

Key	Description
OK	To accept the panel entries and continue.
Inverse	To calculate the distance and angle between two points from the job.
Last inv	To select values from the last inverse calculations.
Get point	To apply coordinates or heights from an existing point in the job. Available when coordinates must be typed in.
Meas app	To go to Measure and measure a point. Available when coordinates must be typed in.
Page	To change to another page on this panel.
Fn Settings	To configure the Alignment editor app. Refer to "4.3 Configuring Alignment Editor".
Fn Reset	To reset all panel entries.

Description of fields

Field	Option	Description
Start chainage	Display only	The end chainage of the start point/previous element is automatically used and cannot be edited.

The other fields and options available depend on the **Method** and **Element type** selected in **Add Horizontal Element**.

For **Element type: Straight**

Field	Option	Description
Azimuth	Editable field	The azimuth displayed is from the previous element. Another value can be entered manually. Available for Method:Azimuth & length or Method:Azimuth & end chainage .
End chainage	Editable field	Chainage at the end of the element. Available for Method:Azimuth & end chainage .
End easting	Editable field	Easting for the end chainage. Available for Method:End coordinates .
End northing	Editable field	Northing for the end chainage. Available for Method:End coordinates .

Field	Option	Description
Length	Editable field	Length of the straight element. Available for Method:Azimuth & length .

For **Element type: Curve**

Field	Option	Description
Start azimuth	Editable field	The azimuth of the tangent in the start point. This azimuth is used from the previous element. The value can be edited. Available for Method:Radius & length , Method:Radius & deflection angle or Method:Radius & end chainage .
CP easting	Editable field	Easting of the centre point of the curve. Available for Method:Centre point & end coords .
CP northing	Editable field	Northing of the centre point of the curve. Available for Method:Centre point & end coords .
Curve direction	Right or Left	The direction of the curve when looking in the direction of increasing chainage. Available for Method:Radius & length , Method:Radius & deflection angle , Method:Radius & end chainage or Method:Radius & end coordinates .
Radius	Editable field	Radius of the curve. The signs are set by the system depending on the curve direction defined in Curve direction . Available for Method:Radius & length , Method:Radius & deflection angle , Method:Radius & end chainage or Method:Radius & end coordinates .
Deflection angle	Editable field	The deflection angle. Available for Method:Radius & deflection angle .
Length	Editable field	Length from the start to the end point of the curve. Available for Method:Radius & length .
End chainage	Editable field	The end chainage of the curve element can be typed in. Available for Method:Radius & end chainage .
Int easting	Editable field	Easting of the intermediate point of the 3-pt-arc. Available for Method:3 points .
Int northing	Editable field	Northing of the intermediate point of the 3-pt-arc. Available for Method:3 points .
End easting	Editable field	Easting for the end chainage. Available for Method:Radius & end coordinates , Method:Centre point & end coords and Method:3 points .

Field	Option	Description
End northing	Editable field	Northing for the end chainage. Available for Method:Radius & end coordinates , Method:Centre point & end coords and Method:3 points .

For **Element type: Spiral**

Field	Option	Description
Start azimuth	Editable field	The azimuth of the tangent in the start point. This azimuth is used from the previous element. The value can be edited.
Spiral direction	Right or Left	The direction of the clothoid looking in the direction of increasing chainage.
Spiral in/out	Spiral in Spiral out	For transition from tangent to curve. For transition from curve to tangent.
Radius	Editable field	Radius of the clothoid. Available for Method:Radius & length , Method:Radius & end chainage and Method:Radius & parameter .
Parameter A	Editable field	The parameter A defining the clothoid. Available for Method:Parameter & end chainage , Method:Parameter & length and Method:Radius & parameter .
Length	Editable field	Length of the clothoid element. Available for Method:Parameter & length and Method:Radius & length .
Start radius	Editable field	The entry radius of the spiral. The signs are set by the system depending on the spiral direction defined in Spiral direction . Available for Method:Radius & length and Method:Radius & end chainage when Use partial spiral is checked.
End radius	Editable field	The exit radius of the spiral. The signs are set by the system depending on the spiral direction defined in Spiral direction . Available for Method:Radius & length and Method:Radius & end chainage when Use partial spiral is checked.
End chainage	Editable field	The end chainage of the clothoid can be typed in. Available for Method:Radius & end chainage and Method:Parameter & end chainage .
Use partial spiral	Check box	To create a partial clothoid. Available for Method:Radius & length and Method:Radius & end chainage .

For **Element type: Cubic parabola**

Field	Option	Description
Start azimuth	Editable field	The azimuth of the tangent in the start point. This azimuth is used from the previous element. The value can be edited.
Spiral direction	Right or Left	The direction of the cubic parabola looking in the direction of increasing chainage.
Spiral in/out	Spiral in Spiral out	For a transition from tangent to curve. For a transition from curve to tangent.
Radius	Editable field	Radius of the cubic parabola.
Start radius	Editable field	The entry radius of the spiral. The signs are set by the system depending on the spiral direction defined in Spiral direction . Available when Use partial spiral is checked.
End radius	Editable field	The exit radius of the spiral. The signs are set by the system depending on the spiral direction defined in Spiral direction . Available when Use partial spiral is checked.
Length	Editable field	Length of the cubic parabola element. Available for Method:Radius & length .
End chainage	Editable field	The end chainage of the cubic parabola element can be typed in. Available for Method:Radius & end chainage .
Use partial spiral	Check box	To create partial cubic parabolas.

For **Element type: Bloss**

Field	Option	Description
Start azimuth	Editable field	The azimuth of the tangent in the start point. This azimuth is used from the previous element. The value can be edited.
Spiral direction	Right or Left	The direction of the blossom looking in the direction of increasing chainage.
Spiral in/out	Spiral in Spiral out	For a transition from tangent to curve. For a transition from curve to tangent.
Radius	Editable field	Radius of the blossom.
Start radius	Editable field	The entry radius of the spiral. The signs are set by the system depending on the spiral direction defined in Spiral direction . Available for Method:Radius, length & end coords .
End radius	Editable field	The exit radius of the spiral. The signs are set by the system depending on the spiral direction defined in Spiral direction . Available for Method:Radius, length & end coords .

Field	Option	Description
Length	Editable field	Length of the blossom curve element. Available for Method:Radius & length and Method:Radius, length & end coords.
End chainage	Editable field	The end chainage of the blossom curve element can be typed in. Available for Method:Radius & end chainage.
End easting	Editable field	Easting for the end chainage. Available for Method:Radius, length & end coords.
End northing	Editable field	Northing for the end chainage. Available for Method:Radius, length & end coords.

Next step

Page changes to the **Details** page, where all entered and calculated elements are displayed.

44.5

Edit Horizontal Alignments Using PIs

44.5.1

Overview

Description

Allows creating, editing and deleting PIs by chainage, easting and northing.

Access

In **Alignment Editor Menu** highlight **Edit horizontal alignment**. Press **OK**.



Use PI instead of element for horizontal alignment definition must be checked in **Measure Settings, Advanced** page.

Horizontal Alignment, PI page

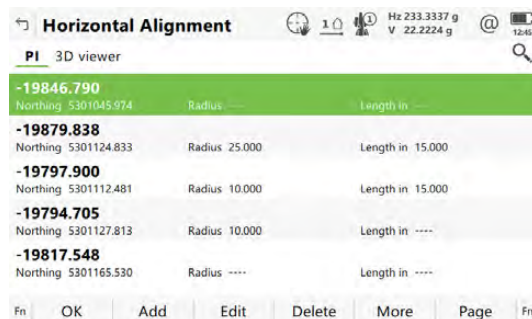

Key	Description
OK	To accept the panel entries and return to the Alignment Editor Menu .
Add	To add a new horizontal PI after the highlighted PI. The chainage values must be added in the correct order.
Edit	To edit the highlighted PI of the horizontal alignment.
Delete	To delete the highlighted PI of the horizontal alignment. Either all following elements or only the next element can be adjusted.

Key	Description
More	To display information about the length in/out and the parameter in/out.

44.5.2

Inserting/Editing a PI in a Horizontal Alignment

Access

In **Horizontal Alignment, PI** page, highlight a PI and press **Add** or **Edit**.



A PI can also be selected on the **3D viewer** page.



Elements are added after the highlighted PI.



Creating and editing an alignment PI are similar processes. For simplicity, only the creation of an alignment PI is explained and differences are clearly outlined.

Add PI

Key	Description
OK	To accept the panel entries and return to the Alignment Editor Menu .
Get point	To apply coordinates from an existing point in the job. Available when Easting or Northing is highlighted.
Meas app	To go to Measure and measure a point. Available when Easting or Northing is highlighted.
Inverse	To calculate the values for the distance and the offset from two existing points. Available when Radius , Length in , Length out , Parameter in or Parameter out is highlighted.
Last inv	To recall previous results from COGO inverse calculations. Available when Radius , Length in , Length out , Parameter in or Parameter out is highlighted.
Page	To change to another page on this panel.
Fn Settings	To configure the Alignment editor app. Refer to "44.3 Configuring Alignment Editor".
Fn Reset	To reset all panel entries.

Description of fields

Field	Option	Description
Easting and Northing	Editable field	The coordinates of the PI.

Field	Option	Description
Element type at PI	None	No element is defined at the PI.
	Curve	A curve is defined at the PI.
	Spiral	A spiral is defined at the PI.
	Spiral - curve	Spiral - curve is defined at the PI.
	Curve - spiral	Curve - spiral is defined at the PI.
	Spiral spiral	Two spirals are defined at the PI.
	Spiral - curve - spiral	Spiral - curve - spiral is defined at the PI.

The other fields on the panel depend on the **Element type at PI** selected.

For **Element type at PI: Curve**

Field	Option	Description
Radius	Editable field	Using the radius of the curve.

For **Element type at PI: Spiral**

Field	Option	Description
Spiral type	Clothoid, Cubic parabola or Bloss	Bloss is available for Rail jobs only.
Spiral in/out	Selectable list	The type of spiral.
Method	Radius & lengths	Available for Spiral type: Clothoid . Using the radius of the clothoid and its length.
	Radius & parameters	Using the radius of the clothoid and its parameters.
	Radius	Editable field
Radius in and Radius out	Editable field	The radius of the partial spiral for a clothoid or parabola. Available when Use partial spiral is checked.
Length in and Length out	Editable field	The lengths of the clothoid, parabola or blossom.
Parameter in and Parameter out	Editable field	Depending on the setting, the parameters P or factors K of the clothoid. Available for Spiral type: Clothoid with Method: Radius & parameters .

Field	Option	Description
Use partial spiral	Check box	To create a partial clothoid. Available for Spiral type: Clothoid and Spiral type: Cubic parabola .

For **Element type at PI: Spiral - curve** and **Element type at PI: Curve - spiral**

Field	Option	Description
Method		Available for Spiral type: Clothoid .
	Radius & lengths	Using the radius of the clothoid and its length.
	Radius & parameters	Using the radius of the clothoid and its parameters.
Radius	Editable field	The radius of the curve.
Length in	Editable field	The lengths of the connecting curve.
Parameter in	Editable field	Depending on the setting, the parameters P or factors K of the clothoid. Available for Spiral type: Clothoid with Method: Radius & parameters .

For **Element type at PI: Spiral spiral** and **Element type at PI: Spiral - curve - spiral**

Field	Option	Description
Method		Available for Spiral type: Clothoid .
	Radius & lengths	Using the radius of the clothoid and its length.
	Radius & parameters	Using the radius of the clothoid and its parameters.
Radius	Editable field	The radius of the curve.
Length in and Length out	Editable field	The lengths of the connecting curve.
Parameter in and Parameter out	Editable field	Depending on the setting, the parameters P or factors K of the clothoid. Available for Spiral type: Clothoid with Method: Radius & parameters .

Next step

OK to access the next panel.

44.6

Edit Vertical Alignments Using Elements

44.6.1

Overview

Description

Allows creating, editing and deleting of the following elements:

- Start Point
- Straight (Tangent)
- Parabola
- Asymmetric parabola
- Curve

as well as checking the vertical alignment.

Throughout the whole component height and elevation is used for local orthometric height. If no local orthometric height is available, the local ellipsoidal height is used instead.

Access

In **Alignment Editor Menu** highlight **Edit vertical alignment**. Press **OK**.



Use PVI instead of element for vertical alignment definition must be unchecked in **Measure Settings, Advanced** page.

Vertical Alignment, Elements page

The available keys are identical to the keys in **Horizontal Alignment**. Refer to the paragraph "Horizontal Alignment, Elements page".

44.6.2

Editing the Start Point

Access

In **Vertical Alignment**, highlight the start point and press **Edit**.

Vertical Start Point

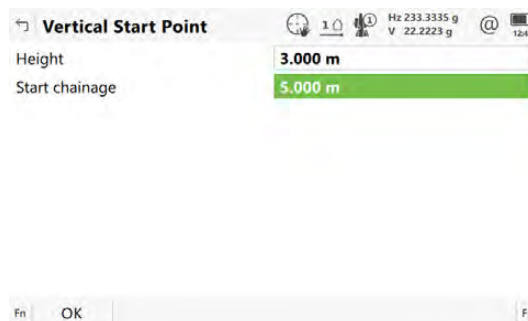

Key	Description
OK	To accept the panel entries and continue.
Get point	To apply heights from an existing point in the job.
Meas app	To go to Measure and measure a point.
Fn Settings	To configure the app. Refer to "44.3 Configuring Alignment Editor".
Fn Reset	To reset all panel entries.

Description of fields

Field	Option	Description
Height	Editable field	Elevation at the start chainage of the vertical alignment.
Start chainage	Editable field	Start chainage of the vertical alignment.

Access

In **Vertical Alignment, Elements** page, highlight the start point and press **Add** or **Edit**.



Creating and editing an alignment element are similar processes. For simplicity, only the creation of an alignment element is explained and differences are clearly outlined.



For grade units, the system settings are applied. Refer to "28.3 Regional" to change the system setting.

Add Vertical Element**Description of fields**

Field	Option	Description
Element type	Straight	To insert/edit a straight to/in a vertical alignment.
	Parabola	To insert/edit a quadratic parabola to/in a vertical alignment.
	Curve	To insert/edit a curve to/in a vertical alignment.

The options available for the field **Method** depend on the **Element type** selected.

For **Element type: Straight**

Field	Option	Description
Method	Length & end height	Using the length and the end elevation of the straight.
	End chainage & height	Using the end chainage and the elevation of the straight.
	Length & grade	Using the length and the grade of the straight.
	End chainage & grade	Using the end chainage and the grade of the straight.

For **Element type: Parabola**

Field	Option	Description
Method	Length & grades	Using the length and the grades of the parabola.
	End chainage & grades	Using the end chainage and the grades of the parabola.
	Parameter & end height	Using the parameter and the end elevation of the parabola.
	3 heights	Using three elevations at defined chainages of the parabola.

For **Element type: Curve**

Field	Option	Description
Method	Radius & length	Using the radius of the curve and its length.
	Radius & end chainage	Using the radius and the end chainage of the curve.
	Radius & grades	Using the radius and the grades of the curve.
	Length & grades	Using the length and the grades of the curve.
	End chainage & grades	Using start, intermediate and end elevation and chainage of the curve.

Next step

OK to access the next panel.

**Vertical Straight/
Vertical Parabola/
Vertical Curve,
Input page**

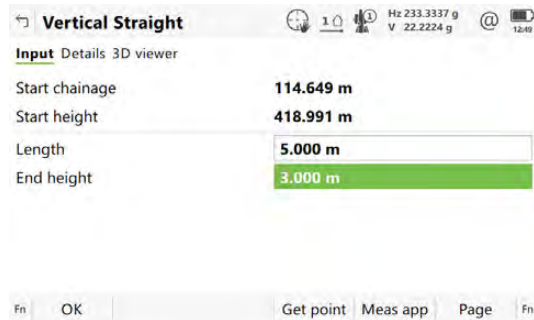

Key	Description
OK	To accept the panel entries and continue.
Inverse	To calculate the distance and angle between two points from the job.
Last inv	To select values from the last inverse calculations.
Get point	To apply coordinates or heights from an existing point in the job. Available when coordinates must be typed in.
Meas app	To go to Measure and measure a point. Available when elevation must be typed in.
Page	To change to another page on this panel.
Fn Settings	To configure the app. Refer to "44.3 Configuring Alignment Editor".
Fn Reset	To reset all panel entries.
Fn %/V:H/H:V	To switch between h:v , v:h and %(v/h x 100) for the grade unit.

Description of fields

Field	Option	Description
Start chainage	Display only	The end chainage of the previous element is automatically used and cannot be edited.
Start height	Display only	The end height of the previous element is automatically used and cannot be edited.

The other fields and options available depend on the **Method** and **Element type** selected in **Add Vertical Element**.

For **Element type: Straight**

Field	Option	Description
Length	Editable field	Length of the straight element as slope distance. Available for Method:Length & end height and Method:Length & grade .
End chainage	Editable field	Chainage at the end of the element. Available for Method:End chainage & height and Method:End chainage & grade .
End height	Editable field	Height at the end of the element. Type in manually or, alternatively, press Get point when the focus is on this line to select the height from an existing point in the job. Available for Method:Length & end height and Method:End chainage & height .
Grade	Editable field	The grade of the straight element. Positive inclines have positive values, negative inclines have negative values. Available for Method:Length & grade and Method:End chainage & grade .

For **Element type: Parabola**

Field	Option	Description
Curve type	Crest	The curve type is convex. Available for Method:Parameter & end height .
	Sag	The curve type is concave. Available for Method:Parameter & end height .
Parameter p or K factor	Editable field	Parameter of the parabola. Available for Method:Parameter & end height . The field name depends on the value chosen for the Vertical parabola definition in the Settings, Advanced page.
Length	Editable field	Length of the parabola as horizontal distance. Available for Method:Length & grades and Method:Parameter & end height .
Int chainage	Editable field	Chainage of the second elevation. Available for Method:3 heights .

Field	Option	Description
Int height	Editable field	Second elevation. Type in manually or press Get point when the focus is on this line to select the height from an existing point in the job. Available for Method:3 heights .
End chainage	Editable field	Chainage at the end of the element. Available for Method:End chainage & grades and Method:3 heights .
End height	Editable field	Height at the end of the element. Type in manually or, alternatively, press Get point when the focus is on this line to select the height from an existing point in the job. Available for Method:Parameter & end height and Method:3 heights .
Grade in	Editable field	The grade at the beginning of the parabola. Positive inclines have positive values, negative inclines have negative values. Available for parabolas with Method:Length & grades and Method:End chainage & grades .
Grade out	Editable field	The grade at the end of the parabola. Positive inclines have positive values, negative inclines have negative values. Available for Method:Length & grades and Method:End chainage & grades .

For **Element type: Curve**

Field	Option	Description
Curve type	Crest	The curve type is convex.
	Sag	The curve type is concave.
Radius	Editable field	Radius of the curve. Available for Method:Radius & length , Method:Radius & end chainage and Method:Radius & grades .
Length	Editable field	Length of the curve along the segment. Available for Method:Radius & length and Method:Length & grades .
End chainage	Editable field	Chainage at the end of the element. Available for Method:End chainage & grades and Method:Radius & end chainage .
End height	Editable field	Height at the end of the element. Type in manually or, alternatively, press Get point when the focus is on this line to select the height from an existing point in the job. Available for Method:Radius & length and Method:Radius & end chainage .

Field	Option	Description
Grade in	Editable field	The grade at the beginning of the parabola. Positive inclines have positive values, negative inclines have negative values. Available for Method:Radius & grades , Method:Length & grades and Method:End chainage & grades .
Grade out	Editable field	The grade at the end of the parabola. Positive inclines have positive values, negative inclines have negative values. Available for Method:Radius & grades , Method:Length & grades and Method:End chainage & grades .

Next step

Page changes to the **Details** page, where all entered and calculated elements are displayed. Press **Ch & ht** to query the elevation for a given chainage.

44.7

Edit Vertical Alignments Using PIs

44.7.1

Overview

Description

Allows creating, editing and deleting PIs by chainage, elevation and if required an element type (parabola, curve).

Access

In **Alignment Editor Menu** highlight **Edit vertical alignment**. Press **OK**.



Use PVI instead of element for vertical alignment definition must be unchecked in **Measure Settings, Advanced** page.

Vertical Alignment, PVI page

The available keys are identical to the keys in **Horizontal Alignment**. Refer to the paragraph "Add PVI".

44.7.2

Inserting/Editing a PVI in a Vertical Alignment

Access

In **Vertical Alignment, PVI** page, highlight a PVI and press **Add** or **Edit**.



Creating and editing an alignment PVI are similar processes. For simplicity, only the creation of an alignment PVI is explained and differences are clearly outlined.

Add PVI

Key	Description
OK	To accept the panel entries and return to the Alignment Editor Menu .
Get point	To apply heights from an existing point in the job. Available when Height is highlighted.
Meas app	To go to Measure and measure a point. Available when Height is highlighted.
Inverse	To calculate the values for the distance and the offset from two existing points. Available when Radius or Length is highlighted.
Last inv	To recall previous results from COGO inverse calculations. Available if Radius or Length is highlighted.
Page	To change to another page on this panel.
Fn Settings	To configure the app. Refer to "44.3 Configuring Alignment Editor".
Fn Reset	To reset all panel entries.

Description of fields

Field	Option	Description
Chainage	Editable field	The chainage of the vertical PVI.
Height	Editable field	The elevation of the vertical PVI.
Element type at PVI	None	No element is defined at the vertical PVI.
	Curve	A curve is defined at the vertical PVI.
	Parabola	A quadratic parabola is defined at the vertical PVI.

The other fields on the panel depend on the **Element type at PVI** selected.

For **Element type at PVI: Curve**

Field	Option	Description
Method	Length	To define the curve by its length.
	Radius	To define the curve by its radius.
Length	Editable field	The length of the curve.
Radius	Editable field	The radius of the curve.

For **Element type at PVI: Parabola**

Field	Option	Description
Method	Length	To define the parabola by its length.
	Parameter	To define the parabola by its parameter.
Length	Editable field	The length of the parabola.
Parameter p	Editable field	Depending on the setting, the parameters P or factors K of the parabola.

Next step

OK to access the next panel.

44.8

Edit Cross Section Templates

44.8.1

Overview

Description

Allows creating, editing, deleting and duplicating of cross section templates.

Access

In **Alignment Editor Menu** highlight **Edit cross section templates**. Press **OK**.

Templates



Key	Description
OK	To accept the panel entries and continue.
New	To create a cross section template.
Edit	To edit the highlighted cross section template.
Delete	To delete the highlighted cross section template.
Duplicate	To duplicate the highlighted template.
Page	To change to another page on this panel.

44.8.2

Creating/Editing a Cross Section Template

Access

In **Templates**

press **New** to create a new cross section template

OR

highlight an existing template and press **Edit**.



Creating and editing a cross section template are similar processes. For simplicity, only the creation of a cross section template is explained and differences are clearly outlined.

New Template, General page

New Template

General Layers 3D viewer

Template name: 55

Allow absolute heights for cross section definition:

Centre height: 0.000 m

Fn OK Page Fn

Key	Description
OK	To accept the panel entries and continue.
Page	To change to another page on this panel.
Fn Settings	To configure the app. Refer to "44.3 Configuring Alignment Editor".

Description of fields

Field	Option	Description
Template name	Editable field	Name of the cross section template to be created/edited.
Allow absolute heights for cross section definition	Check box	If this box is checked, in addition to relative to line input methods, absolute heights can also be entered to define cross section segments.
Centre height	Editable field	To be able to create segments using absolute heights, a centre height must be defined. Available if Allow absolute heights for cross section definition is checked.

Next step

Page changes to the **Layers** page where the layers of the template are listed.

44.8.3

Add/Edit a Layer

Access

In **New Template, Layers** page or when editing a template, press **New** or **Edit**.



Creating and editing a layer of a cross section template are similar processes. For simplicity, only the creation of a layer is explained and differences are clearly outlined.

New Layer, Segments page

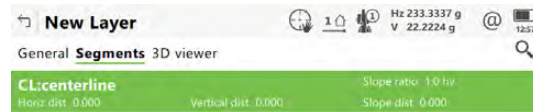

Fn OK Add Edit Delete More Page Fn

Key	Description
OK	To accept the panel entries and continue.
Add	To create and add a segment.
Edit	To edit the highlighted segment.
Delete	To delete the highlighted segment.
More	To switch between Horizontal offset to centreline , Slope distance , Horizontal distance in the second column and between Vertical offset to centreline , Slope ratio , Vertical distance in the metadata.
Page	To change to another page on this panel.
Fn Mirror	To mirror the entered segments to the other side of the cross section.

Description of metadata

Column	Description
-	The name of the segment.
Horizontal offset to centreline	Horizontal offset to the centreline of the segment.
Vertical offset to centreline	Vertical offset to the centreline of the segment.
Slope distance	Slope distance to the neighbouring vertex.
Slope ratio	Slope ratio of the segment.
Horizontal distance	Horizontal distance to the neighbouring vertex.
Vertical distance	Vertical distance to the neighbouring vertex.

Next step

Add to add a segment.

Add Segment, Input page

Add Segment

Input Details 3D viewer

Template name: 55

Layer name: centerline

Method: Horizontal distance & slo... ▼

Horizontal distance: -----

Slope ratio: -----

Fn OK % Page Fn

Key	Description
OK	To accept the panel entries and continue.
Inverse	Available when Horizontal distance , Horizontal offset to centreline or Slope distance is highlighted. To calculate the distance and angle between two points from the job.
Last inv	Available when Horizontal distance , Horizontal offset to centreline or Slope distance is highlighted. To select values from the last inverse calculations.
%/ V:H/ H:V	To switch between h:v , v:h and %(v/h x 100) for the slope ratio.
Page	To change to another page on this panel.
Fn Settings	To configure the app. Refer to "44.3 Configuring Alignment Editor".
Fn Reset	To reset all panel entries.

Description of fields

Field	Option	Description
Template name	Display only	Name of the cross section template to be edited.
Layer name	Display only	Name of the layer to be edited.
Method		Method to be used for defining the segment.
	Horizontal distance & slope	Using a horizontal distance and slope ratio to define the segment.
	Horiz & vertical distance	Using a horizontal distance and a vertical distance to define the segment.
	CL offsets	Using a horizontal and vertical offset in relation to the centreline.
	Slope distance & ratio	Using a slope distance and slope ratio to define the segment.
	Horiz distance & height	Using a horizontal and absolute height to define the segment. Only available for templates with Allow absolute heights for cross section definition enabled.

Field	Option	Description
	Offset & ht to centre-line	Using a horizontal offset in relation to the centreline and absolute height. Only available for templates with Allow absolute heights for cross section definition enabled.
Horizontal distance	Editable field	Horizontal distance of the segment. Available for Method: Horizontal distance & slope and Method: Horiz & vertical distance .
Vertical distance	Editable field	Vertical distance of the segment. Available for Method: Horiz & vertical distance .
Horizontal offset to centreline	Editable field	Horizontal centreline offset of the segment. Only available for Method: CL offsets .
Vertical offset to centreline	Editable field	Vertical centreline offset of the segment. Only available for Method: CL offsets .
Slope distance	Editable field	Slope distance of the segment. Only available for Method: Slope distance & ratio .
Slope ratio	Editable field	Slope ratio of the segment. Available for Method: Horizontal distance & slope and Method: Slope distance & ratio .

Next step

Page changes to the **Details** page, where all entered and calculated elements are displayed.

44.9

Edit Cross Section Assignments

44.9.1

Overview

Description

Allows the creation, editing and deleting of cross section assignments as well as checking the cross section assignments.

A cross section assignment defines from which chainage on a cross section template is to be used.

Access

In **Alignment Editor Menu** highlight **Edit cross section assignmt**. Press **OK**.

Cross Section Assignments



Key	Description
OK	To accept the panel entries and continue.

Key	Description
New	To create a cross section assignment.
Edit	To edit a cross section assignment.
Delete	To delete a cross section assignment.
Check	To check the cross section assignments.
Fn Settings	To configure the app. Refer to "44.3 Configuring Alignment Editor".

44.9.2

Creating/Editing a Cross Section Assignment

Access

In **Cross Section Assignments** press **New** or **Edit**.



Creating and editing a cross section assignment are similar processes. For simplicity, only the creation of a cross section assignment is explained and differences are clearly outlined.



Assigned cross section templates must contain the same number of vertices.

New Cross Section Assgmt

Key	Description
OK	To accept the panel entries and continue.
Start chng	To take the start chainage of the vertical alignment for Chainage .
End chng	To take the end chainage of the vertical alignment for Chainage .
Fn Settings	To configure the app. Refer to "44.3 Configuring Alignment Editor".

Description of fields

Field	Option	Description
Chainage	Editable field	The chainage to which the cross section template is assigned to. Type in or edit the value for Chainage. Alternatively press Start chng or End chng to apply the start or end chainage of the vertical alignment.

Field	Option	Description
Template name	Selectable list	The cross section template to be assigned to. All existing cross section templates currently stored to the alignment can be selected. Select an existing template from the list or create a template to be assigned to the Chainage .

44.10 Edit Chainage Equation

44.10.1 Overview

Description

Allows creating, editing and deleting of:

- Gaps
- Overlaps

Access

In **Alignment Editor Menu** highlight **Edit chainage equation**. Press **OK**.

Chainage Equation



Key	Description
OK	To accept the panel entries and continue.
New	To create a chainage equation.
Edit	To edit a chainage equation.
Delete	To delete a chainage equation.
Fn Settings	To configure the app. Refer to "44.3 Configuring Alignment Editor".

44.10.2 Creating/Editing a Chainage Equation

Access

In **Chainage Equation** press **New** or **Edit**.



Creating and editing a Chainage equation are similar processes. For simplicity, only the creation of a Chainage equation is explained and differences are clearly outlined.

New Chainage Equation

Description of fields

Field	Option	Description
Chainage back	Editable field	Chainage back. Type in or edit the value.

Field	Option	Description
Chainage ahead	Editable field	Chainage ahead. Type in or edit the value.

Next step

OK to create the chainage equation or to store the edited chainage equation.

44.11

Convert to job

Description



Allows the onboard conversion of existing LandXML alignments including horizontal alignment, vertical alignment, cross sections and chainage equations to a Roads job.

Access

In **Alignment Editor Menu** highlight **Convert to job**. Press **OK**.

Convert to Road Job/ Convert to Rail Job

Description of fields

Field	Option	Description
Convert alignment	Display only	Displays the modified or newly created alignment to be converted.
To road job	Selectable list	The Road job to which the alignment is converted. Create a job. Available if the Alignment type is set to Road in Choose Alignment .  If a new job with the same name as an existing job must be created, then the existing job must be deleted first.
To rail job	Selectable list	The Rail job to which the alignment is converted. Create a job. Available if the Alignment type is set to Rail in Choose Alignment .  If a new job with the same name as an existing job must be created, then the existing job must be deleted first.
Geometry to be converted		Defines the mode to be used for the conversion process.
	Horiz & vertical alignment	Only horizontal and vertical alignment is converted.
	Horizontal alignment only	Only horizontal alignment is converted.
	Horiz, vertical, cross section	Horizontal alignment, vertical alignment and cross sections are converted. Only available for road jobs.

Next step

Press **OK** to start the conversion.

Alignment Editor creates a report sheet during the conversion. The file LandXml2Dbx.log can be found in the \Data\XML folder on the data storage device.

After the successful conversion, press **OK** to return to the **Leica Captivate - Home** on the instrument.

45

Roads - Road

45.1

Creating a New Road Job

Description

There are two ways of creating road/rail jobs:

Typing them in manually by using the **Alignment editor** app.

OR

Converting data created in a design package.

Manually entered data

Data can be typed in and edited with **Alignment editor**. Refer to "44 Roads - Alignment Editor" for information on how to enter data manually.

Converted data

The **Import data** functionality in the job menu supports different formats like dxf, LandXml, MxGenio, Terramodel, Carlson.

The Design to Field component of Infinity offers converters from several road/rail design and CAD packages. Several design packages also include a built-in converter to Roads/Rail. As different design packages follow different philosophies in representation, creation and storage of data the conversion process differs slightly.

Infinity can be found on the Infinity DVD.

The latest version of the Design to Field importers can be found in the downloads section of:

- myWorld@Leica Geosystems
<https://myworld.leica-geosystems.com>

Job selection

Refer to "43.2.1 Accessing Roads Apps".

45.2

Defining the Work

45.2.1

Defining the Method and the Task

Access

Select **Leica Captivate - Home: Stake road** or **Check road**.

Task

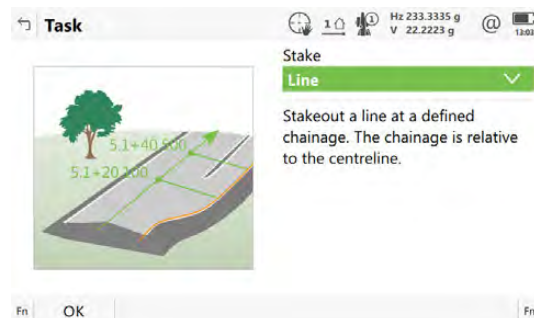

Key	Description
OK	To continue to the next panel.
Fn Settings	To configure the app. Refer to "43.3 Configuring Roads Apps".

Key	Description
Fn Method	To define what is shown in the selectable list for Stake .

Description of the methods

Method	Description
Line	To stake/check any type of line, for example a centreline or kerb. Chainage information is related to the centreline.
Local line	Like the previous method when staking/checking any line of a layer. The stake/check is always in relation to the chainage of the line itself and not the centreline of the layer.
Surface grade	To stake/check a surface grade defined by the road design. Two lines define the surface grade.
Manual slope	To stake/check a manually defined slope relative to an existing centreline. The slope is defined by one line and the slope direction with ratio. The stake/check is always in relation to the chainage of the line itself and not the centreline of the layer.
Local manual slope	To stake/check a manually defined slope relative to an existing hinge line. The slope is defined by one line and the slope direction with ratio.
Slope	To stake/check a slope defined by two lines of the 3D road design.
Crown	To stake/check a road crown defined by two surface grades and one common line. The information for both surface grades is displayed at the same time.
Layer	To stake/check a layer surface defined by the road design relative to the layer centreline.
DTM	To check a DTM surface. Available for Check road only.

The available methods depend on the selected job types (road or design job):



Available method	Road job only	Design job only	Road job, points & lines job	DTM job only
Line	✓	-	✓	-
Local line	✓	✓	✓	-
Surface grade	✓	-	-	-
Manual slope	✓	-	✓	-
Local manual slope	✓	✓	✓	-
Slope	✓	-	-	-
Crown	✓	-	-	-
Layer	✓	-	-	-
DTM	-	-	-	✓

Next step

OK accesses the **Define Task** panel.

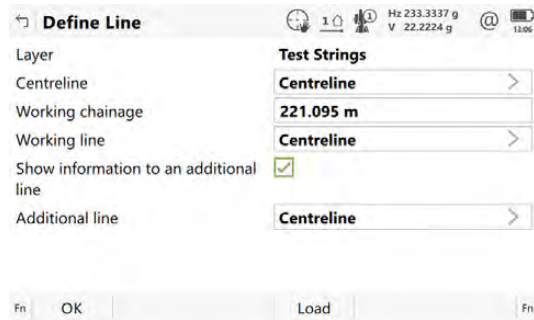
Define Task panel



Key	Description
OK	To continue to the next panel.
Slope	Available for Stake: Local manual slope . To define the slope parameters. Refer to "45.2.3 Advanced Slope Settings".
Shifts	To apply horizontal and vertical shifts to the selected element. Refer to "43.4 Working with Shifts".
Load	To load a task. Refer to "43.5 Tasks".
Save task	To save the settings as a task. Refer to "43.5 Tasks".
Page	To change, depending on the selected method, to Hinge offset and/or 3D viewer page.  Any line can be selected on the 3D viewer page.  Import dxf lines to a design job before using for Roads. Refer to "35.6 Context Menu".
Fn Settings	To configure the app. Refer to "43.3 Configuring Roads Apps".

The fields available depend on the selection for **Stake in Task**.

Description of fields

Common to all methods

Field	Option	Description
Layer	Display only or selectable list	The selected layer in the Road job.

For **Stake: Line**

Field	Option	Description
Working chainage	Editable field	The chainage for the stake/check survey. The chainage can range between the start chainage and the end chainage. The default is the setup point for TS and the current position for GS.

Field	Option	Description
Working line	Selectable list	To select a line at the Working chainage . Or select a line on the 3D viewer page. Refer to "45.2.2 Selecting a Line".
Show information to an additional line	Check box	When this box is checked, a second line can be selected. Allows chainage, offset and height difference information to be obtained from any other string of the layer, independent from those strings currently selected for the chosen method. For example: Staking a surface grade where the height information comes from the surface grade, but the chainage information comes from a string which is not the centreline of the current layer. For the additional line, an offset and a height difference can be defined on the  page.
Additional line	Selectable list	The lines available as second lines, independent of the Working chainage . Or select a line in 3D viewer.

For **Stake: Local line**

Field	Option	Description
Working line	Selectable list	To select a line at the Working chainage . Or select a line in 3D viewer.
Show information to an additional line	Check box	When this box is checked, a second line can be selected. Allows chainage, offset and height difference information to be obtained from any other string of the layer independent from those strings currently used. For example: Staking a surface grade where the height information comes from the surface grade but the chainage information comes from a string which is not the centreline of the current layer.
Additional line	Selectable list	The lines available as second lines, independent of the Working chainage . Or select a line in 3D viewer.

For **Stake: Surface grade**

Field	Option	Description
Working chainage	Editable field	The chainage for the stake/check survey. The chainage can range between the start chainage and the end chainage. The default is the setup point for TS and the current position for GS.

Field	Option	Description
Left line	Selectable list	The name of the left line defining the surface grade. Refer to "45.2.2 Selecting a Line".
Right line	Display only	The name of the right line defining the surface grade.
Reference line	Left line or Right line	To select one of the lines to be used as the reference line.
Show information to an additional line	Check box	When this box is checked, a second line can be selected. Allows chainage, offset and height difference information to be obtained from any other string of the layer independent from those strings currently used. For example: Staking a surface grade where the height information comes from the surface grade but the chainage information comes from a string which is not the centreline of the current layer.
Additional line	Selectable list	The lines available as second lines, independent of the Working chainage . Or select a line in 3D viewer.

For **Stake: Manual slope** and **Stake: Local manual slope**

Field	Option	Description
On the Slope page:		
Working chainage	Editable field	The chainage for the stake/check survey. The chainage can range between the start chainage and the end chainage of selected line.
Hinge line	Selectable list	To select the hinge point of the slope. Or select a line in 3D viewer.  For Manual slope , only lines from the Road job can be selected.

Field	Option	Description
Slope location	Left or Right	Defines if the slope is left or right of the hinge point.
<p style="text-align: center; font-size: small;">Road_079</p> <p style="text-align: center;"> a Hinge Point b Left, cut c Right, cut d Left, fill e Right, fill </p>		
Use cut and Use fill	Check box	When the box is checked, a cut/fill is used for the calculation. During the surveying process, the system calculates if it is a cut or a fill. Check only one box to work only with cut or fill.
Cut slope and Fill slope	Editable field	Defines the cut/fill ratio of the slope. The slope ratio format is defined as system setting in Regional, Slope page.
On the Hinge offset page:		
Apply hinge offsets	Check box	When this box is checked, a horizontal and vertical offset of the hinge point can be defined.
Offset	Editable field	The horizontal offset of the hinge point from the centreline/reference line.
Height offset type		The vertical offset type for the hinge point.
	Absolute	The only option available for 2D lines.
	Relative to line or Relative to DTM	Available for 3D lines.
	Relative to surface grade	Available for Stake: Manual slope . The manual slope is defined by: <ul style="list-style-type: none"> • Hinge offset relative to the selected hinge reference line • Hinge height, calculated by using the hinge offset on the selected surface grade (left or right selected surface grade, depending on Offset - or +)

Field	Option	Description
-------	--------	-------------

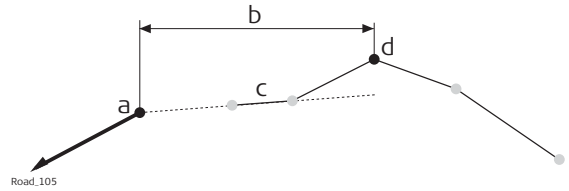

- a Hinge point of manual slope
- b Defined hinge offset (-)
- c Left surface grade of design
- d Selected hinge reference

Height	Editable field	The elevation of the hinge point (absolute height). Available for Height offset type: Absolute .
Height difference	Editable field	For Height offset type: Relative to line : A vertical offset for the hinge point using a height difference can be defined. For Height offset type: Relative to DTM : A height difference to the DTM height can be applied.

For Stake: Slope

Field	Option	Description
Working chainage	Editable field	The chainage for the stake/check survey. The chainage can range between the start chainage and the end chainage. The default is the setup point for TS and the current position for GS.
Left line	Selectable list	The name of the left line defining the slope.
Right line	Display only	The name of the right line defining the slope.
Reference line	Left line or Right line	To select one of the lines to be used as the reference line. The reference line is the hinge line.

For Stake: Crown

Field	Option	Description
Working chainage	Editable field	The chainage for the stake/check survey. The chainage can range between the start chainage and the end chainage. The default is the setup point for TS and the current position for GS.
Crown line	Selectable list	Line defining the middle line of the crown. Refer to "45.2.2 Selecting a Line".
Left line	Display only	The name of the line defining left line of the crown.
Right line	Display only	The name of the line defining right line of the crown.

Field	Option	Description
Reference line	Left line or Right line	To select one of the lines to be used as the reference line.
Show information to an additional line	Check box	When this box is checked, a second line can be selected. Allows chainage, offset and height difference information to be obtained from any other string of the layer independent from those strings currently used. For example: Staking a surface grade where the height information comes from the surface grade but the chainage information comes from a string which is not the centreline of the current layer.
Additional line	Selectable list	The lines available as second lines.

For **Stake: Layer**

Field	Option	Description
Layer	Selectable list	A list of all available layers of the selected Road job.
Centreline	Display only	Active centreline of the selected layer.
Extend end slopes	Check box	When this box is checked, the left most and right most end slopes of the design are extended.

For **Stake: DTM**, available for **Check road**

Field	Option	Description
DTM layer	Display only	A list of all DTM surfaces available in the selected DTM job.
Number of triangles	Display only	Number of triangles the selected DTM consists of.

Next step

OK to access the **Stake** or **Check** panel.

45.2.2

Selecting a Line

Access

In the Define panel, open a selectable list for a line, for example for **Working line** or **Left line**.



The selection of lines depends on:

- Availability of horizontal alignments
- Availability of vertical alignment information
- View (plan or cross section view)
- Working chainage defined or not
- Selected method

Lines

The panel can have several pages.

- **Lines** page, if a design job is selected.
- **Alignments** page (if road alignment is selected)
- **3D viewer** page

If no working chainage has been entered, the lists show all lines of the current layer. If a working chainage is available, all lines existing at that chainage are listed only.

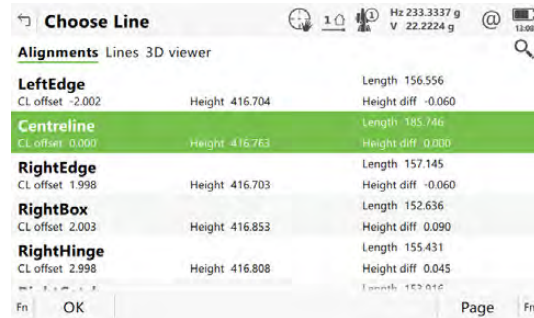

Key	Description
OK	To return to the previous panel.
More	On the Lines page: To display information about the codes if stored with any line, the start time, the end time of when the last point was added to the line and the length of the line. On the Alignments page: To display information about the absolute height or the height difference. Unavailable for local lines.
Page	To change to another page on this panel.

Description of metadata

Metadata	Description
-	The name of the line.
CL offset	The offset from the centreline. The format is defined as system setting in Regional .
Height	The absolute height of the line.
Height diff	The height difference to the centreline.



In addition to the list selection the required lines and slopes can also be selected in 3D viewer.

Lines can be selected in a graphical way by using the

- cross section view. The cross section view is available if a working chainage has been defined. The selected line (3D only) from the design job is also displayed. Unavailable for **Stake: Local manual slope**.
- planar view which is always available. The defined working chainage is displayed as a grey line. The size corresponds to the working corridor settings.

Click a line for selection.

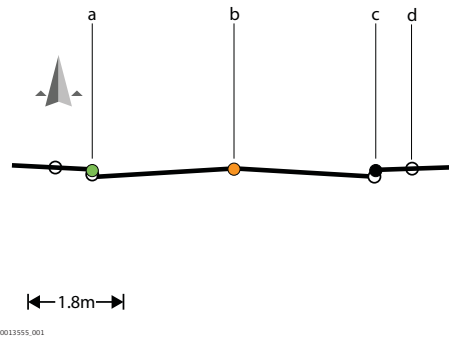

- a Centreline
- b Working line
- c Selected line
- d Stringlines with status **Use: No** are drawn as well, but they are not included in the profile

Colour coding

Selected line	Colour
Working line	Orange
Centreline	Green
Selected line	Thick black
Other stringline	No colour fill

45.2.3

Advanced Slope Settings

Access

Press **Slope** in the Define panel.

General slope stake-out

Description

This method involves a generic approach to slope stakeout for direct stakeout of the catch point. No special batter rails or reference point parameters are defined.

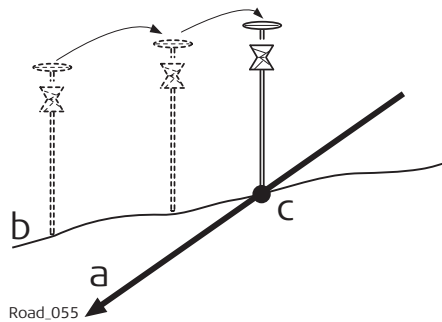

- a Slope to stake out
- b Natural surface
- c Catch point

Workflow

As the natural surface is unknown the catch point can only be staked out iteratively. If staking out on a horizontal natural surface, the values shown for **Difference in offset** indicate how far the catch point is away. If the natural surface is not horizontal, more iterations could be needed.

Slope Stakeout Settings

Key	Description
OK	To return to the Define panel.
Types	To define which slope stakeout types are shown and which are hidden.

Description of fields

Common to all types

Field	Option	Description
Use advanced slope stake-out	Check box	When this box is checked, slope stakeout settings are available.
Type	Reference point	Stakeout of a reference peg with a defined offset from the catch point. Refer to "Slope staking using Reference point".
	Batter rail vertical	Stakeout of batter rails using defined rail heights vertically above the batter. Refer to "Slope staking using Batter rail vertical or Batter rail perpendicular".
	Batter rail perpendicular	Stakeout of batter rails using defined rail heights perpendicularly above the batter. Refer to "Slope staking using Batter rail vertical or Batter rail perpendicular".
	Ref batter vertical	Stakeout of batter rails using defined rail heights vertically above the batter. The innermost peg/stake is offset at a defined horizontal distance from the catch point. Refer to "Slope staking using Ref batter vertical or Ref batter perpendicular".
	Ref batter perpendicular	Stakeout of batter rails using defined rail heights perpendicularly above the batter. The innermost peg/stake is offset at a defined horizontal distance from the catch point. Refer to "Slope staking using Ref batter vertical or Ref batter perpendicular".
	Ref point surface	Stakeout of a reference peg in the slope surface with a defined height difference to the hinge point. Slope values for the reference point cannot be entered. Refer to "Slope staking using Ref point surface".

For **Type: Reference point**

Field	Option	Description
Ref offset	Editable field	The defined offset of the reference point from the catch point.

For **Type: Batter rail vertical** and **Type: Batter rail perpendicular**

Field	Option	Description
Batter type	Cut or Fill	Defines the cut or fill rail.
Traveller height	Editable field	Depending on the selected Type , the vertical or perpendicular height of the rail top above the batter.

Field	Option	Description
Rail over ground	Editable field	The vertical height of the rail over the ground.

For **Type: Ref batter vertical** and **Type: Ref batter perpendicular**

Field	Option	Description
Ref offset	Editable field	The defined offset of the inner peg from the catch point.
Traveller height	Editable field	Depending on the selected Type , the vertical or perpendicular height of the rail above the batter.

For **Type: Ref point surface**

The only available fields are **Use advanced slope stakeout** and **Type**.

Next step

OK returns to the Define panel.

Slope staking using Reference point

Description

When staking out slopes using the reference point method, the catch point of the slope is marked with a reference peg using a defined offset. Grade checkers mark and control the grade of the slope.

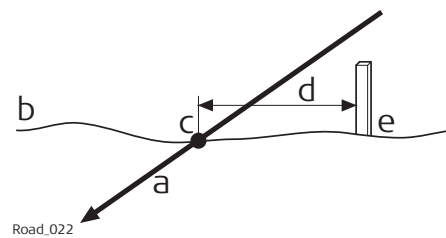

- a Slope to stake out
- b Natural surface
- c Catch point of the slope
- d Defined reference point offset
- e Reference peg

The reference point offset guarantees that all pegs are placed with the same horizontal offset to the catch point.

Workflow

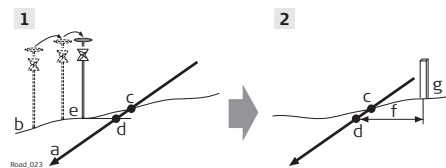

- a Slope to stake out
- b Natural surface
- c Real catch point
- d Projected catch point
- e Approximate staked out catch point after three iterations
- f Defined reference point offset
- g Reference peg

1. The first step when staking out is to find the catch point of the slope. As the natural surface is unknown, the process is iterative. As soon as the measured position (e) is close enough to the real catch point (c), it can be used as the approximate catch point. Based on this approximate catch point, the projected catch point (d) on the slope is calculated. No reference point offset and no traveller height are taken into account for this step. The projected catch point (d) is then used as a starting point for the stakeout of the reference peg (g).
2. The second step is to stake out the reference point relative to the projected catch point. Select **Place reference peg** from the toolbox. Values in **Stake Slope Reference Pt** guides the user to the position to place the peg. The defined reference point offset (f) is already taken into account. The catch point is marked indirectly using the reference peg. Values to be marked on the reference peg can be found on **Stake Slope Reference Pt, Info** page.

The closer the real catch point and the approximated stakeout catch point are, the closer the projected catch point gets to the real catch point.

Slope staking using Batter rail vertical or Batter rail perpendicular

Description

When staking out slopes with the **Batter rail vertical** or **Batter rail perpendicular** method, the grade of the slope is marked with a board. Using this method it is not necessary to stake out the catch point first.

For Batter rail vertical

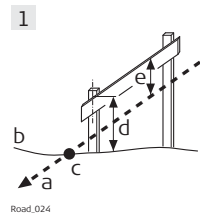

Road_024

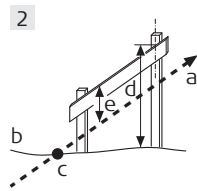

- 1 Batter rail for a cut
 - 2 Batter rail for a fill
- a Slope to stake out
 - b Natural surface
 - c Catch point of the slope
 - d Rail over ground
 - e Rail over batter, vertical

For Batter rail perpendicular

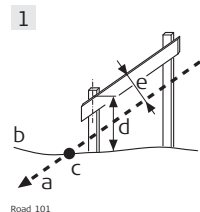

Road_101

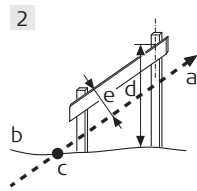

- 1 Batter rail for a cut
 - 2 Batter rail for a fill
- a Slope to stake out
 - b Natural surface
 - c Catch point of the slope
 - d Rail over ground
 - e Rail over batter, perpendicular

The defined rail over ground should guarantee that the rails are positioned as high as possible, to make them easier to use.

1. The first peg to stake out is always the peg closest to the hinge point.
Stake out the position of the first peg of the batter by using **Difference in offset** on the Stake/Check panel. The height of the rail over ground **Rail over ground** is taken into account for **Difference in offset**. This action means that when **Difference in offset** is equal to zero the first peg is in the correct position.

2. Place the pole on top of the first peg. The value for **Difference in height** indicates how far below the top of the batter has to be placed.

3. Stake out the second peg of the batter rail by using **Difference in chainage** and place the peg.

4. Place the pole on the position of the batter rail to be used as a reference for the slope values to mark on the batter rail. **Difference in height** should now read zero.
 All values shown under the **i** page are relative to the original slope.

Slope staking using Ref batter vertical or Ref batter perpendicular

Description

If batter rails with a constant distance from the inner peg to the catch point are required, this method is used.

For Ref batter vertical

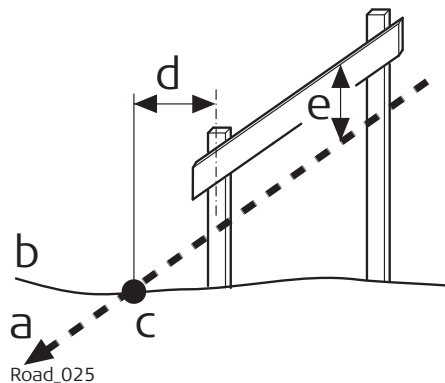

- a Slope to stake out
- b Natural surface
- c Catch point of the slope
- d Defined reference point offset
- e Height of the "traveller", vertical

For Ref batter perpendicular

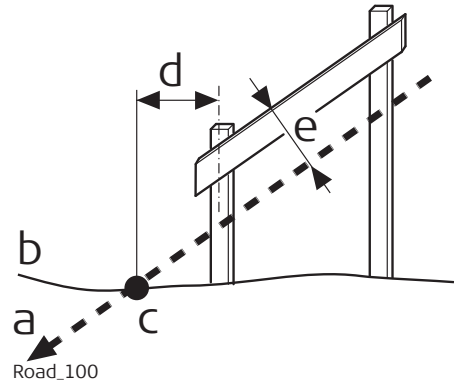



- a Slope to stake out
- b Natural surface
- c Catch point of the slope
- d Defined reference point offset
- e Height of the "traveller", perpendicular

Workflow



The first step is to stake out the catch point of the slope. The reference point offset and traveller height are not taken in account in this step. Based on this approximate catch point the projected catch point on the slope is calculated. The projected catch point is used as a starting point for the stakeout of the reference peg.

1. Stake out the position of the catch point by using **Difference in offset** and/or **Difference in height** on the Stake/Check panel. When **Difference in offset** and **Difference in height** are equal to zero, the catch point has been located.
2. **Fn Tools** to access the Tools panel. The measured position is used as the catch point for the stake out of the reference point.
3. Select **Place reference peg** to access the stakeout panel for the reference peg.
4. Stake out the reference point using **Difference in offset**. When **Difference in offset** is equal to zero the reference peg position has been found.
5. Place the pole on top of the reference peg. The value for **Difference in height** indicates how far below the top of the peg the batter has to be placed.
6. Place the pole on the position of the batter rail to be used as a reference for the slope values to mark on the batter rail. **Difference in height** should now read zero. All values shown under the  page are relative to the original slope.
7.  to return to **Stake Slope**. Stake out the next catch point from this panel.

Slope staking using Ref point surface

Description

When staking out slopes using the reference point surface method, the reference peg is staked out with a defined height difference to the hinge point.

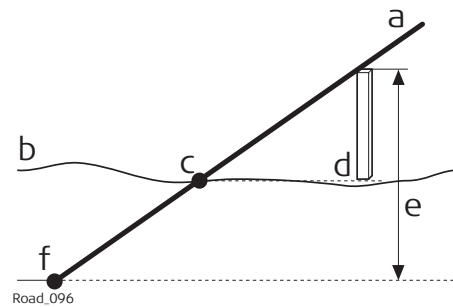

- a Slope to stake out
- b Natural surface
- c Catch point of the slope
- d Reference peg
- e Defined hinge height difference
- f Hinge point

Workflow

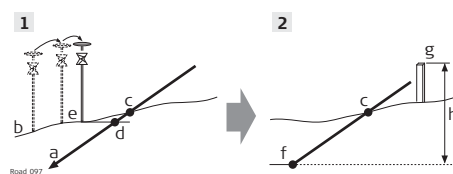

- a Slope to stake out
- b Natural surface
- c Real catch point
- d Projected catch point
- e Approximate staked out catch point after three iterations
- f Hinge point
- g Reference peg
- h Defined hinge height difference



The first step when staking out is to find the catch point of the slope. As the natural surface is unknown, the process is iterative. As soon as the measured position (e) is close enough to the real catch point (c), it can be used as the approximate catch point. Based on this approximate catch point, the projected catch point (d) on the slope is calculated.

The projected catch point (d) is then used as a starting point for the stakeout of the surface reference peg (g).

1. Stake out the position of the catch point by using **Difference in offset** and/or **Difference in height** on the Stake/Check panel. When **Difference in offset** and **Difference in height** are equal to zero, the catch point has been located.
2. Define the hinge height difference.
Fn Tools to access the Tools panel.
3. Select **Place surface reference peg** to access the define panel for the reference peg field. The measured position from step 1. is used as the catch point for the stake out of the reference point. The **Actual hinge height diff** field displays the **Hinge ht diff** value from the Stake/Check panel. Type in the appropriate value for **Defined hinge ht diff**.
4. Stake out the surface reference point relative to the projected catch point. Values in **Stake Slope Ref Pt Surface** guide you to the position to place the peg. The defined hinge height difference (h) is already taken into account. Values to be marked on the reference peg can be found on **Stake Slope Ref Pt Surface, Info** page.

- ↶ to return to **Stake Slope**. Stake out the next catch point from this panel.

The closer the real catch point and the approximated stakeout catch point are, the closer the projected catch point gets to the real catch point.

45.3

Staking/Checking the Road

45.3.1

The Stake/Check Panel

Stake,



page

Check panel,



page

The **Stake Line** is shown as example.

Only lines from the selected layer are displayed.

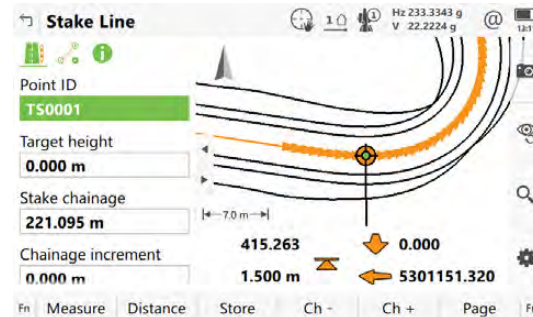

Colour coding



Working job data is displayed in grey. Design job data is displayed in full colour.

Selected line	Colour
Working line	Orange
Centreline	Green
Selected line	Thick black

Key	Description
Measure	For GS: To start measuring the point being staked. The key changes to Stop . For TS: To measure a distance and store distance and angles.
Stop	For GS: To end measuring the point being staked. When Automatically stop point measurement is checked in GS Quality Control, General page recording of positions ends automatically as defined by the stop criteria. The key changes to Store . After ending the measurements, the differences between the measured point and the point to be staked are displayed.
Store	For GS: To store the measured point. When Automatically store point is checked in GS Quality Control, General page, the measured point is stored automatically. The key changes to Measure .

Key	Description
	For TS: To store angles and distance. Distance must be measured before.
Distance	For TS: To measure a distance.
Ch -	Available for Stake road . To decrease the chainage as defined by Chainage increment .
Ch +	Available for Stake road . To increase the chainage as defined by Chainage increment .
Page	To change to another page on this panel.
Fn Settings	To configure the app. Refer to "43.3 Configuring Roads Apps".
Fn Position	For TS: To position the TS to the defined stakeout point, including defined offsets. The settings for Automatically aim instrument to point being staked in Road Settings, TS specific page , apply. Refer to " Road Settings,TS specific page".
Fn Tools	To access the method-specific toolbox. Refer to "45.4 The Toolbox".

Description of fields

Field	Option	Description
		The following fields are always shown in all Stake and Check methods.
Point ID	Editable field	Name of the next point to be stored. The ID is incremented/decremented whenever a point gets stored.
Antenna height	Editable field	For GS: Height of the antenna.
Target height	Editable field	For TS: Height of the prism.
		The following fields are always shown in all Stake methods, except for method Layer .
Stake chainage	Editable field	Nominal chainage of the point to be staked out. To get the information relative to the current measured TS position or the current GS location without leaving the app: <ol style="list-style-type: none"> 1 Tap into the Stake chainage field. 2 Use the Backspace button to delete the whole content in the field. <div data-bbox="1358 1669 1461 1724" data-label="Image"> </div> 3 Press the ENTER button. <div data-bbox="1358 1808 1461 1843" data-label="Image"> </div> <p>---- is displayed.</p>

0014264.001

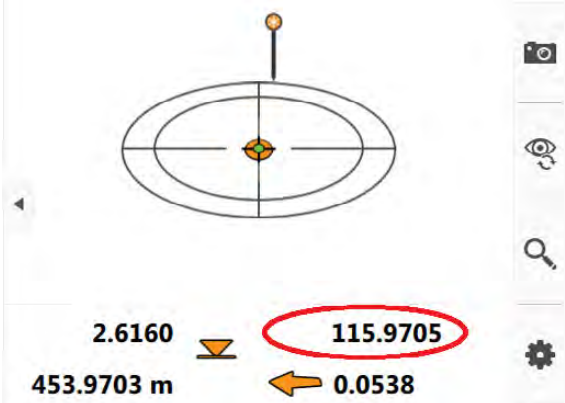
Field	Option	Description
		In 3D viewer, the current chainage is displayed without arrow symbols.
		
Chainage increment	Editable field	Chainage increment. Value by which the nominal chainage increases/decreases when pressing Ch -/Ch + .



Next step

Page changes to the  page.

Stake/Check panel, page

Refer to "Stake,pageCheck panel,page" for a description of keys.

Description of fields

Field	Option	Description
Use offsets	Check box	When this box is checked, the defined stake/check offsets are applied.
Offset	Editable field	<p>Available for Stake. Horizontal offset from the reference line of the point to stake.</p> <p> When a stake offset is entered for line, local line, manual slope and local manual slope and Use non-perpendicular offset is checked on the  page: When coming to a corner when working at a stake chainage along an alignment, choose one of the following from the message:</p> <ul style="list-style-type: none"> • Previous: To stake out the point according to the tangent direction of the previous line. • Average: To stake the average tangent direction. The stake distance from the corner is the offset value defined. • Next: To stake out the point according to the tangent direction of the next line.

Field	Option	Description
CL stake offset	Editable field	Available for Stake with Layer . The horizontal offset from the centreline define the Easting and Northing values for staking. The height is derived from the layer.
Height off-set	Editable field	Available for Stake. Vertical offset from the reference line or surface of the point to stake.
Toggle off-sets	Check box	When this box is checked, points can be staked/checked on the left/right side of the selected line in one process.

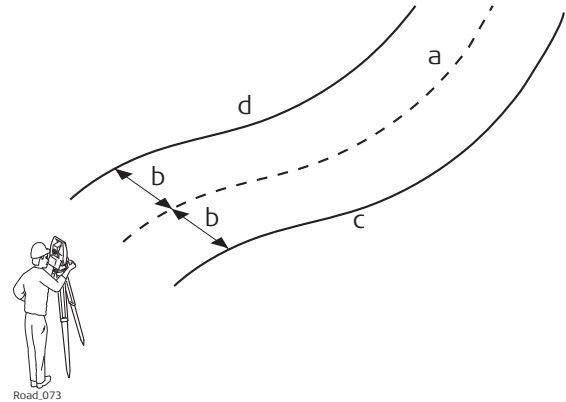

- a Line
- b Defined **Offset**
- c Parallel right line
- d Parallel left line

This functionality is available for the following stake out/check methods:



- **Line:** Toggle between line left and right.
- **Surface grade:** Toggle between left and right line of the surface grade.
- **Crown:** Toggle between left and right surface grade.

The app automatically detects which side of the centreline is being used and selects the appropriate line as a reference.

Auto position

When pressing auto position **Fn Position**, available in TS mode, a message box comes up prompting if either the left or right side should be staked out/checked.

Check off-set	Editable field	Available for Check. Horizontal offset from the reference line, as defined by the chosen method, of the point to stake.
Centreline check off-set	Editable field	Available for Check with Layer . The horizontal offset from the centreline define the Easting and Northing values for checking. The height is derived from the layer.

Field	Option	Description
Check height diff	Editable field	Available for Check. Vertical offset from the reference line or surface, as defined by the chosen method, of the point to stake.
 The following field is shown for the Stake methods Line, Local line, Local manual slope and Manual slope .		
Use non-perpendicular offset	Check box	When this box is not checked the measured point is projected in a right angle to the selected line. When this box is checked, any projection angle can be defined.
Offset angle	Editable field	Manually defined projection angle.
 The following fields are shown in the Line, Local line, Surface grade and Crown methods when Show information to an additional line is checked in the Define panel.		
Apply offsets to additional line	Check box	When this box is checked, an offset to the additional line can be defined.
Horizontal offset	Editable field	Horizontal stake/check offset to the additional line.
Vertical offset	Editable field	Vertical stake/check height difference to the additional line.

Next step

Page changes to the  page.

Understanding priorities of various heights

Type of height	Overrules	Height offset
Manually entered OR Obtained from individual point	All other heights	Considered
Use DTM height for stakeout (toolbox: Use heights from DTM)	Design height	Considered
From design	No other heights	Considered
Show DTM height difference on Info page (toolbox: Use heights from DTM)	No influence on priorities For additional info only	-

Stake/Check panel, page

A user-definable  page exists for each of the stake methods and check methods. Refer to the chapters from "43.3.2 Road Line - Info Page" to "43.3.8 Road DTM - Info Page".

Refer to "Road Settings, Info page" for information on all available items for the  page and how to select them.

Stake/Check panel, 3D viewer

3D viewer for Stake shows information about the measured point relative to the design. The design is defined by the selected layer and line, and the values entered on the **General** page.

3D viewer for Check and Stake are similar. Stake contains the Stake view, along with 2D/3D view, cross section view and navigation view.

For Check and when only a DTM job is used, 3D viewer shows the DTM and the lines of selected Road layer - always in plan view.

At the top, DTM height and delta height are shown.

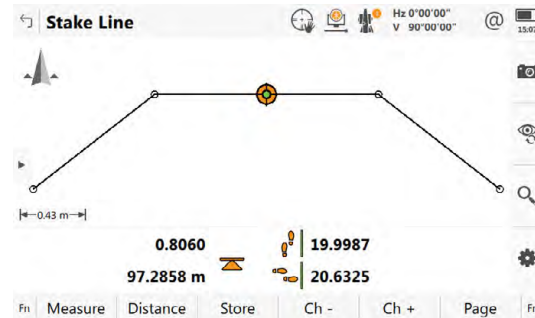

Refer to "Stake,pageCheck panel,page" for a description of the icons.

For Stake, extra information is shown at the bottom:

1. Difference in chainage is shown with some footsteps
2. Horizontal offset is shown with some footsteps
3. Height difference is shown as an arrow
4. Current height
5. The element to stake is shown as an orange and green dot
6. The plot can be shown as profile view, plan view, orbital view and navigation view.

45.3.2

Measuring Points by Chainage and Offset

Graphical overview

Stake road

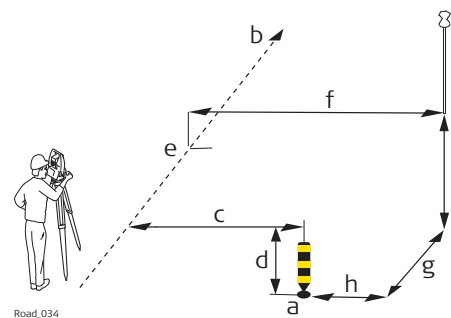

Check road

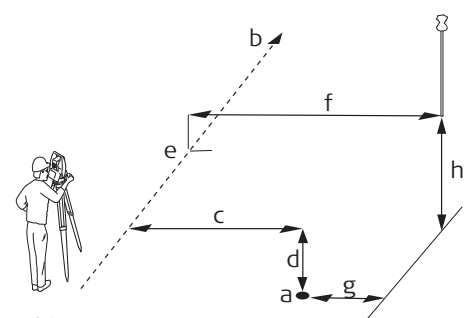

- | | | | |
|---|---|---|---|
| a | Position to stake out, defined by chainage, stake offset and, optionally, stake height difference | a | Position to check, defined by check offset and, optionally, check height difference |
| b | Centreline/line that the position is defined relative to | b | Centreline/line that the position is defined relative to |
| c | Offset | c | Check offset |
| d | Height offset | d | Check height diff |
| e | Working chainage | e | Working chainage |
| f | CL offset | f | CL offset |
| g | Difference in chainage | g | Difference in offset |
| h | Difference in offset | h | Difference in height |
| i | Difference in height | | |

Description

- When staking points, the points are defined by the stake chainage and, if enabled, by the stake offset and the stake height difference relative to an existing 2D or 3D centreline or line.
- When checking points, the points are defined by the check offset and the check height difference relative to an existing 2D or 3D centreline or line.

Required elements

- For 2D, a horizontal centreline is required.
- For 3D, a 3D centreline is required.

45.3.3

Measuring Lines Relative to a Centreline

Graphical overview

Stake road

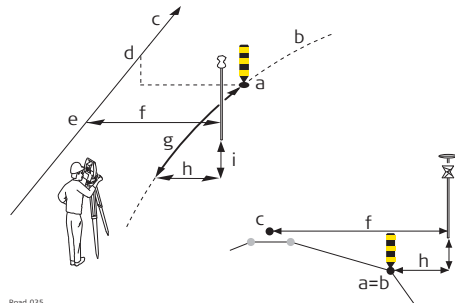

- | | |
|---|-------------------------------|
| a | Position to stake out |
| b | Line to stake out |
| c | Centreline |
| d | Stake chainage |
| e | Chainage |
| f | CL offset |
| g | Difference in chainage |
| h | Difference in offset |
| i | Difference in height |

Check road

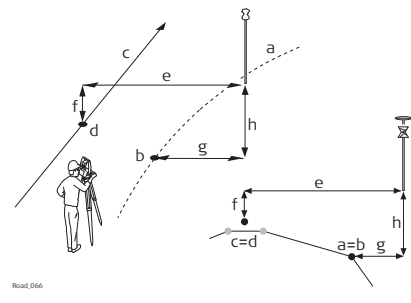

- | | |
|---|-----------------------------|
| a | Line to check |
| b | Projected point on line |
| c | Centreline |
| d | Chainage |
| e | CL offset |
| f | CL height diff |
| g | Difference in offset |
| h | Difference in height |

Description

- Lines define various elements, including:
 - Centreline of the design
 - Change in slope ratio, for example, the edge of a carriage way
 - Gutter, cable, pipeline or any other type of alignment element
- Refer to "43.6.3 Road - Basic Elements for Stake and Check Measurements" for information on the usage of lines.

Required elements

- For 2D, at least a 2D line and a 2D centreline are required.
- For 3D, a 3D line and a 2D or 3D centreline are required.

45.3.4

Measuring Local Lines without Centrelines

Graphical overview

Stake road

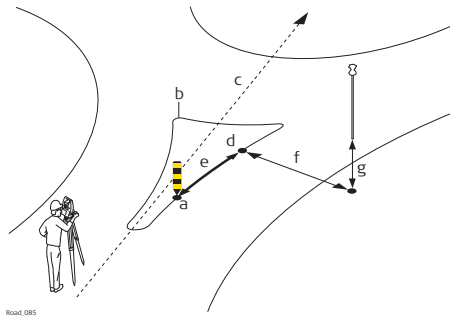

Stakeout of Roundabout

- a Position to stake out
- b Line to stake out
- c Centreline of the layer- is not used for the local line
- d **Chainage**
- e **Difference in chainage**
- f **Difference in offset**
- g **Difference in height**

Check road

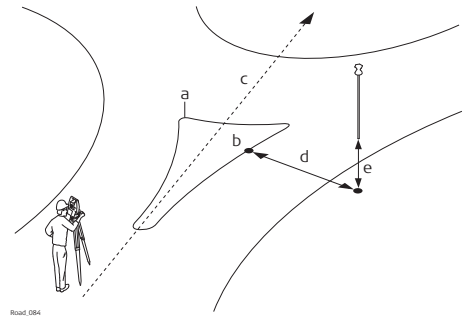

Checking a Roundabout

- a Line to check
- b **Chainage**
- c Centreline of the layer- is not used for the local line
- d **Difference in offset**
- e **Difference in height**

Description

This process is different to lines, where the stake/check is always relative to the centreline defined for the layer. Local lines no longer have a relationship to an overall centreline. Local lines are used to check roundabouts, parking bays, subdivision works and any other type of lines. The different lines to stake/check can be stored within one layer, which does not require a defined centreline. This ability is different to the stake/check of any other type which always require a centreline.

Required elements

A 2D or 3D design of the line to stake/check is required.

45.3.5

Indefinite Triangle

Description

In almost all situations, a measured position is shown relative to the local line by the line chainage and a square offset to the line. However, situations can arise where a road design has extreme changes in the deflection angle of tangent points. In these cases, it is not always possible to show a measured position by the nominal chainage and offset. An indefinite triangle is a region in which these situations arise. Points measured within an indefinite triangle are shown relative to the tangent point.

Graphic

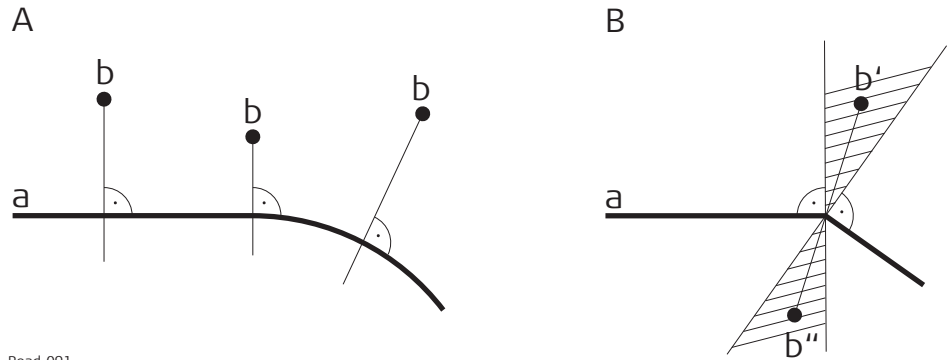

Road_091

Road Design A

- a Local line
- b Measured position, displayed relative to the line by chainage and square offset

Road Design B

- a) Local line with extreme changes in the deflection angle of tangent points
- b') Measured position within indefinite triangle
This position **cannot** be shown in the usual manner and is displayed relative to the tangent point
- b'') Measured position within indefinite triangle
This position **can** be shown in the usual manner. Chainage and square offset display the position.

Panel

Points measured within an indefinite triangle are always shown relative to the tangent point.

45.3.6

Measuring Surface Grades

Graphical overview

Stake road

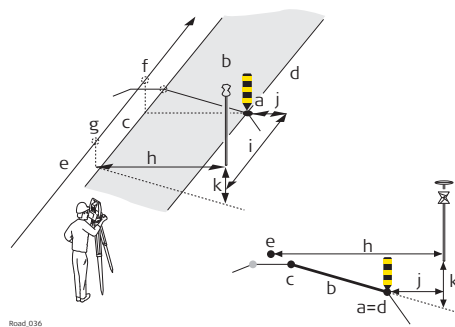

Road_036

Check road

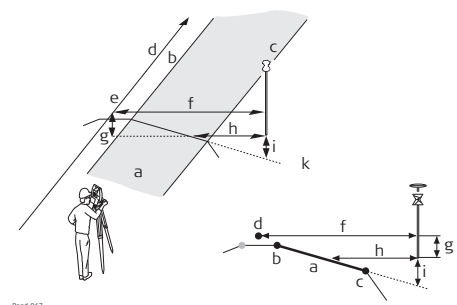

Road_067

a	Position to stake out	a	Surface grade to check
b	Surface grade to stake out	b	Left line
c	Left line	c	Right line
d	Right line	d	Centreline
e	Centreline	e	Chainage
f	Stake chainage	f	Difference in offset
g	Chainage	g	Difference in height
h	CL offset	h	Surface grade offset
i	Difference in chainage	i	Surface grade ht diff
j	Difference in offset		
k	Difference in height		

Description

- Surfaces such as the final carriage way, are often staked/checked using surface grades. A surface grade consists of a combination of two lines.
- Refer to "43.6.3 Road - Basic Elements for Stake and Check Measurements" for information on the usage of surface grades.

Required elements

A 3D design of the road is required.

45.3.7

Measuring Manual Slopes, Local Manual Slopes and Design Slopes

Graphical overview

Stake road

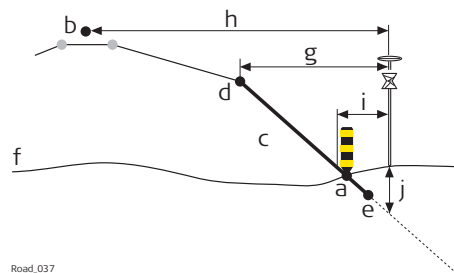

Road_037

a	Catch point
b	Centreline
c	Slope to stake out
d	Hinge point = left line
e	Second/right line
f	Natural surface
g	Hinge offset
h	CL offset
i	Difference in offset
j	Difference in height

Check road

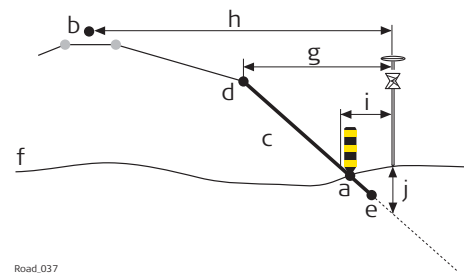

Road_037

a	Catch point
b	Centreline
c	Slope to check
d	Hinge point
e	Second line of the slope
f	Natural surface
g	Hinge offset
h	CL offset
i	Slope offset
j	Slope height diff

Description

- Surfaces, such as the end slopes of a cut or fill, are staked/checked using slope methods.
- Slopes are defined by two lines. Refer to "43.6.3 Road - Basic Elements for Stake and Check Measurements".
- When staking slopes, the point of interest is the intersection of the defined slope with the natural surface (= catch point). Refer to "45.2.3 Advanced Slope Settings" for information on the slope staking methods supported.
- When checking slopes, the slope check is independent of the slope method selected.

Description of manual slopes	The slope is defined manually relative to a selected 3D centreline, slope direction and slope ratio or relative to a 2D line using a manual height, slope direction and slope ratio. Chainage information is related to the centreline.
Description of local manual slopes	The slope is defined manually relative to a selected 3D line, slope direction and slope ratio or relative to a 2D line using a manual height, slope direction and slope ratio. Chainage information is related to the selected line itself and not the centreline of the layer.
Description of design slopes	For this method, a 3D representation of the slope, defined by two lines, is required.

45.3.8 Measuring Road Crowns

Graphical overview

Stake road

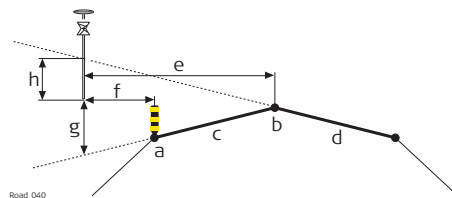

- a Position to stake out, in this case the left line of the crown
- b Middle line of the crown, in this case also the centreline
- c Left surface grade to stake out
- d Right surface grade to stake out
- e **CL offset**
- f **Difference in offset**
- g **Difference in height to left cross slope**
- h **Diff in ht to right surface**

Check road

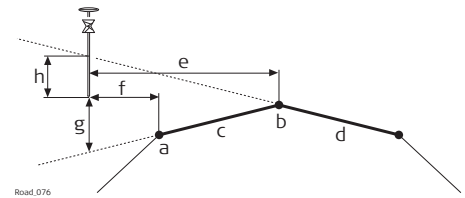

- a Left line of the crown
- b Middle line of the crown, common for both surface grades
- c Left surface grade to check
- d Right surface grade to check
- e **CL offset**
- f **Difference in offset**
- g **Difference in height to left cross slope**
- h **Diff in ht to right surface**

Description

- Staking road crowns allows the stake out of two surface grades at the same time. If **Toggle offsets** is checked, the reference for **Difference in offset** is automatically switched between the right and left surface grade depending on whether the measured position is to the right or left of the middle line.
- When checking road crowns, it allows the check of two surface grades at the same time. The information for both surface grades is shown at the same time.

Required elements

A 3D design of the road, defining a crown consisting of three lines, is required.

Specific fields

Field	Option	Description
Difference in height to left cross slope/ Diff in ht to right surface	Display only	Vertical offset to the left/right surface grade defining the road crown.

45.3.9

Measuring Road Layers

Graphical overview

Stake road

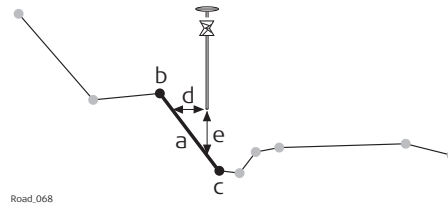

Road_068

- a Relevant part of the layer for the current position
- b Left line **Left name**
- c Right line **Right name**
- d **Difference in offset**
- e **Difference in height**

Check road

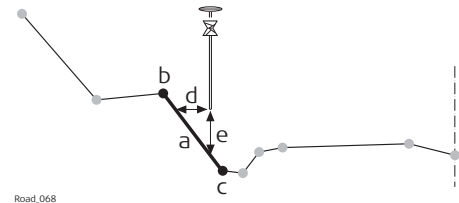

Road_068

- a Relevant part of the layer for the current position
- b Left line **Left name**
- c Right line **Right name**
- d **Slope offset**
- e **Layer ht diff**

Description

All lines are grouped in layers. Such a layer describes a surface of the road. When staking/checking out a layer, it is automatically detected the line left and right of the measured position.

Required elements

A 3D design of the road is required.

45.3.10

Measuring Digital Terrain Models (DTM)

Graphical overview

Check road

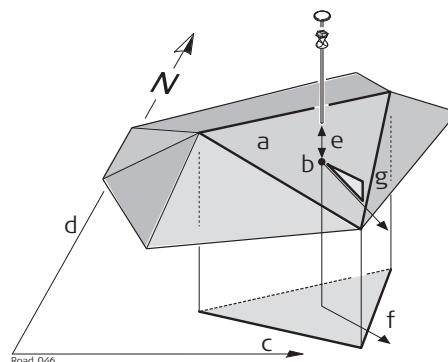

Road_046

- a Relevant triangle of the DTM
- b Projected point on DTM
- c Easting
- d Northing
- e **DTM height diff**
- f **Flow direction**
- g **Flow ratio**

Description

A DTM check returns the height difference between the current height and the height of the DTM at the measured position.

Required elements A DTM job is required.

45.4 The Toolbox

45.4.1 Overview

Access Press **Fn Tools** on any page of the Stake/Check panel.

Description The toolbox contains additional functionality for each of the stake and check methods. This functionality is additional to those already existing functions which are available via the function keys.

The functionality differs between the stake and check methods. Refer to these subchapters for a detailed description of the functionalities:

- "45.4.2 Use heights from DTM"
- "45.4.3 Apply current chainage"
- "45.4.4 Get current angle to alignment"
- "45.4.5 Stake individual point"
- "45.4.6 COGO Road - Alignment info"
- "45.4.7 COGO Road - Create points"
- "45.4.8 Additional Layer Info"
- "45.4.9 Box / base definition"
- "45.4.10 Get current slope"
- "45.4.11 Manual Slope"
- "45.4.12 Reset slope to design"
- "45.4.13 Shift reference line"
- "45.4.14 Recalculate chainage"
- "45.4.15 **Stake intersection point**"

45.4.2 Use heights from DTM

Availability This menu function is available for the following stake/check methods: Line, local line, surface grade, crown, layer.

Description The app offers the possibility to

- switch to a height which is retrieved from an existing height layer, as defined in the selected DTM job. The layer from the DTM is applied and used as a height reference for the staking out or checking of alignments.
- retrieve heights from an existing layer, as defined in the DTM job associated with the project. The DTM used is not considered for the stake values. Three new information lines are added to the **i** page: **DTM height diff**, **DTM height** and **DTM layer**.
- show the DTM triangles in the planar view and in the cross section view in 3D viewer.

Once defined, each layer remains active until it is turned off. DTM heights can be used for both 2D and 3D alignments.

Use Heights From DTM

Key	Description
OK	To confirm the settings and return to the Stake/Check panel.

Description of fields

Field	Option	Description
DTM	Display only	DTM from the selected DTM job.
DTM layer	Selectable list	When selecting a DTM layer the relevant triangle of the DTM is shown in 3D viewer.
Use DTM height for stake out	Check box	When this box is checked, a layer of the DTM is used as a height reference. When this box is not checked, no DTM heights are applied for stakeout or check.
Show DTM height difference on Info page tab	Check box	When this box is checked, a layer of the DTM to be used as a height reference on the page. When this box is not checked, no additional height information relative to the DTM is shown on the page.
DTM layer	Selectable list	Available when Show DTM height difference on Info page tab is checked. Layer of the DTM to be used as a height reference. When selecting a DTM layer the relevant triangle of the DTM is shown in cross section view in 3D viewer.

45.4.3

Apply current chainage

Availability

This menu function is available for all stake methods except layer.

Description

To set **Stake chainage** on the page of the stakeout to the current chainage.

45.4.4

Get current angle to alignment

Availability

This menu function is available for the stake/check of lines and local lines.

Description

To project a measured point to the alignment considering the entered **Stake chainage**. This functionality is only available when **Use non-perpendicular offset** is checked in the Stake panel on the page.

Graphic

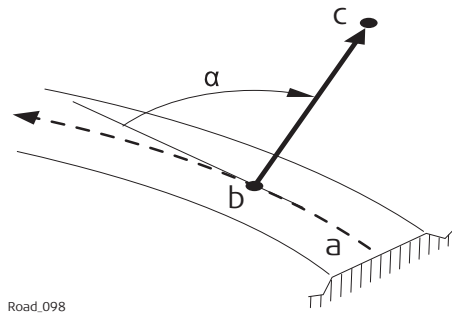

- a Alignment
- b Defined chainage
- c Current position
- α Angle to alignment

Workflow

1. Measure a point:
For TS:
Distance
For GS:
Measure and Stop
2. Press **Fn Tools** to access the toolbox.
3. Select **Get current angle to alignment**.
4. At the defined chainage, the angle between the tangent direction and the direction to the current position is calculated. This angle is set as **Offset angle** for **Use non-perpendicular offset** on the  page.
5. Continue with staking out using the calculated **Stake chainage** and **Offset angle** values. These values are valid until new values are defined manually or by using **Get current angle to alignment**.

45.4.5

Stake individual point

Availability

This menu function is available for the stake/check of lines and local lines.

Description

To stake out points with known Easting, Northing and Height. Points can either be selected from the job or manually typed in.

If a design job has been selected, a point from the design job can be selected. When staking out/checking an individual point, the selected point is set in relation to the alignment and all line relevant values are calculated and displayed.

The **Stake chainage** and **Offset** of the Stake panel are calculated based on the coordinates of the selected point.

 If the chosen point has no height the design height is used. If the point has a height it is possible to use that one or continue working with the design height.

45.4.6

COGO Road - Alignment info

Availability

This menu function is available for staking/checking a line/local line.

Description

This function allows

- the selection of existing single or multiple points from a job.
- viewing the selected points along the alignment.
- displaying the respective alignment chainage and offset information.



Any job containing points from any data storage device can be used.

The calculated alignment information is stored and a report sheet can be used for extracting the data.

Point Selection

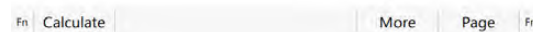
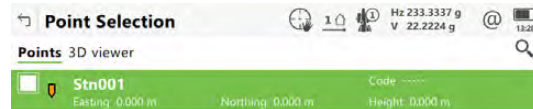
To select a point, check the box in front of the point ID.



Key	Description
Calculate	To perform the chainage and offset calculation and to continue with the subsequent panel. Calculated COGO points are not yet stored.
More	To display information about the codes if stored with any point, the Easting, Northing, Elevation, time, date and 3D coordinate quality. <ul style="list-style-type: none">  The order in which the Easting and Northing columns are shown depends on the Grid format configured to be used in Regional, Coordinates page.  The Easting, Northing and Elevation values are shown in the unit configured in Regional, Distance page.
Page	To change to another page on this panel.
Fn None or Fn All	To deactivate or activate all points for the COGO calculation.
	Point selection/deselection is possible on the 3D viewer page.
IF	THEN
a single point is to be selected/deselected	tap on the point.
multiple points are to be selected/deselected	drag the stylus on the panel in a diagonal line to make a rectangular area.
all points are to be selected	press All or None .

Next step

Calculate computes the alignment information.

Alignment Results, Points page

Displayed is information about the calculated alignment information: Horizontal offset from the line, height difference from the defined line and horizontal offset from the centreline.

Key	Description
Store	To store the results. Points are stored in the job together with the alignment information. The points can be exported with a report sheet later. The information is the same as if the points had been measured along the alignment.
Page	To change to another page on this panel.
Fn Settings	To configure if the calculated points are stored with the original point ID, a prefix or a suffix.

Next step

Page changes to another page.

The fields and information displayed on the  page are as defined in **Road Settings, Info** page. Refer to "Road Settings, Info page".

3D viewer displays all the calculated points against the design data.

Settings

Description of fields

Field	Option	Description
Store point ID with	Same point ID	The same point ID from the selected job is used when storing to the job. If a point exists with the same point ID in the job a warning appears. Choose to overwrite the existing point or not.
	Prefix	Adds the setting for Store point ID with in front of the original point IDs.
	Suffix	Adds the setting for Store point ID with at the end of the original point IDs.
Prefix / suffix	Editable field	The identifier with up to four characters is added in front of or at the end of the ID of the calculated COGO points.

45.4.7

COGO Road - Create points

Availability

This menu function is available for staking/checking a line/local line.

Description

This function allows creating points by defining a distance between points along the working line and offsets to the working line.

Define Line Segmentation

Key	Description
Calculate	To perform the point calculation and to continue with the subsequent panel. Calculated points are not yet stored.
Init Ch	Available when Start chainage is highlighted. To insert the initial chainage of the line.
Final Ch	Available when End chainage is highlighted. To insert the final chainage of the line.

Description of fields

Field	Option	Description
Calculate segment from	Number of points	How the line is divided. Depending on the selection, the following fields are editable or display only fields. The number of points defines the distance between the points.
	Chainage increment	The line along which the points are created is defined by Start chainage and End chainage . The distance between the points is fixed by a constant distance (Chainage increment).



SYS13_002

P0 **Start chainage**

P1 **End chainage**

d Equally spaced segments result from dividing a line by a certain number of points.

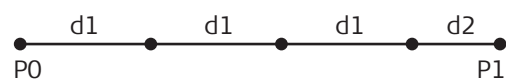

SYS13_003

P0 **Start chainage**

P1 **End chainage**

d1 **Chainage increment**

d2 Remaining segment

Field	Option	Description
	Create single point	One point will be created at a defined chainage and with the offsets entered.
Chainage	Editable field	Available for Calculate segment from: Create single point . The position of the new point along the line.
Start chainage	Editable field	Available for Calculate segment from: Chainage increment and Calculate segment from: Number of points . The beginning chainage of the line.
End chainage	Editable field	Available for Calculate segment from: Chainage increment and Calculate segment from: Number of points . Chainage at the end of the line.
Line length	Display only	Calculated line length between Start chainage and End chainage .
Number of points	Editable field or display only	Available for Calculate segment from: Chainage increment . The number of points that fits between Start chainage and End chainage , considering the defined Chainage increment .
Chainage increment	Editable field or display only	Available for Calculate segment from: Chainage increment . The constant distance between the points.
Last segment length	Display only	Available for Calculate segment from: Chainage increment . The length of the remaining segment.
Horizontal offset	Editable field	The perpendicular distance between the line and the point. A positive offset is to the right, a negative offset is to the left.
Apply on both sides	Check box	Available for Calculate segment from: Chainage increment and Calculate segment from: Number of points . When this box is checked, the points are created on both sides of the line no matter if the value entered for Horizontal offset is positive or negative.
Vertical offset	Editable field	Vertical height difference from the line to the point. A positive offset is above the line, a negative offset is below the line.



For multiple chainages refer to "43.6.5 Road - Chainage or Station Equations".

Next step

Calculate to access **COGO Road Store Results**.

COGO Road Store Results, Storage page

Enter additional data before storing the calculated points.

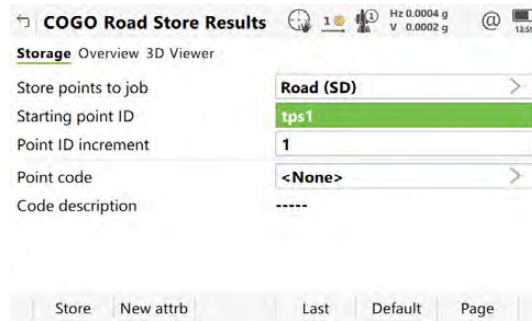

Key	Description
Store	To store the result.
Page	To change to another page on this panel.

Description of fields

Field	Option	Description
Store points to job	Selectable list	The calculated COGO points are stored in this job.
Starting point ID	Editable field	Available for Calculate segment from: Chainage increment and Calculate segment from: Number of points . The point ID to be assigned to the first new point on the line. The selected point ID templates from ID Templates are not applied.
Point ID increment	Editable field	Available for Calculate segment from: Chainage increment and Calculate segment from: Number of points . Is incremented numerically for the second, third, and so on, point on the line.
Point ID	Editable field	Available for Calculate segment from: Create single point . The name of the new point.
Code	Selectable list	Select a point code for the setup point if desired. The codes from the job codelist are used.
Code description	Display only	A description of the code.

Next step

Page changes to the **Overview** page.

The variables used for the calculation are displayed.

Key	Description
Store	To store the result.
Page	To change to another page on this panel.

COGO Road Store Results, Overview page

Description of fields

Field	Option	Description
Number of new points	Display only	Number of points being calculated. If Apply on both sides was checked in Define Line Segmentation , the number of calculated points is twice the value entered in Define Line Segmentation .
Chainage increment	Display only	Available for Calculate segment from: Chainage increment and Calculate segment from: Number of points . The constant distance between the points.
Chainage	Display only	Available for Calculate segment from: Create single point . The position of the new point along the line.
Horizontal offsets applied	No, To left, To right or Both	Indicates if and to which side a horizontal offset was applied.
Vertical offsets applied	No, Up, Down	Indicates if and to which side a vertical offset was applied.

Next step

Page changes to the **3D Viewer** page.

45.4.8

Additional Layer Info

Availability

This menu function is available for all stake/check methods except layer.

Description

This function allows additional road data to be obtained during a check or stake survey of a road element.

Road elements include centrelines, kerb and gutters and slopes.

The map shows cross section view only and allows setting the vertical exaggeration.

Additional Layer Info

Tap on the relevant element for selection. The information displayed shows the current slope ratio and the height difference of the element. Also displayed are the offset and height differences from the left and right vertices of the element.

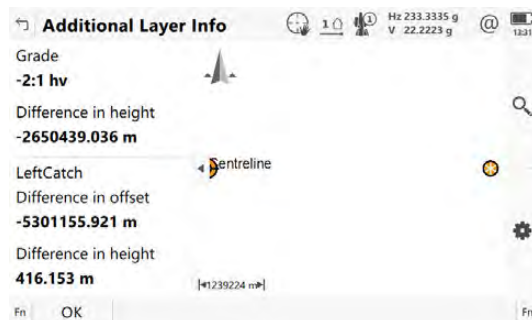

Key	Description
OK	To store the selected element, which is then automatically recalled.

45.4.9

Box / base definition

Availability

This menu function is available for the stake/check of lines and local lines.

Description

This function allows a box or similar structure to be set out during a check or stake survey of a road element. The box is set out relative to a line chainage and parallel offset. A base point of the box, user-defined dimensions of the box (a base distance and a base offset) are required.

Diagram

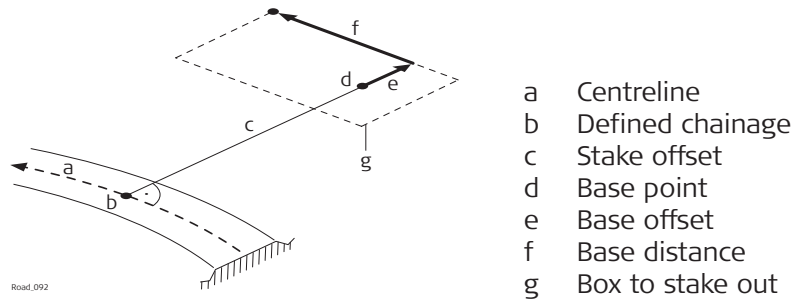

Box / base definition

Box / Base Definition	
Base chainage	221.095 m
Base offset	0.000 m
Distance box	0.000 m
Offset box	0.000 m
Base easting	-19807.736 m
Base northing	5301114.314 m
Base height	416.763 m
Base direction	99.7621 g

OK Define Base

Key	Description
OK	To store the selected element, which is then automatically recalled.
Define	To overwrite the values before pressing Base if a different base had been defined before.
Base or Clear	To freeze or unfreeze the values of the base point.

Description of fields

Field	Option	Description
Base chainage	Display only	The position defined by Stake chainage .
Base offset	Display only	The position defined by Offset .
Distance box	Editable field	The distance in the direction of increasing chainage of base point is positive.

Field	Option	Description
Offset box	Editable field	The offset to the right of base point is positive.
Base easting, Base northing and Base height	Editable field	The coordinates of the base point, either from the job or from a surveyed point.
Base direction	Editable field	The orientation of the local coordinate system (azimuth).

Example

The following steps describe the stakeout of two reference pegs from a centreline chainage and offset.

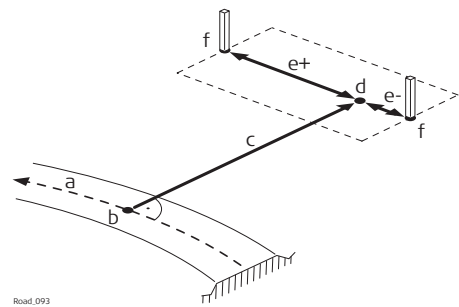

- a Centreline
- b Defined chainage
- c Stake offset
- d Base point
- e Base distance, positive (e+), negative (e-)
- f Peg to stake out

1. Define the base point for the box/base stakeout using **Offset** and **Height offset** from the  page.
2. Press **Fn Tools** to access the toolbox.
3. Select **Box / base definition**. Press **OK** to continue to the next panel.
4. The position defined by **Stake chainage** and **Offset** is used as **Base chainage** and **Base offset** when accessing **Box / base definition** for the first time within a stakeout session.
5. Similar to the stakeout of individual points in the toolbox. The Box/Base functionality calculates the new point to stake out and changes the values of **Stake chainage** and **Offset**.
6. To avoid these values being used as the next base point when accessing the box/base menu, press **Base** in the Box/Base Definition panel. The values of the base point freeze when pressing the key. **Base** is now replaced by **Clear**. If a different base had been defined before, use **Define** to overwrite the values before pressing **Base**.
7. Define the **Distance box** and **Offset box**. Both follow the same rules as used for the definition of offsets and chainages in general. Offset to the right = positive; distance in direction of increasing chainage = positive.
8. Press **OK** to continue to the next panel.
9. The values of **Stake chainage** and **Offset** are adjusted accordingly.
10. The fields **Difference in chainage**, **Difference in offset** and **Difference in height** guide you to the new position to stake out.

Press **Fn Tools** to access toolbox.

11. Select **Box / base definition**.
Press **OK** to continue to the next panel.

12. The next point of the box to stake out can now be defined.

To change back to the original chainage and offset defined for the base point definition use **Clear**.

13. Start with step 1. to define a new box/base.

45.4.10

Get current slope

Availability

This menu function is available for the stake/check of slopes, local manual slopes and manual slopes.

Description

To access **Slope Definition**. The slope ratio **Current slope ratio** of the last measured position is used as the defined **Cut slope/Fill slope**. All other values in **Slope Definition** are filled in with the last measured position. The defined manual slope is used for all points to stake out or check.



The manual slope is active until it is turned off with **Reset slope to design** from the toolbox.

Graphic

Slopes are defined relative to the centreline.

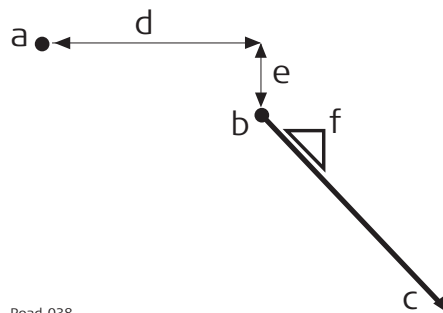

- a Centreline
- b Hinge point
- c New slope
- d Defined hinge offset **Offset**
- e Defined hinge height difference **Height difference**
- f **Cut slope/Fill slope**

Road_038

Slope Definition

Slope Definition	
Hinge line	Centreline
Offset	0.000 m
Height offset type	Absolute
Height	0.000 m
Slope location	Right of hinge
Cut slope	2:1 hv
Fill slope	1:0 hv

Fn OK Fn

Key	Description
OK	To accept changes and move to the next panel depending on the settings for slope staking.

Description of fields

Field	Option	Description
Hinge line	Display only	The line the slope is defined relative to.

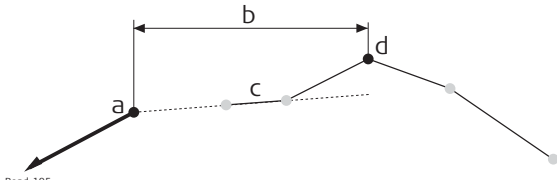
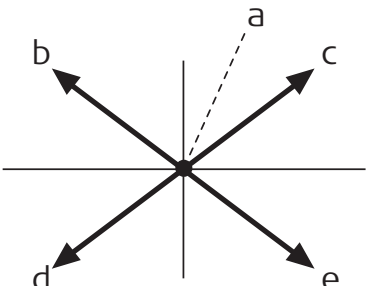
Field	Option	Description
Offset	Editable field	The horizontal offset of the hinge point from the centreline/reference line.
Height offset type	<p>Absolute</p> <p>Relative to line or Hold hinge</p> <p>Relative to surface grade</p>	<p>The vertical offset type for the hinge point.</p> <p>The only option available for 2D lines.</p> <p>Available for 3D lines.</p> <p>Available for Stake: Manual slope. The manual slope is defined by:</p> <ul style="list-style-type: none"> • Hinge offset relative to the selected hinge reference line • Hinge height, calculated by using the hinge offset on the selected surface grade (left or right selected surface grade, depending on Offset - or +)
		 <p>Road_105</p> <p>a Hinge point of manual slope b Defined hinge offset (-) c Left surface grade of design d Selected hinge reference</p>
Height	Editable field	The elevation of the hinge point (absolute height). Available for Height offset type: Absolute .
Slope location	Selectable list	Differentiates if the defined slope is a cut/fill and left/right.
		 <p>Road_079</p> <p>a Hinge point b Left cut c Right cut d Left fill e Right fill</p>

Field	Option	Description
Cut slope and Fill slope	Editable field	Defines the cut/fill ratio of the slope.  The slope ratio format is defined as system setting in Regional, Slope page.

45.4.11

Manual Slope

Availability

This function is available for stake/check of slopes.

Description

To access **Slope Definition**. Allows a manual slope to be defined. The defined manual slope is then used for all points to stake out or check. Refer to "Slope Definition" for a description of the panel.



The manual slope is active until it is turned off with **Reset slope to design** from the toolbox.

45.4.12

Reset slope to design

Availability

This function is available for stake/check of slopes.

Description

This option is only available if a slope has been defined by using **Get current slope**. The manually defined slope is deactivated and reset to the design slope.

45.4.13

Shift reference line

Availability

This menu function is available for the stake/check of slopes and surface grades.

The **Shift reference line** item of the toolbox stays disabled until the first measured position is available. The current chainage is used for the cross section shown to pick the reference line.

Description

When staking out or checking different layers of the road strata, such as the subgrade, gravel or asphalt, it is often found that not all these layers are available in the design. For such cases, the app offers the possibility to apply either a negative or positive height shift to the design values.

Example

A gravel layer with a thickness of 10 cm for stakeout. A negative vertical shift to the final design surface is applied. This shift is applied:

- by pressing **Shifts** in the **Define** panel and
- by applying a vertical shift of -10 cm.

As shown, the selected surface grade is shifted by 10 cm.

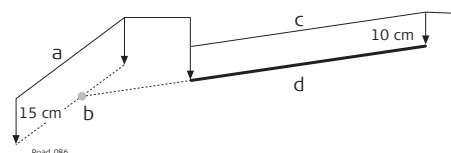

- a Reference surface
- b Shifted reference point
- c Original surface grade
- d Shifted surface grade

When staking out the newly shifted surface grade, the original left edge of the shifted surface grade is of little interest. It is the intersection with the left end slope that is of greater interest.

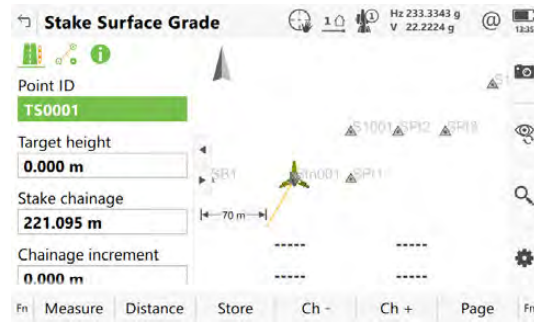

Reference Shift

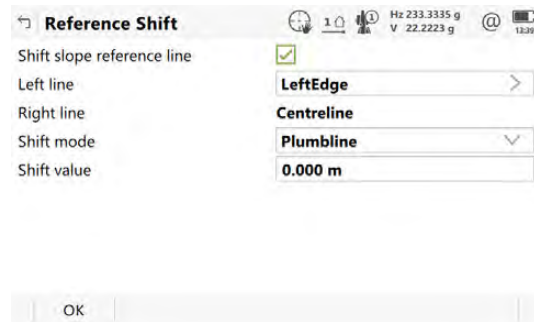

Key	Description
OK	To confirm the settings and return to the Stake/Check panel.

Description of fields

Field	Option	Description
Shift slope reference line	Check box	When this box is checked, the settings for the shift can be set.
Left line	Display only	Shows the name of the left line from the surface.
Right line	Display only	Shows the name of the right line from the surface.
Shift mode		The vertical shift applied to the surface selected.
	Plumbline	The shift defined under Shift value gets applied following the plumb line.
	Perpendicular	The shift defined under Shift value gets applied perpendicular to the selected surface.
Shift value	Editable field	Value the selected surface gets shifted following the chosen Shift mode .

The graphical selection.



The expanded element and the shifted reference line, marked with a cross, are shown in 3D viewer.

Difference in offset and **Difference in height** guide you to the new shifted position.

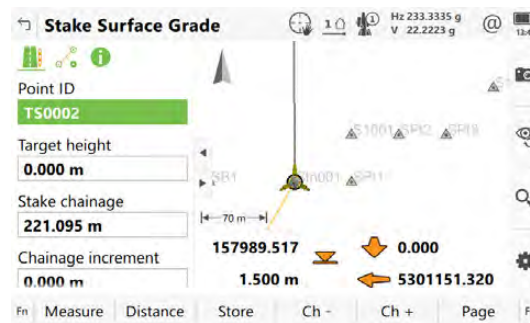

45.4.14

Recalculate chainage

Availability

This menu function is available for all stake/check methods except layer.

Description

When staking or checking complex road designs it can happen that the current position is not projected to the desired segment of the alignment. The **Recalculate chainage** forces a re-projection of the current position.

Example

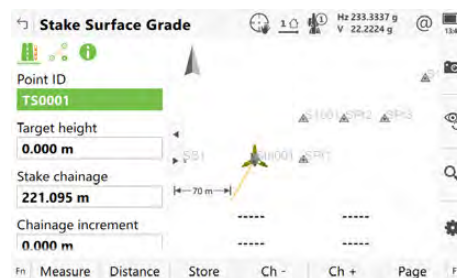

Before initialisation

This panel shows the projection of the current position to the left segment, although the distance to the right segment is shorter.

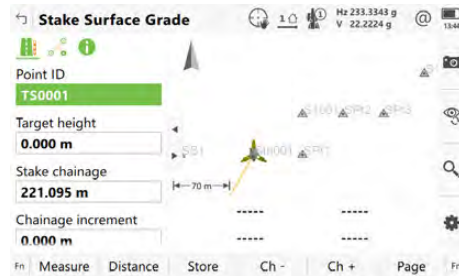

After initialisation

This panel shows the projection after the reinitialisation.

45.4.15

Stake intersection point

Availability

This menu function is available for staking a line with **Show information to an additional line** checked in **Define Line**

The additional line must be a Straight.

Offsets for the selected line and the additional line can be defined.



The menu function **Stake intersection point** is only available if the offsets are defined perpendicular to the selected line. **Use non-perpendicular offset** must not be checked.

Description

Stake intersection point is commonly used to stake out bridge abutment positions. The graphic shows an example.

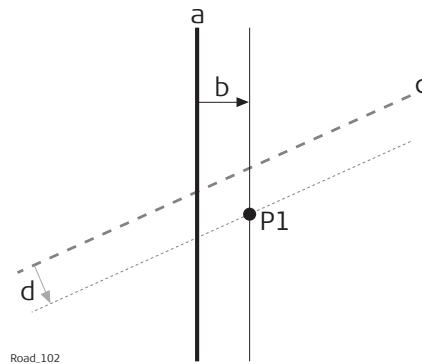

- a Selected line, for example bridge centreline
- b Perpendicular offset from the selected line
- c Selected additional line, for example abutment line
- d Perpendicular offset from the selected line
- P1 Required intersection point for stakeout

Calculation of the stake intersection point and chainage

The calculation of the intersection point is based on:

- A perpendicular offset from the selected line, for example bridge centreline
- A perpendicular offset from the additional line

Step-by-step

1. Define Line

Select the line to work with (bridge centreline) and select a second intersecting line (abutment centreline) under **Show information to an additional line**.

2. Stake Line, page

If necessary, check **Use offsets**. Type in the offset of the intersection point in relation to selected line (bridge centreline).



Non-perpendicular offsets are not allowed. If necessary, check **Apply offsets to additional line**. Type in the offset of the intersection point in relation to the selected additional line (abutment centreline).

3. **Fn Tools** to access the toolbox and select **Stake intersection point**.

In some cases, more than one intersection point can be calculated.

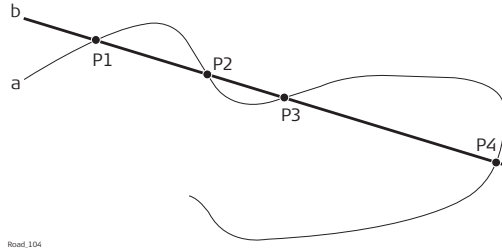

- a Selected line
- b Additional line
- P1 Intersection point 1
- P2 Intersection point 2
- P3 Intersection point 3
- P4 Intersection point 4

In this case, a plot with the possibility to select the desired intersection point appears. The selection is made using the touch screen and a selectable list.

All intersection points are marked with a yellow flag.

The point ID and the point symbol of a selected intersection point are displayed in blue.



4. **Height confirmation**

Depending on the available height information of the selected lines the following possibilities are available to define the height of the intersection point which has been selected for stakeout.

- Using the design height, which is the height of the selected line (bridge centreline). This option is used by default or by pressing **None**.
- Using the height of the additional line as manual height. This option appears when the additional line contains height information.
- Using the average height of the selected line and of the additional line as manual height. This option appears when the additional line contains height information.
- Using **Use heights from DTM** from the toolbox. This option is only available if a DTM has been selected in the job selection panel.

5. **Stake Line**,  page

Depending on the height selection, the check box **Allow editing the height of the location being staked** is enabled automatically and the selected height is used for staking out.

Stake chainage is the intersection of the original line (bridge centreline) and the line which is offset from the additional line. This value is updated automatically.

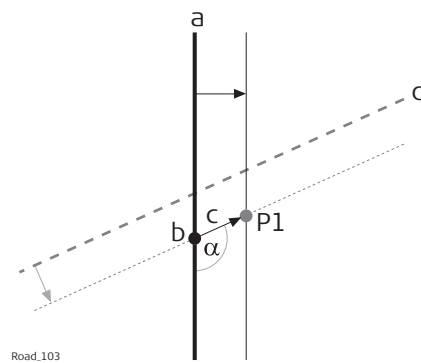

- a Selected line, for example bridge centreline
- b Stake chainage of intersection point
- c Non-perpendicular offset from the selected line
- d Selected additional line, for example abutment line
- α Non-perpendicular offset angle
- P1 Required intersection point for stakeout

6. **Stake Line**,  page

Offset: After pressing **Fn Tools** and selecting **Stake intersection point**, the value is updated automatically to the non-perpendicular offset of the intersection point to the selected line (bridge centreline).

Use non-perpendicular offset: The check box is checked automatically after pressing **Fn Tools** and selecting **Stake intersection point**. **Offset angle** is updated automatically to the non-perpendicular offset angle of the intersection point to the selected line (bridge centreline).



To stake further points along the same alignment to the additional line, update the value for **Offset** by the required distances. In this case, **Offset** is the distance along/parallel to the additional alignment.

7. **Stake Line**

To stake out the selected intersection point, all delta values must be 0.000.

46

Roads - Rail

46.1

Creating a New Rail Job

46.1.1

Overview

Description

There are two ways of creating road/rail jobs:

Typing them in manually by using the **Alignment Editor** app.

OR

Converting data created in a design package.

Manually entered data

Data can be typed in and edited with **Alignment Editor**. Refer to "44 Roads - Alignment Editor" for information on how to enter data manually.

Converted data

The **Alignment editor** app supports various different formats like dxf, LandXML, MxGenio, Terramodel, Carlson.

The Design to Field component of Infinity offers converters from several road/rail design and CAD packages. Several design packages also include a built-in converter to Roads/Rail. As different design packages follow different philosophies in representation, creation and storage of data the conversion process differs slightly.

Infinity can be found on the Infinity DVD.

The latest version of the Design to Field importers can be found in the downloads section of:

- myWorld@Leica Geosystems
<https://myworld.leica-geosystems.com>
-

46.1.2

Installing all necessary Software

Install Infinity

Infinity runs under WindowsXP or Windows Vista and can only be installed successfully if the user is logged in as the Administrator. To install Infinity, run the setup file from the DVD and follow the instructions.

Install Design To Field

To prepare the track design for use on the instrument successfully, the data must first be converted from its original format to an onboard job. This conversion is achieved using Design to Field, a component of Infinity which is automatically installed with Infinity.

Install Importers

The field importers are used by Design to Field to read in the track design. These importers are installed separately and have the file extension *.rri.

The latest version of the Design to Field importers can be found in the downloads section of:

- myWorld@Leica Geosystems:
<https://myworld.leica-geosystems.com>
-

Install Rail Editor

Rail Editor is a computer program for defining the height of the rails relative to the horizontal and vertical alignments (superelevation). Rail Editor is automatically installed into Infinity from the Field Importers install package, which can

be found in the downloads section of the Leica Geosystems website. Rail Editor can be run either externally or within Design To Field.

46.1.3

Importing the Track Design with Infinity

Importing the design

1. **Starting the Design to Field program**
To import a track centreline select Design to Field from the toolbox in Infinity.



2. **Selecting an Import Type**
To prepare track design for onboard use successfully, it has to be converted from its original data format to an onboard job which runs on the instrument.

Select **Importer Type: Rail Data**

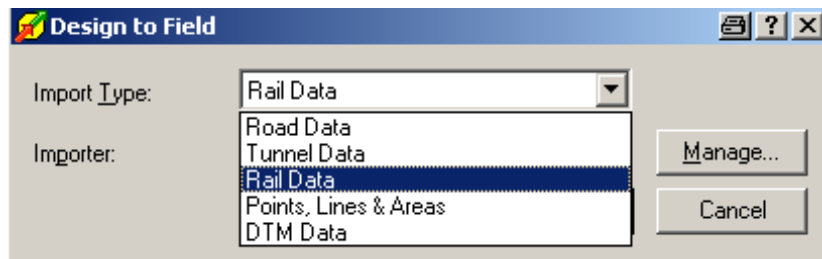

3. **Selecting a Field Importer**
Importers are used to convert the data. Additional importer formats can be added to the selectable list by clicking **Manage**.

Select the importer related to the track design from the selectable list of available importers.

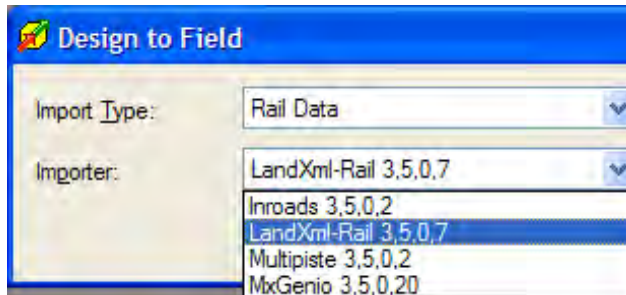

4. **Importing**
Click **Import** to start the file selection wizard.

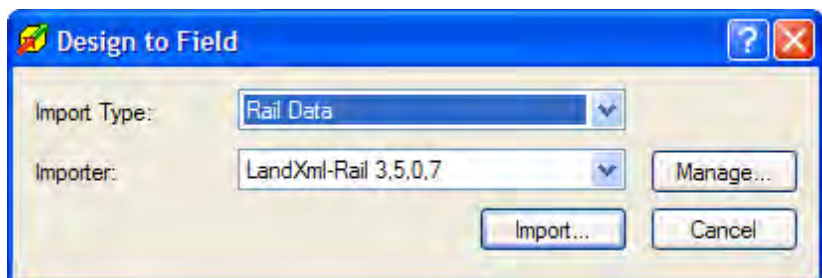

5. Selecting the job type

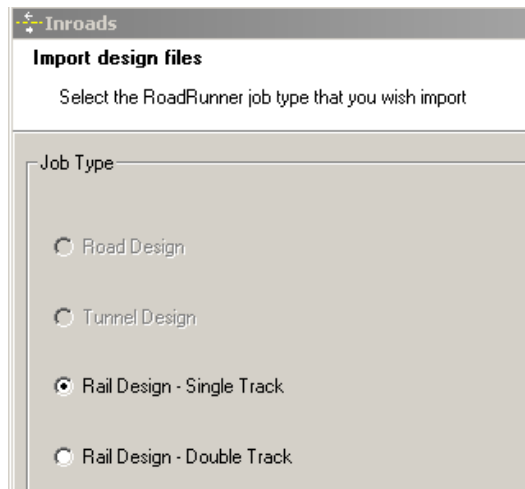

- For single tracks, select **Rail Design-Single Track**.
A single track design can consist of a horizontal alignment, a vertical alignment and superelevation.
- For double tracks, select **Rail Design-Double Track**.
A double track design can consist of a horizontal alignment, a vertical alignment and superelevation for each track. Alternatively, a third horizontal alignment can also be defined and used for calculating the chainage of both tracks (chainage centreline).
Click **Next** to move to the next page of the wizard.

6. Selecting the horizontal and vertical alignment files

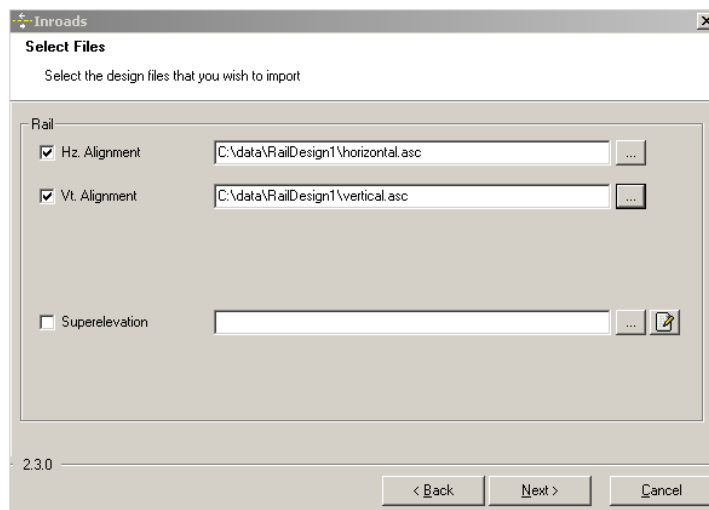

- For a single track, select the horizontal and vertical alignments using the browse button.
- For a double track, three panels are used to define the design data. The arrows at the bottom of the panels can be used to move between the different panels.

First panel - Centreline: The first panel defines the horizontal and vertical alignment of the chainage centreline. If the chainage for each track is to be calculated relative to each track centreline, then it is not mandatory to select a chainage centreline. The horizontal and vertical alignment on the first panel can be left blank.

Second panel - Left track: The second panel defines the horizontal and vertical alignments and the rail definition (superelevation) of the left track.

Third panel - Right track: The third panel defines the horizontal and vertical alignments and the rail definition (superelevation) of the right track.

Click **Next** to move to the next page of the wizard.

7. **Superelevation (rail definition)**

- Design data which is compulsory:
A track design must contain a horizontal alignment.
- Design data which is optional:
A track design can include a vertical alignment and a rail definition (superelevation). Superelevation is only possible when the track design includes a vertical alignment.

A superelevation file can be obtained in the following ways:

- by selecting an existing superelevation file.
- by selecting an existing superelevation file and modifying it with Rail Editor.
- by creating a new superelevation file with Rail Editor.

Creating a superelevation (rail definition)



To create a rail definition (superelevation) for any track, click the **Edit** button next to the Superelevation file name. This action starts the Rail Editor program.

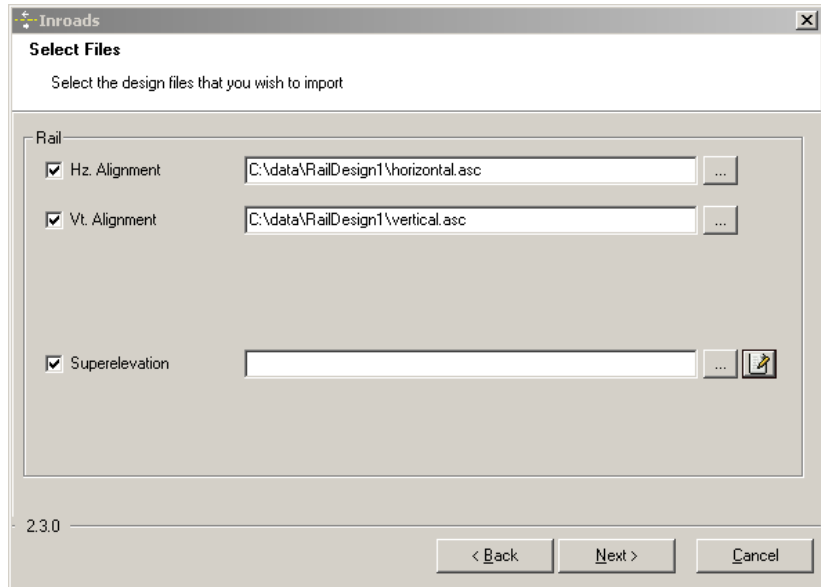

The Rail Editor program is used to define the height of the rails at a given chainage. The height of the rails can be defined by a rotation point and a cant or by a left and right cant.

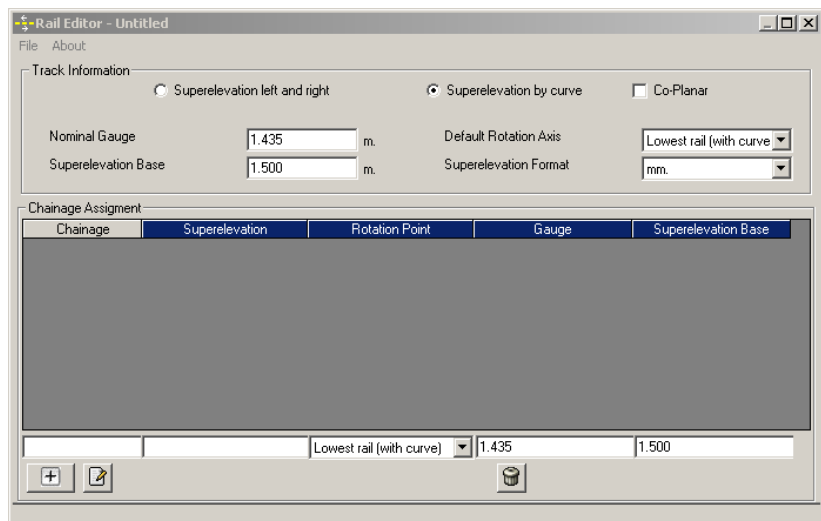

Describing the panel elements - Entering Track Information

Superelevation left and right

To define the height of the rails using one superelevation value for the left rail and another superelevation value for the right rail.

Superelevation by curve



To define the rails using a rotation point and a superelevation value.

Once the method by which the superelevation values are defined has been selected, it cannot be changed

Co-Planar (for multiple tracks)

To define the height of the rails of the second track by extending the plane which runs through the rails of the first track.

Nominal Gauge

The default nominal distance between the active (internal) faces of the left and right rails. This value can be changed if necessary for any rail definition (superelevation).

Superelevation Base

The distance over which the superlevation is applied. This distance is normally the distance between the centre of the left and right rail. This value can be changed if necessary for any rail definition (superelevation).

Default Rotation Axis

If a rotation point is used, this selection is used as the default for all new rail definitions. This value can be changed if necessary for any rail definition (superelevation).

Superelevation Format

The format in which the superlevation values are entered.



Once all superlevation data has been entered, press the button to add the data to the chainage assignment panel.



To delete an element, select the element and press the button.



To modify an existing element, select the element, modify the data and press the button.

Once all values have been entered for the entire alignment, the file can be saved in an XML format using **Save** from the **File** menu.

To return to the Design To Field converter, select **Exit** from the **File** menu.

To modify an existing rail definition (superelevation) file, for example XML files, use **Load** option from the **File** menu.

8. **Entering the alignment tolerances**

Enter the appropriate horizontal and vertical tolerances to be used during the checking of the alignments.

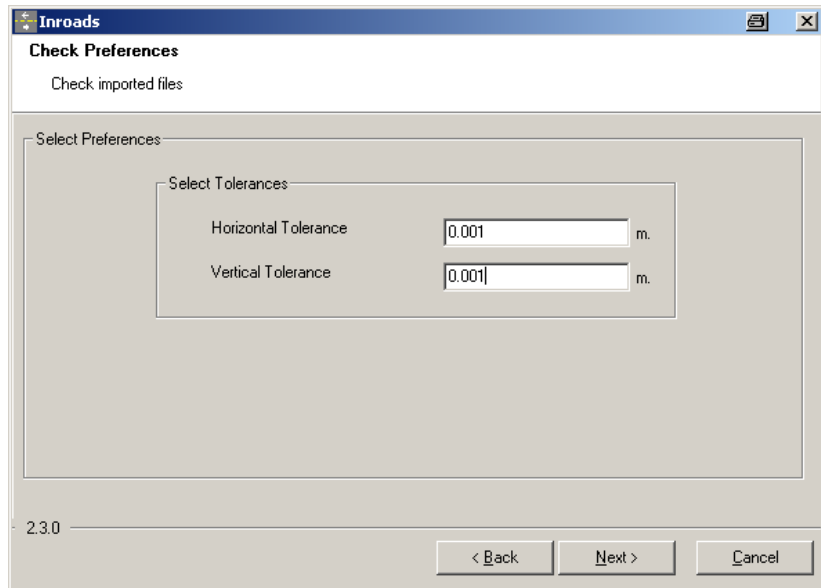

Click **Next** to move to the next page of the wizard.

9. **Checking the track design**

When the track design has been imported, information is displayed to show the success or failure of the import.

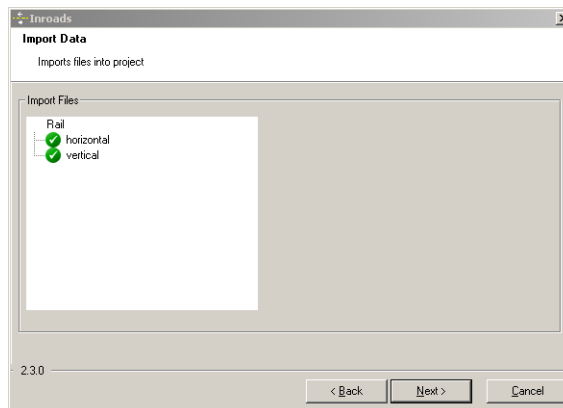

- When the import is successful: Click **Next** to move to the next page of the wizard.
- When the import is unsuccessful: Click **Back** to step back through the wizard.
- If a problem is encountered a red symbol appears. Double-click on the red symbol and a window containing a description of the problem appears.

10. **Entering the range of chainages to be used**
Enter the range of chainages to be exported.

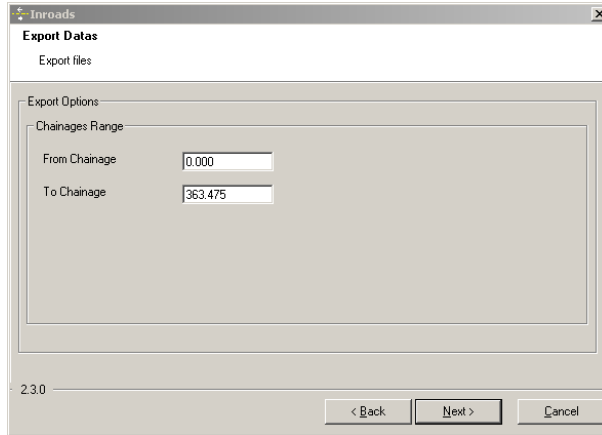

Click **Next** to move to the next page of the wizard.

11. **Checking the summary report**
- When the report is correct: Click **Finish** to complete the wizard.
 - When the report is incorrect: Click **Back** to step back through the wizard.

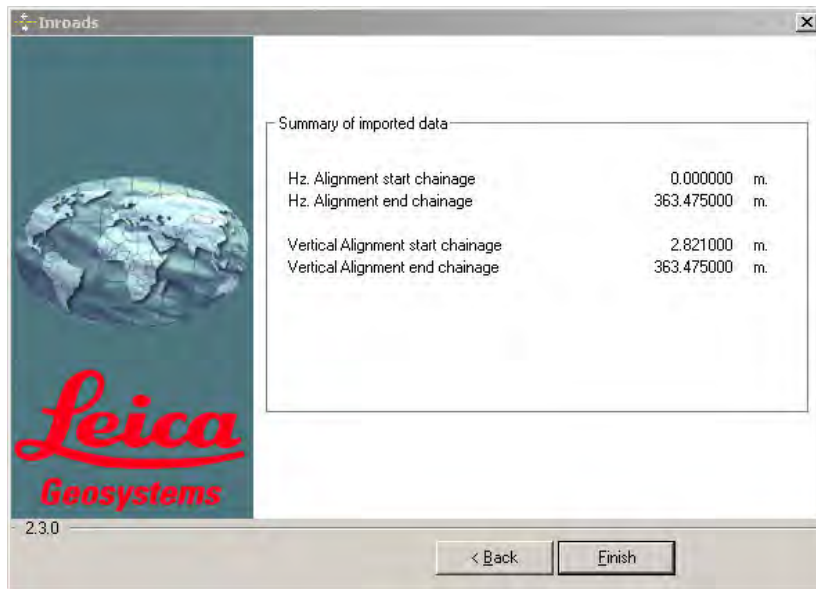

12. **Viewing the track design**
The track design can be viewed graphically.



Click **Export** to create the files for onboard use.

13. **Creating the files for onboard use**
The track design can now be prepared.

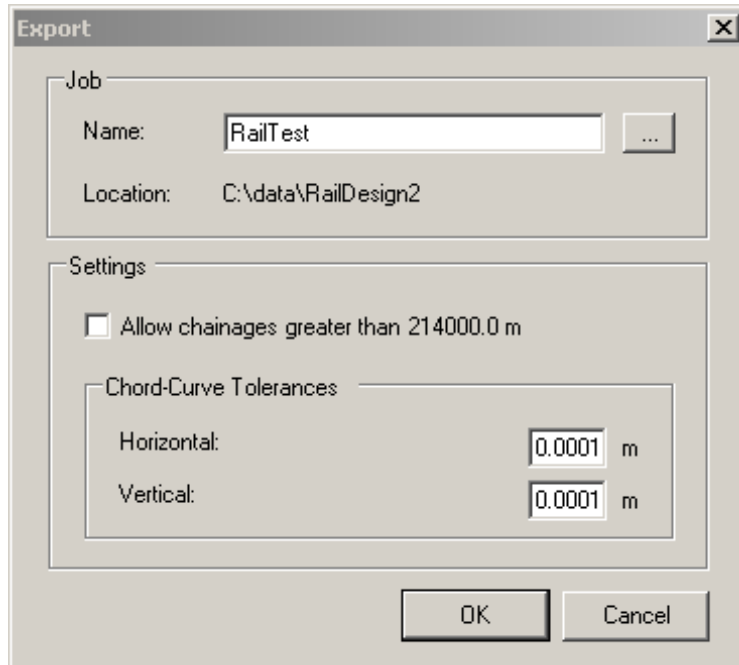

Click **OK** to create the files for onboard use. The database files are created and are located in the same folder as the source alignment files.



Refer to the Design to Field User Manual for details on importing various types of data with various field importers. This manual is included in the Design to Field Converters install application RR_Design_to_Field.exe, which can be downloaded.

46.1.4

Loading the Track Design onto the Instrument

Loading the design

Once the track design has been converted, copy all the database files to the \DBX folder of the data storage device of the instrument. Refer to "B Directory Structure of the Memory Device".

46.2

Defining the Work

Access

1. Select **Leica Captivate - Home: Stake rail** or **Check rail**.
2. In the job selection panel, select the required jobs. Refer to "6.3 Choosing a Job".
3. Press **OK**.

Task

Key	Description
OK	To continue to the next panel.
Fn Settings	To configure the app. Refer to "43.3 Configuring Roads Apps".

Description of the methods

Method	Description
Track	To stake the track geometry using a pole.
Track & gauge device	To stake the track geometry using a gauge device. When a measurement is made, the values are retrieved from the gauge device. The current track geometry is checked against the theoretical track geometry. The current track geometry includes both rail position, gauge and cant.
Rails & gauge device	Available for Check rail only. This method does not take into account any rail design and is not intended to check the absolute positioning of the rails. However, the current position can be recorded. Chainages are only used, if the gauge device provides them from the odometer.

Next step

OK accesses the **Define Task** panel.

Define

The screenshot shows the 'Define' panel with the following settings:



- Layer: Rechtes Gleis
- Chainage line: Centerline
- Working chainage: 140.000 m
- Working line: Centreline

At the bottom of the panel, there is an 'OK' button.

Key	Description
OK	To continue to the next panel.
Shifts	To apply horizontal and vertical shifts to the selected element. Refer to "43.4 Working with Shifts".
Load	To load a task. Refer to "43.5 Tasks".
Save task	To save the settings as a task. Refer to "43.5 Tasks".
Fn Settings	To configure the app. Refer to "43.3 Configuring Roads Apps".

Description of fields

Field	Option	Description
Layer	Display only or selectable list	Layers contained in the active rail job can be selected, for example layer of left or right track design.
Chainage line	Display only	Shows the name of the chainage line, at the selected layer.

Field	Option	Description
Working chainage	Editable field	Available for Stake: Track . To enter a chainage of the chainage centreline. The chainage must range between the start chainage and end chainage. The default is the setup point for TS and the current position for GS. Only those elements which appear at the chainage can then be selected from Working line .
Working line		Available for Stake: Track . The measured point values can be compared with the left rail, the right rail or the track centreline. The selectable list allows the selection of the line with which measured values are then compared.
	Centreline	The track centreline.
	Left rail or Right rail	<ul style="list-style-type: none"> For design data including the rails: Working with design data including the rails, the horizontal and vertical alignment of the design is used. Depending on the rail design settings, the superelevation of the design or the manually defined superelevation can be used. For design data without rails (only track centreline): If the design data does not contain the rail design, then the position of the left rail is calculated. The nominal gauge entered in the settings is used for the calculation. When working with horizontal alignments only: The height of the rails is calculated by using the values for Manual super-elevation definition defined on Stake Track  page/Check Track,  page.
Director rail	Selectable list	Available for Stake: Track & gauge device . The reference point for the delta values. The delta values displayed in the middle of 3D viewer refer to this selection.
Chainage increment	Selectable list	Available for Stake: Track & gauge device and Stake: Rails & gauge device . Determines the left/right rule the information is displayed. Distance in direction of increasing chainage = positive. The selection influences the geometry of the track in 3D viewer.
Position of the gauge sensor	Selectable list	Available for Stake: Track & gauge device and Stake: Rails & gauge device . The location of the mobile part of the gauge device.

Field	Option	Description
Start chainage for the odometer	Editable field	Available for Stake: Rails & gauge device . Relevant if the gauge device includes an odometer. Otherwise leave value to 0.00.

46.3

Staking/Checking the Track

46.3.1

The Stake/Check Panel

Staking points

It is possible to stakeout points using a rail job with and without a stored rail design.

When the position of the rails is not stored in the rail job, it is possible to stake out:

- The horizontal and vertical alignment of the track centreline
- Points with a known horizontal and vertical offset from the horizontal and vertical alignment of track centreline
- The rails of the track by entering the track superelevation, superelevation base and nominal gauge
- Points with known horizontal and vertical offsets from the manually defined rails.



When the position of the rails is stored in the rail job, it is possible to stake out:

- The horizontal and vertical alignment of track centreline
- Points with a known horizontal and vertical offset from the horizontal and vertical alignment of track centreline
- The rails of the track
- Points with known horizontal and vertical offsets from the defined rails.

Checking points

Besides checking points, it is also possible to work with cants (superelevation):

- The cant value can be entered manually. The value is measured using a device to measure the cant with an inclination sensor (camber measurement instrument).
- The difference of the manually entered cant value and the current design cant can be displayed on  page and is stored in the DBX.
- The cant value can be measured by using the option **Second point of super-elevation** of the toolbox. A second point on the track is measured to calculate the cant using the measured height difference and the configured superelevation base.

Stake Track,
 page,
 Check Track,
 page



Information regarding the measured point can be entered. This panel allows any point of the track to be checked against design values.



Key	Description
Measure	For GS: To start measuring the point being staked. The key changes to Stop . For TS: To measure a distance and store distance and angles.
Stop	For GS: To end measuring the point being staked. When Automatically stop point measurement is checked in GS Quality Control, General page recording of positions ends automatically as defined by the stop criteria. The key changes to Store . After ending the measurements, the differences between the measured point and the point to be staked are displayed.
Store	For GS: To store the measured point. When Automatically store point is checked in GS Quality Control, General page, the measured point is stored automatically. The key changes to Measure . For TS: To store angles and distance. Distance must be measured before.
Distance	For TS: To measure a distance.
Ch -	Available for Stake rail . To decrease the chainage as defined by Chainage increment .
Ch +	Available for Stake rail . To increase the chainage as defined by Chainage increment .
Page	To change to another page on this panel.
Fn Settings	To configure the app. Refer to "43.3 Configuring Roads Apps".
Fn Position	For TS: To position the TS to the defined stakeout point, including defined offsets. The settings for Rail Settings in Road Settings, TS specific page, apply. Refer to "Road Settings, TS specific page".
Fn Tools	To access the toolbox. Refer to "46.4 The Toolbox".

Description of fields

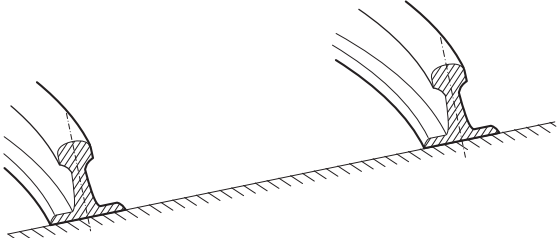
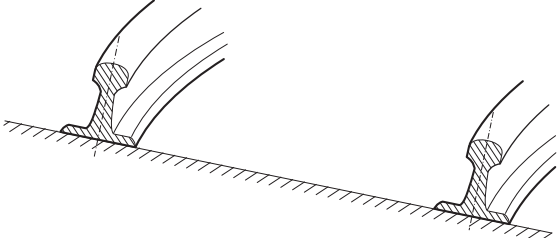
Field	Option	Description
Point ID	Editable field	Name of the next point to be stored. The ID is incremented/decremented whenever a point gets stored.
Antenna height	Editable field	For GS: Height of the antenna.
Antenna height	Editable field	For GS: Perpendicular height of the antenna. Available when the perpendicular height is configured. Refer to " Road Settings,Rail design page".
Target height	Editable field	For TS: Height of the prism. Using a gauge device, the target height is always applied perpendicular. In this case, the setting for Apply target height in Rail Settings, Rail design page is ignored.
Perpendicular target ht	Editable field	For TS: Perpendicular height of the prism. Available when the perpendicular height is configured. Refer to " Road Settings,Rail design page".
Stake chainage	Editable field	The defined chainage of the point to be staked out. For multiple tracks that have a defined chainage centreline, the chainage to be staked out always refers to the chainage of the chainage centreline, not to the chainage of the track centreline.
Chainage increment	Editable field	Value by which the nominal chainage increases/decreases when pressing Ch -/Ch + . To stake a point at more than one chainage, define a chainage increment.
Allow entering the measured super-elevation	Check box	When this box is checked, the cant value (superelevation) which was measured with an inclination sensor can be entered manually. The difference of the manually entered cant value and the current design cant is displayed on  page. When this box is not checked, no cant difference (superelevation) is calculated of the current design cant and the measured cant. The current cant can be measured using the option Second point of super-elevation from the toolbox.
Measured super-elevation	Editable field	Available when Allow entering the measured super-elevation is checked. Positive or negative signs must be entered. Seen in increasing chainage direction:

Field	Option	Description
		<ul style="list-style-type: none"> Negative cant value (example: -0.1900 m)  <p style="text-align: center;"><small>Rail.017</small></p>
		<ul style="list-style-type: none"> Positive cant value (example: 0.1900 m)  <p style="text-align: center;"><small>Rail.018</small></p>
		<p> When Second Point of the tool-box is active, the current cant value is used for the cant difference calculation, not the value for Measured super-elevation.</p>
Manual super-elevation definition	Display only	This field and the following fields are available for Use super-elevation: Enter manually in Rail Settings, Rail design page.
Height of lower rail	Editable field	Defines the absolute height of the lowest rail at the defined chainage.
Super-elevation left	Editable field	Defines the superelevation at the left rail. <ul style="list-style-type: none"> When working with horizontal alignments only: If the superelevation is rotated around the left rail, the superelevation would be zero. When working with horizontal and vertical alignments: If the track is rotated around the left rail, the vertical alignment would coincide with the left rail and the superelevation would thus be zero.

Field	Option	Description
Super-elevation right	Editable field	<p>Defines the superelevation at the right rail.</p> <ul style="list-style-type: none"> When working with horizontal alignments only: If the track is rotated around the right rail, the superelevation would be zero. The total superelevation (left + right) is applied across the distance defined as the superelevation base in the settings. When working with horizontal and vertical alignments: If the track is rotated around the right rail, the vertical alignment would coincide with the right rail and the superelevation would thus be zero. The total superelevation (left + right) is applied across the distance defined as the superelevation base in the settings.

Next step

Page changes to the  page.

**Stake Track/
Check Track,
 page**

Refer to "Stake Track,page,Check Track,page" for a description of keys.

Description of fields

Field	Option	Description
Use offsets	Check box	<p>When this box is checked, offsets can be typed in.</p> <p>Often it is necessary to stake out points with a fixed plan offset and fixed height offset from a known reference line (track centreline or rail).</p> <p>Offsets are applied in the same way, irrespective of how the rail design has been entered, whether the offsets are manually entered or if library offsets are used. The sign of the offsets conforms to the offset sign convention described in "43.6.12 Rail - Working with Offsets".</p>

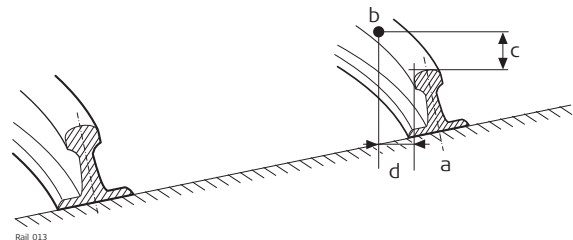

Field	Option	Description
		<ul style="list-style-type: none"> a Reference line (right rail) b Point to stake c Height offset d Offset
Offsets	Manual	Offsets can be entered in Offset/Check offset or Height offset/Check height diff .
	From library	The offset is stored as part of the rail job and recalled whenever required.
Offsets	Selectable list	Available for Offsets: From library . The point ID of the stored stake offsets. To select a different stored offset or to create a point, highlight this field and open the selectable list. Refer to "46.3.2 Offset Library".
Offset	Editable field	Available for Stake. Horizontal offset applied to the position of the reference line as defined by the design data or as calculated from manually entered data using the nominal gauge.
Height offset	Editable field	Available for Stake. Vertical offset applied to the height of the reference line as defined by the design data or as calculated from manually entered data using the superelevation and superelevation base.
Offset	Editable field	Available for Check. Horizontal offset applied to the position of the reference line as defined by the design data or as calculated using manually entered data using the nominal gauge.
Check height diff	Editable field	Available for Check. Vertical offset applied to the height of the reference line as defined by the design data or as calculated from manually entered data using the superelevation and superelevation base.
Use pendular displacement	Check box	<p>This functionality is used in railway tunnels. The functionality is available for Stake rail and Check rail.</p> <p>Some rail projects require extra pendular displacement calculation for the design axis.</p> <p>The track is rotated based on a line with a defined height offset (pendulum length) from the track centreline. This action defines a horizontal displacement for the track. The vertical alignment is independent from the pendular displacement and does not change.</p> <p> The pendular displacement calculation only influences the horizontal position of the design axis. It does not change the height of the track.</p>

Field	Option	Description
-------	--------	-------------

When this box is checked, a pendulum length can be entered. From the original track definition, a pendulum centre is defined exactly above the axis point. The difference in elevation of the pendulum centre is the pendulum length. With the help of the superelevation, a displacement is calculated. The effect of the pendular displacement is displayed on the  page.

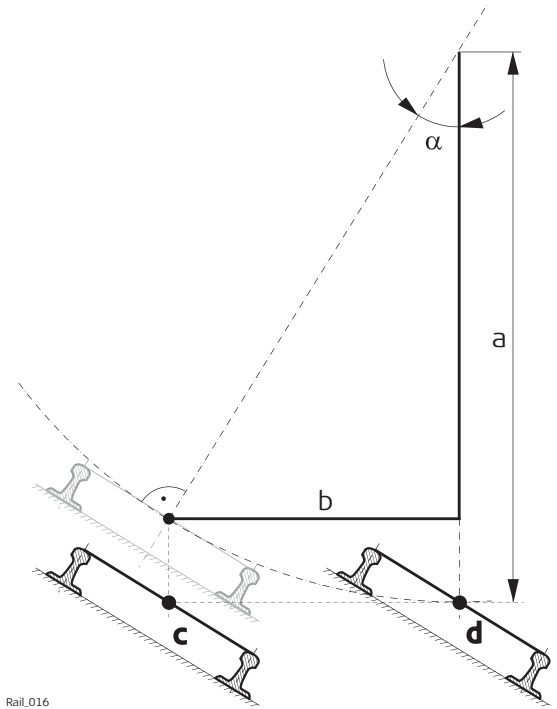

Rail_016

- a Pendulum length: The difference in elevation of the pendulum centre on the original track and above the axis point
- b Resulting pendular displacement
- c Displaced design axis based on pendular displacement calculation
- d Design axis defined in horizontal alignment
- α Pendulum angle

Pendular length	Editable field	Available when Use pendular displacement is checked. The pendulum length as distance value. Positive values (0 - 9999.9999) point upwards. Negative values are not allowed.
------------------------	----------------	--

Next step

Page changes to the next page.

Stake Line

 This page is available for Stake rail only.



This page displays the differences between the measured point and the defined point. The position of the point to stake is reached when all difference values are close to zero.

The chainage can be de-/incremented by pressing left/right arrow key. The defined value for chainage increment is applied.

Refer to "Stake Track,page,Check Track,page" for a description of keys.

Refer to "51.4 Staking Out" for a description of the elements of the graphical display.

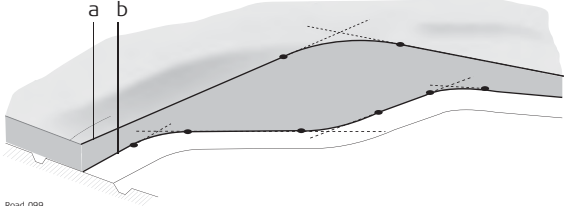
Description of fields

Field	Option	Description
Chainage	Display only	The current track chainage.
CL offset	Display only	Perpendicular horizontal offset from the centreline.
Difference in chainage	Display only	Difference between the defined Stake chainage and the current chainage Chainage of the measured position. If no defined chainage exists, for example if staking out random chainages or checking, this field shows -----.
Nearest hz tangent point	Display only	The chainage difference between the measured point and the nearest tangent point of the design is displayed. The nearest tangent point is the start/end point of a road segment.
		
<p>a Vertical alignment b Horizontal alignment</p> <p>Only tangent points are detected. A tangent point is the start/end point of a road segment.</p>		
Difference in offset	Display only	Horizontal offset between the defined position and the current position. The Offset defined on the  page is taken into account.
Difference in height	Display only	Vertical offset between the defined position and the current position. The Height offset defined on the  page is taken into account.

Next step

Page changes to the  page.

Stake Track/ Check Track, i page

The **i** page displays the differences between the measured and design data. The fields viewed on this page can be configured in **Rail Settings, Info** page. Refer to "Road Settings,Info page" for information on all available items for the **i** page and how to select them.

Stake Track/ Check Track, 3D viewer

3D viewer displays a plot of the measured point related to the track design. The design is defined by the selected rail or track centreline, and the values entered on the **Measure/View** page.

3D viewer for Check and Stake are similar. The only difference is that the current chainage is always shown, as shown on the **i** page.

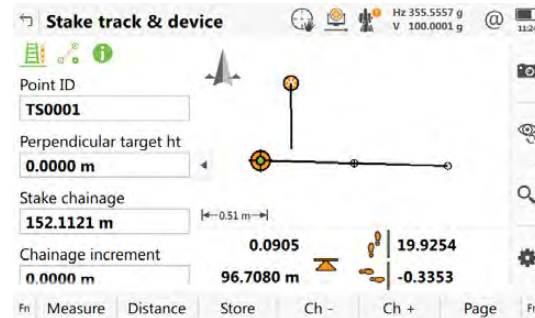

For Stake, extra information is shown at the bottom:

1. Difference in chainage is shown with some footsteps
2. Horizontal offset is shown with some footsteps
3. Height difference is shown as an arrow
4. Current height
5. The element to stake is shown as an orange and green dot
6. The plot can be shown as profile view, plan view, orbital view and navigation view.

For measurements with Stake: Track & gauge device:

The cross section view shows the geometry of the track design with two pegs in each of the rails. The current geometry retrieved from the gauge device is displayed in grey.

In the upper edges of the panel, the values referring to the left and right rails are displayed on each of the sides.

At the top, the **Director rail offset difference** and **Difference in gauge** values related to the rail director are presented.

For measurements with Stake: Rails & gauge device:

The cross section view shows the geometry of the track resulting from the gauge device measurements.

At the top, the chainage, gauge and cant values retrieved from the gauge device are displayed.

46.3.2

Offset Library

Description

To select a different stored offset or to create a new point.

Access step-by-step

1. In **Stake Track/Check track**,  page, select **Offsets: From library**.
2. Highlight **Offset ID** and open the selectable list.

Offset library

Display of information about the reference rail or the offset and the height difference.

This panel allows offsets relative to a reference line to be defined and stored in the rail job. These points can be recalled at any time.

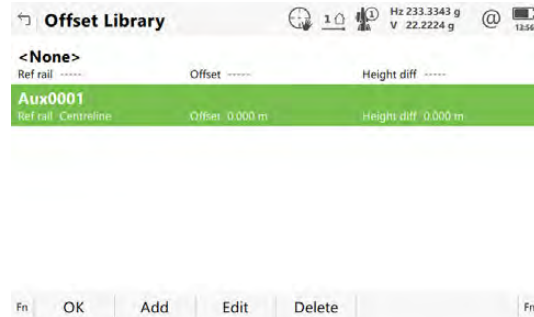

Key	Description
OK	To select a defined offset and to continue.
Add	To enter an offset.
Edit	To edit an existing offset.
Delete	To delete an existing offset.

Next step

Press **Add** or **Edit**.

Job name, Offsets

This panel allows the values of the stake/check offsets to be entered/edited. In addition to the horizontal and vertical offsets, an offset name (point ID) can be entered for each item.

Next step

Press **OK** twice to return to **Stake Track/Check track**.

46.3.3

Working with Pendular Displacements

Requirements

In **Stake Track/Check Track**,  page, check **Use pendular displacement** and type in a value for **Pendular length**.

Specific values on the page

Value	Description
Pendular length	The defined pendulum length as entered on  page.

Value	Description
Def pendulum displacement	Resulting horizontal displacement at defined chainage.
Actual pendulum displacement	Resulting horizontal displacement at current chainage.
Def pendulum angle	Resulting pendulum angle at defined chainage.
Actual pendulum angle	Resulting pendulum angle at current chainage.

46.4

The Toolbox

46.4.1

Overview

Access

Press **Fn Tools** on any page of the Stake/Check panel.

Description

Additional functions for staking/checking the track can be accessed through the toolbox. This functionality is additional to those already existing functions which are available via the function keys.

The functionality differs between the stake and check methods. Refer to these subchapters for a detailed description of the functionalities:

- "46.4.2 Use heights from DTM"
- "46.4.3 Apply current chainage"
- "46.4.4 Stake individual point"
- "46.4.5 Second point of super-elevation"
- "46.4.6 COGO Rail"

46.4.2

Use heights from DTM

Availability

This menu function is available for stake and check.

Description

The app offers the possibility to



- switch to a height which is retrieved from an existing height layer, as defined in the selected DTM job. The layer from the DTM is applied and used as a height reference for the staking out or checking of alignments.
- retrieve heights from an existing layer, as defined in the DTM job associated with the project. The DTM used is not considered for the stake values. Three new information lines are added to the **i** page: **DTM height diff**, **DTM height** and **DTM layer**.
- show the DTM triangles in the planar view and in the cross section view in 3D viewer.

Once defined, each layer remains active until it is turned off. DTM heights can be used for both 2D and 3D alignments.

Use Heights From DTM

Key	Description
OK	To confirm the settings and return to the Stake/Check panel.

Description of fields

Field	Option	Description
DTM	Display only	DTM from the selected DTM job.
DTM layer	Selectable list	When selecting a DTM layer the relevant triangle of the DTM is shown in 3D viewer.
Use DTM height for stake out	Check box	When this box is checked, a layer of the DTM is used as a height reference. When this box is not checked, no DTM heights are applied for stakeout or check.
Show DTM height difference on Info page tab	Check box	When this box is checked, a layer of the DTM to be used as a height reference on the  page. When this box is not checked, no additional height information relative to the DTM is shown on the  page.
DTM layer	Selectable list	Available when Show DTM height difference on Info page tab is checked. Layer of the DTM to be used as a height reference. When selecting a DTM layer the relevant triangle of the DTM is shown in cross section view in 3D viewer.

46.4.3

Apply current chainage

Availability

This menu function is available for stake.

Description

To set **Stake chainage** on the  page of the stakeout to the current chainage.

46.4.4

Stake individual point

Availability

This menu function is available for stake.

Description

To stake out points with known Easting, Northing and Height. Points can either be selected from the job or manually typed in.

If a design job has been selected, a point from the design job can be selected. When staking out/checking an individual point, the selected point is set in relation to the alignment and all line relevant values are calculated and displayed.

The **Stake chainage** and **Offset** of the Stake panel are calculated based on the coordinates of the selected point.

 If the chosen point has no height the design height is used. If the point has a height it is possible to use that one or continue working with the design height.

46.4.5

Second point of super-elevation

Availability

This menu function is only available for check.

Description

To determine the current cant of two rails.

In order to calculate the current cant, it is necessary to measure two points, one on each rail. A mechanical device can be used to measure these points if necessary.

Additionally, the current cant can be calculated by first measuring any two points (example, the track centreline and lower rail) and then using the super-elevation base. The calculation is dependent upon the superelevation base.



When **Second point of super-elevation** is active, the **Current super-elevation** is used for the calculation of the cant difference, not the measured cant value from a cant device as seen in **Check Track**,  page.

Diagram

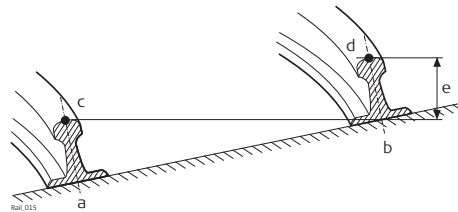

- a Left rail
- b Right rail
- c first point
- d Second point of cant
- e Current cant

Procedure

Measuring the first point

The first point can be measured directly from the **Check Track** panel.

Measuring the second point

The second point is measured after accessing the **Second point of super-elevation** in the toolbox. Once the second point has been measured, the value **Current super-elevation** is displayed on the  page.

46.4.6

COGO Rail



The functionality of COGO Rail is identical with COGO Road. Refer to "45.4.6 COGO Road - Alignment info".

Downloads section

The tunnel design data is imported for use onboard the instrument using

- the industry standard LandXML data format
- formats exported from some other design packages using the Design to Field component of the Infinity computer application.

Converters are available for more than 15 different design packages.



The latest version of the Design to Field importers can be found in the downloads section of:

- myWorld@Leica Geosystems
<https://myworld.leica-geosystems.com>

Basics

The tunnel centreline is defined in two or three dimensions. If design profiles are to be used, a three-dimensional centreline is required.

Design to field

1. To import a centreline using the Design to Field component select the **Tools/Design to Field** option of the Infinity computer application.



- 2.

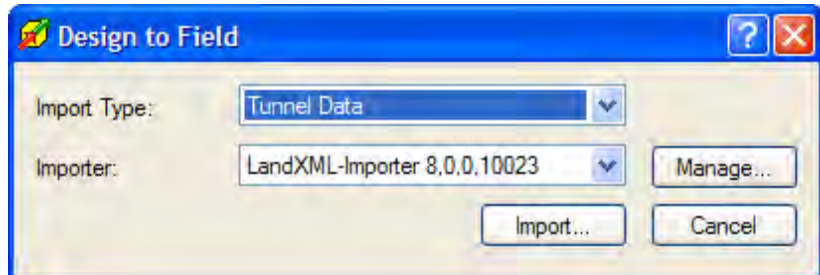

For general information about Design to Field, please refer to the Infinity manual or Online Help.

Tunnel design profiles

If tunnel design profiles are available, they are created using the Tunnel Profile Editor computer application. This application is integrated in the Design to Field viewer. It allows users to import or create tunnel data like profiles, layers and rotations. Refer to the Tunnel Profile Editor online help for more information.

Tunnel Profile Editor, Profile details view

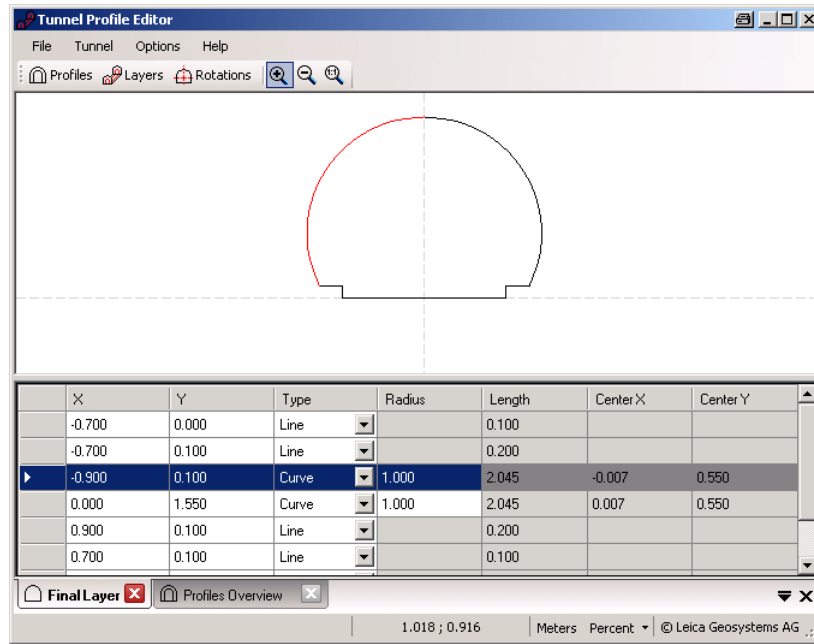

Tunnel Profile Editor, Layer details view

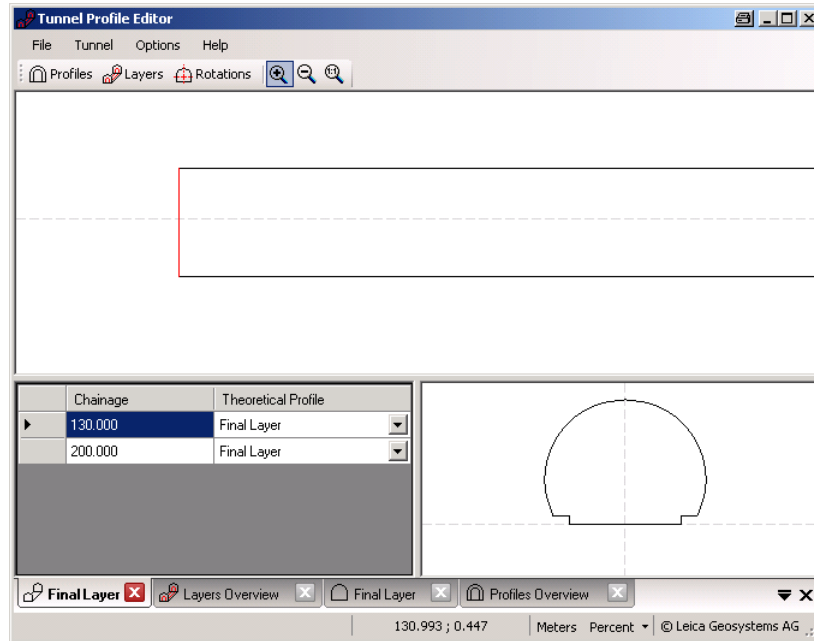

Vertical or perpendicular profiles

The Tunnel Profile Editor allows users to define tunnel profiles vertically or perpendicular to the vertical alignment of the tunnel axis. This results in different tunnel sizes for equal profile definitions as shown in the graphic.

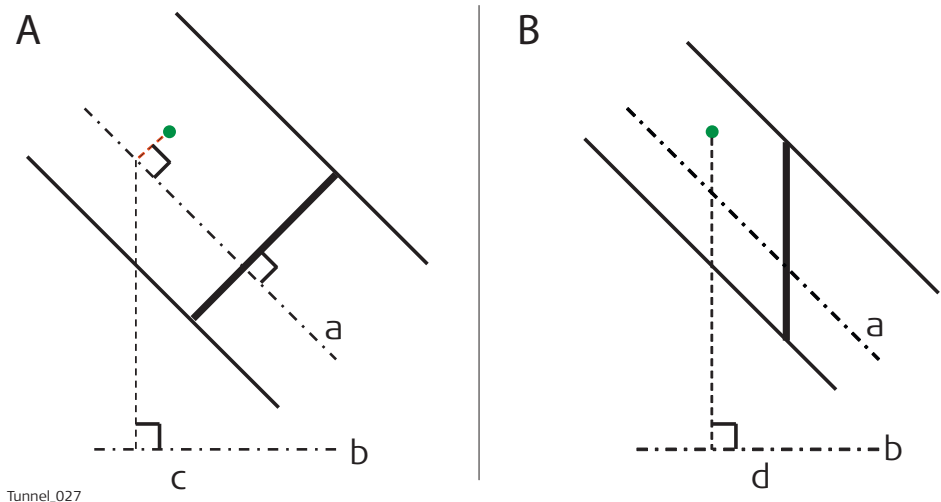

Tunnel_027

- A Perpendicular (tilted) profile
- B Vertical profile
- a Vertical alignment of tunnel axis
- b Horizontal alignment of tunnel axis
- c Chainage for perpendicular profile definition
- d Chainage for vertical profile definition

47.1.4

Data Transfer to Instrument

Getting data onboard

Once the design data have been converted, copy the database files to the DBX folder of the data storage device that is used on the instrument. The file names are jobname.x**.

47.2

Defining the Work

Access

Select **Leica Captivate - Home: Stake tunnel** or **Check tunnel**.

Task



Key	Description
OK	To continue to the next panel.
Fn Settings	To configure the app. Refer to "43.3 Configuring Roads Apps".

Description of the methods

Method	Description
Tunnel face	Stakeout the tunnel face at a defined chainage. Design information is defined relative to the centreline or the tunnel profile.
Tunnel profile	Stakeout tunnel profiles at a defined chainage. Design information is defined relative to the centreline or the tunnel profile.
Profile by measuring	Check tunnel profiles, by measuring deviations to the design. Design information is defined relative to the centreline or the tunnel profile.
Profile by scanning	Check tunnel profiles, by automatically scanning at defined chainages to measure deviations to the design. Design information is defined relative to the centreline or the tunnel profile.
Profile generator	Extract as-built tunnel profiles from scanned point clouds and check deviations to the tunnel design.

Next step

OK accesses the **Define** panel.

Select Scans To Use

Available for **Check: Profile generator**.

Check the box in front of a scan ID to select a scan to use.

Uncheck the box in front of a scan ID to deselect a scan.

Key	Description
OK	To continue to the next panel.

Define

The panel is an example valid for **Stake: Stake face**.

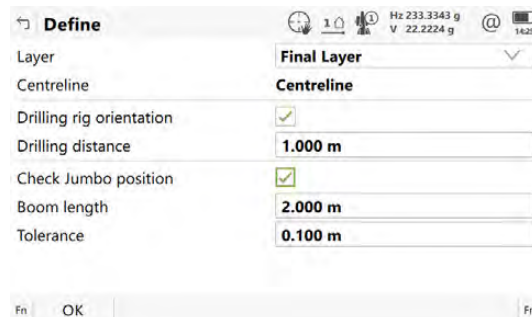

Key	Description
OK	To continue to the next panel.
Shifts	To apply horizontal, vertical and profile shifts to the selected element. Refer to "43.4 Working with Shifts".
Load	To load a task. Refer to "43.5 Tasks".
Save task	To save the settings as task. Refer to "43.5 Tasks".

Key	Description
Fn Settings	To configure the app. Refer to "43.3 Configuring Roads Apps".

Description of fields

Common to all methods

Field	Option	Description
Layer	Display only or selectable list	Layers contained in the active tunnel job can be selected.
Centreline	Display only	The name of the layer centreline.

For **Tunnel face**

Field	Option	Description
Drilling rig orientation	Check box	This functionality helps to orientate the drilling rig when drilling holes parallel to the tunnel axis direction. The entry point at the tunnel face is marked and delta angles to align the drilling rig are provided.

The following fields are available when **Drilling rig orientation: Parallel to alignment** is selected in **Tunnel Settings, Tunnel design** page:

Drilling distance	Editable field	The bore hole length. Available when Drilling rig orientation is checked and used to calculate the direction parallel to the alignment.
Check Jumbo position	Check box	When this box is checked, the jumbo position is checked after measuring to the back of the boom.
Boom length	Editable field	The length of the boom is used for calculating and checking the jumbo position when Check Jumbo position is checked.
Tolerance	Editable field	Defines how accurately the boom must be positioned to calculate the delta angles (max 10% of boom length). Available when Check Jumbo position is checked.

The following fields are available when **Drilling rig orientation: Drill Pattern** is selected in **Tunnel Settings, Tunnel design** page:

Apply drill pattern from	Meas chainage	The drill pattern is directly applied to the measured chainage. To acquire the measured chainage, take a measurement, press Fn Tools and select Apply current chainage .
	Defined Chainage	This chainage is typed manually into the Stake chainage editable field. It is used to calculate the corresponding position and drill direction at the measured chainage.

For **Profile by measuring**

Field	Option	Description
Apply target radius	Check box	<p>When using a prism to check a design profile, it is important to take the prism radius into account.</p> <p>The measured point is projected by a distance equivalent to the radius of the prism in a direction perpendicular to the tangent of the design profile.</p> <p>When this box is not checked, the design profile is compared to the coordinates of the centre of the prism at the measured position.</p>
Target radius	Editable field	<p>Available when Apply target radius is checked. The radius of the prism.</p>

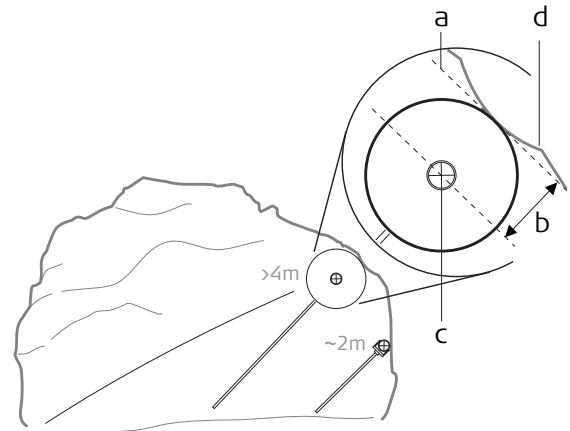

- a Tangent to design profile
- b Prism radius
- c Prism
- d Design profile

If measurements to any surface are used or no design profile has been defined, the prism radius parameter is not used in the calculation.

In 3D viewer, a plot of the measured point regarding the design profile is displayed.



For **Profile by scanning**

Field	Option	Description
Define a scan task	Scan whole profile	Each profile is scanned 360°/400 gon.
	Scan segment	The tunnel profile can be split into user-defined segments. Each segment can be assigned as a scan segment or non scan segment.

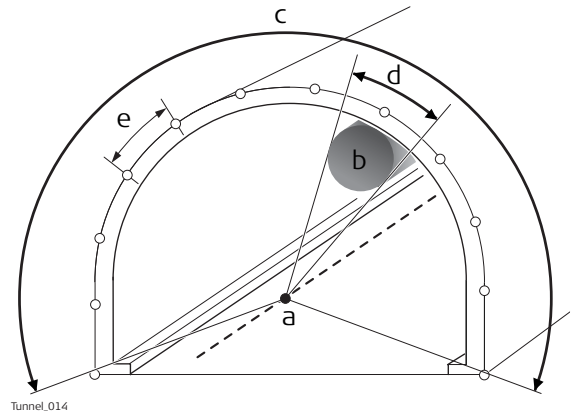
Field	Option	Description
-------	--------	-------------



- a Instrument axis
- b Ventilation shaft
- c Scan segment, included
- d Scan segment, excluded
- e Scan interval

Scan interval	Editable fields	Available for Define a scan task: Scan whole profile . Defines at what interval to measure a point around the profile.
Scan Mode	Accuracy optimised Speed optimised Quick profiler	<p>This measurement mode is accuracy and range optimized. It uses single distance measurements to any surface.</p> <p>This measurement mode is speed and performance optimized. It uses continuous distance measurements to any surface.</p> <p>It uses continuous distance measurements to any surface. Stores the measured data once the whole profile has been scanned or the scan is paused.</p> <p> The Quick profiler mode does not store TS observations.</p>
TS handle is attached	Check box	<p>When this box is checked, scanning a segment above the instrument is excluded automatically. The TS handle would otherwise interfere with measurements.</p> <p> If scanning at the station chainage, then the scan does not include the profile segment beneath the total station.</p>
Radio handle type	Normal handle Radio handle	<p>If this option is selected, then it is not scanned between 386 gon and 7 gon.</p> <p>If this option is selected, then it is not scanned between 380 gon and 25 gon.</p>

For **Profile generator**

Field	Option	Description
Start chainage	Editable field	Chainage of the first profile to check.
End chainage	Editable field	Chainage of the last profile to check.
Profiles interval	Editable field	Distance between a pair of consecutive checked profiles.

47.3

Staking/Checking the Tunnel

47.3.1

Overview

Stake Face/
Stake Profile,
page,
Check Profile,
page

This panel is an example valid for **Stake: Stake profile**.



Key	Description
Measure	To measure a distance and store distance and angles.
Distance	To measure a distance.
Store	To store angles and distance. Distance must be measured before.
Ch -	Available for Stake tunnel . To decrease the chainage as defined by Chainage increment .
Profile +	To increase the distance along the profile. Available for Offset method: Profile, dist & offset and Offset method: Dist from top&offset .
Ch +	Available for Stake tunnel . To increase the chainage as defined by Chainage increment .
Page	To change to another page on this panel.
Fn Settings	To configure the app. Refer to "43.3 Configuring Roads Apps".
Fn Position	Available for Stake tunnel . To stake the point automatically. The instrument aims toward the point at the given chainage and offsets and measures a distance. If this distance is not within the required tolerance an iterative process is started until: <ul style="list-style-type: none"> the number of iterations set as the parameter Maximum iterations is reached, or the difference between the measured point and the design point is less than the value set as the parameter Position limit.

Key	Description
Fn Tools	Available for Stake tunnel . To access the toolbox. Refer to "47.4 The Toolbox".

Description of fields

Field	Option	Description
Point ID	Editable field	The point identifier of the point to be staked.
Stake chainage	Editable field	Available for Stake tunnel . The defined or approximate chainage of the point to be staked out.
Chainage increment	Editable field	Available for Stake: Stake profile . Chainage increment. Value by which the nominal chainage increases/decreases when pressing Ch +/Ch - . Define a chainage increment for points staked at more than one chainage.
Target height	Editable field	Available for Stake: Check profile . The height of the prism. If a prism is used, type in the vertical difference between the point to be measured and the point of the prism pole.

Next step

Page changes to the **Offsets** page.

Scan Profile, Scan area page

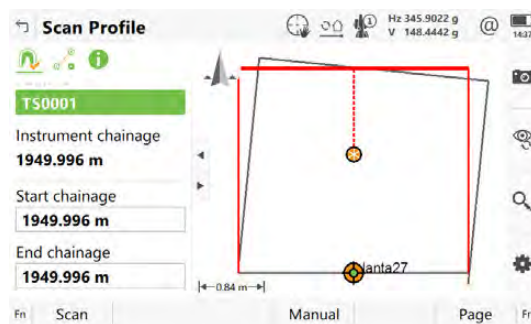

Key	Description
Scan	Available for automatic scanning. To start the scanning process. Refer to "During a scan".
Stop	Available for automatic scanning. To stop the scanning process.
Pause	To pause the scan.
Resume	To restart scanning.
Get Ch	Point the telescope to the start or end chainage and press Get Ch to measure to the start/end chainage.
Measure	Available for manual scanning. To measure a distance and store distance and angles.

Key	Description
Distance	Available for manual scanning. To measure a distance.
Store	Available for manual scanning. To store angles and distance. Distance must be measured before.
Next point	To skip the point being measured and move onto the next profile point.
Profile +	To stop scanning the current profile and move onto the next profile.
Manual or Auto	To switch between manual and automatic scanning.
Page	To change to another page on this panel.
Fn Settings	To configure the app. Refer to "43.3 Configuring Roads Apps".
Fn Temp	To define a temporary scan interval. Until the temporary scan interval is disabled, all scan segments are scanned at the defined temporary scan interval.
Fn Tools	To access the toolbox. Refer to "47.4 The Toolbox".

Description of fields

Field	Option	Description
Point ID	Editable field	The point identifier of the point to be staked.
Instrument chainage	Editable field	The chainage of the instrument setup.
Start chainage and Start distance	Editable field	Enter/measure a chainage/distance value where scanning starts along the alignment. The start can be before or after the station chainage. If entering a distance value to indicate start scanning before the station chainage use a negative. If entering a distance value to indicate start scanning after the station chainage use positive.
End chainage and End distance	Editable field	Enter/measure a chainage/distance value where scanning ends along the alignment. The end can be before or after the station chainage. If entering a distance value to indicate end scanning before the station chainage use a negative. If entering a distance value to indicate end scanning after the station chainage use positive.
Before instrument	Editable field	If the scan area starts before the station chainage then define how often to scan a profile along the alignment from this chainage until the defined end chainage or station chainage. The chainage which ever comes first is used.

Field	Option	Description
After instrument	Editable field	If the scan area ends after the station chainage then define how often to scan a profile along the alignment from the station chainage or start chainage until the defined end chainage/distance. The chainage which as a greater chainage is used.

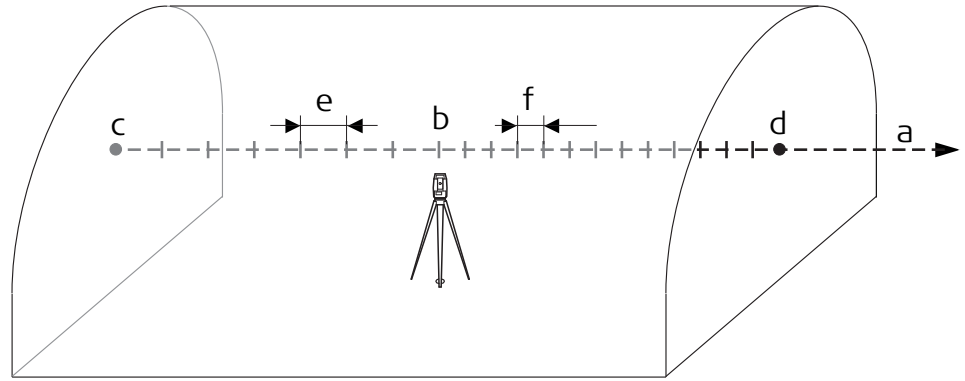

Tunnel_030

- a Alignment
- b **Instrument chainage**
- c **Start chainage** or **Start distance**
- d **End chainage** or **End distance**
- e **Before instrument**
- f **After instrument**

Next step

Page changes to the  page.

**Stake Face/
Stake Profile/
Check Profile/
Scan Profile,**
 page

Refer to "Stake Face/Stake Profile,page,Check Profile,page" for a description of keys.

Description of fields

Common for all methods

Field	Option	Description
Use offsets	Check box	When this box is checked, horizontal and vertical offsets can be applied.  For Scan Profile , the setting does not offset or expand/shrink the design profile.

For **Stake tunnel**

Field	Option	Description
Offset method		To define the position of the point to be staked out.

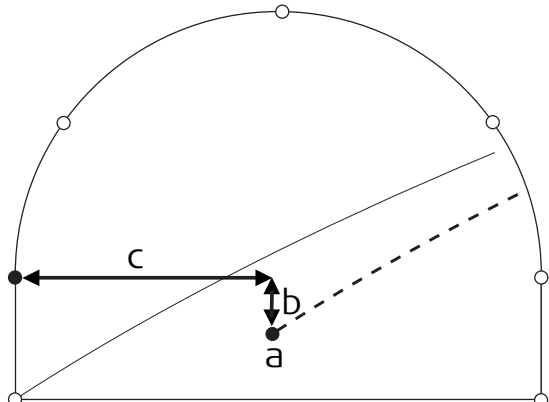
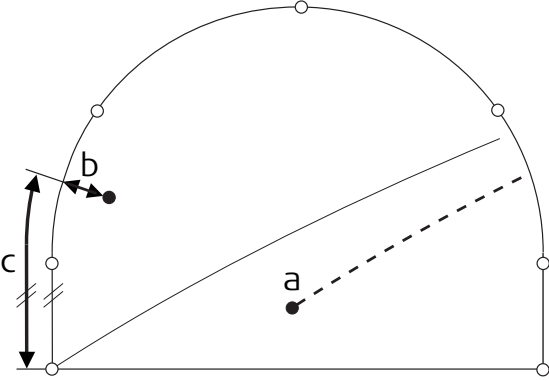
Field	Option	Description
	Offset & height	The point is staked out with a known perpendicular and vertical offset from the horizontal and vertical alignments respectively.
		 <p>Tunnel_018</p> <ul style="list-style-type: none"> a Centreline b Centreline height difference c Centreline offset
	Point from design	The offsets of the point are stored as coordinates in the Road design . The Offset is stored as the X coordinate and the Height offset is stored as the Y coordinate.
	Profile, dist & offset	The point is defined by the distance from the start of the profile and an offset perpendicular to the design profile.
		 <p>Tunnel_019</p> <ul style="list-style-type: none"> a Centreline b Profile offset c Distance from start of design profile
	Dist from top & offset	The point is defined by the distance from the top of the tunnel and an offset perpendicular to the design profile.

Field	Option	Description
-------	--------	-------------

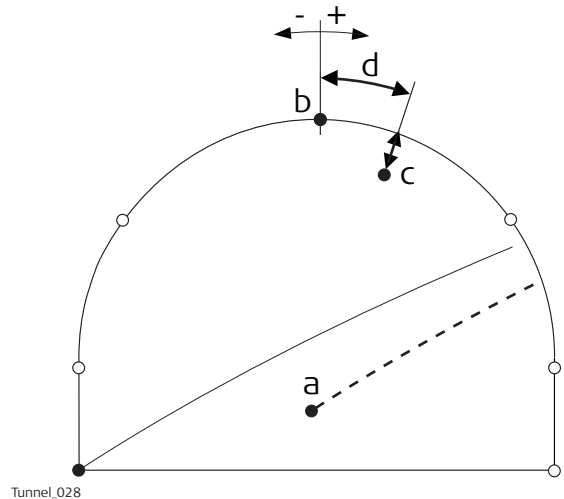

Tunnel_028

- a Centreline
- b Top of profile
- c Offset perpendicular to the profile segment
- d Distance from the top of the profile

Element & offset

The point to stake out is defined by:

1. The number of the element on which the point lies
2. The percentage of the distance along the element of the point to stake out
3. The offset perpendicular to the design profile.

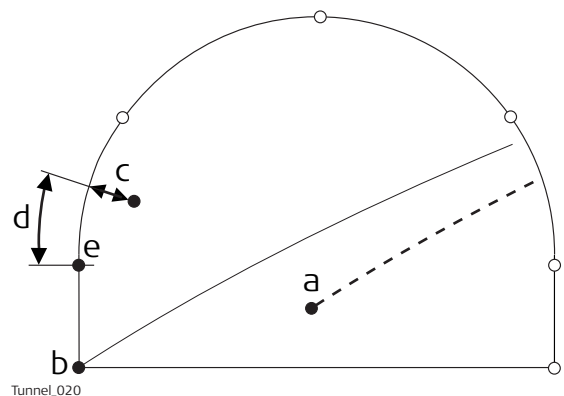

Tunnel_020

- a Centreline
- b Point defining start of design profile
- c Offset perpendicular to profile segment
- d Distance from start of start point of segment in %
- e Start point of segment

Offset	Editable field	Applies a horizontal offset perpendicular to the centreline. Available for Offset method: Offset & height.
---------------	----------------	---

Field	Option	Description
Height offset	Editable field	Applies a vertical offset to the centreline. Available for Offset method: Offset & height.
Point ID	Selectable list	Available for Offset method: Point from design.
Profile distance	Editable field	The distance from start of design profile. Available for Offset method: Profile, dist & offset.
Top distance	Editable field	The distance from the top of the tunnel. Available for Offset method: Dist from top&offset.
Profile offset	Editable field	The offset from the design profile. Available for Offset method: Profile, dist & offset, Offset method: Dist from top&offset and Offset method: Element & offset.
Profile increment	Editable field	To increment the distance for offset definitions as distance and offset. Available for Offset method: Profile, dist & offset and Offset method: Dist from top&offset.
Element number	Editable field	Element number 1 is the first element of the design profile. Available for Offset method: Element & offset.
% of element	Editable field	Distance in percentage terms of the measured point along the design profile element. Available for Offset method: Element & offset.
Check offset	Editable field	Available for Stake: Check profile. Applies a horizontal offset perpendicular to the centreline used for comparing to the measured point.
Check height diff	Editable field	Available for Stake: Check profile. Applies a vertical offset to the centreline used for comparing to the measured point.
Drill hz angle	Editable field	The horizontal direction 0 is along the centreline of the tunnel alignment.

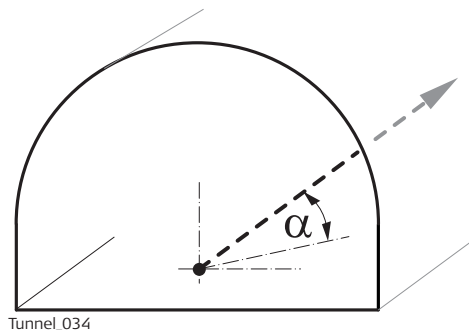

α **Drill hz angle**

Drill vertical angle	Editable field	The vertical direction 0 is along the centreline of the tunnel alignment.
-----------------------------	----------------	---

Field	Option	Description
-------	--------	-------------

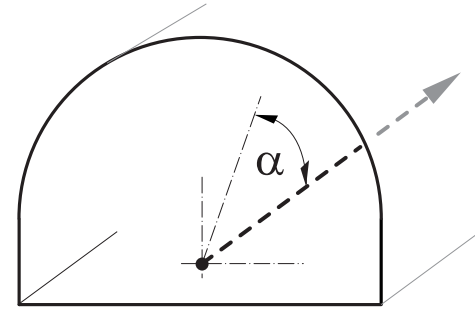

Tunnel_035

α Drill vertical angle

For **Check tunnel**

Field	Option	Description
Check off-set	Editable field	Applies a horizontal offset perpendicular to the centreline used for comparing to the measured point.
Check height diff	Editable field	Applies a vertical offset to the centreline used for comparing to the measured point.

Next step

Page changes to the next page.

Stake Face/ Stake Profile



This page is available for Stake tunnel only.

This page displays the differences between the measured point and the defined point. The position of the point to stake is reached when all difference values are close to zero.

Refer to "Stake Face/Stake Profile,page,Check Profile,page" for a description of keys.

Refer to "51.4 Staking Out" for a description of the elements of the graphical display.

Description of fields

Field	Option	Description
Chainage	Display only	The current chainage.
CL offset	Display only	Perpendicular horizontal offset from the centreline.
Nearest vertical tangent point	Display only	Distance to the nearest vertical tangent point of the design.

Next step

Page changes to the  page.

The **i** page displays the differences between the measured and design data. The fields viewed on this page are configurable. Refer to "43.3.10 Tunnel - Info Page - TS" for information on all available items for the **i** page and how to select them.

47.3.2

Stake face

Stake face

Overview

When excavating a tunnel, it is required to stake out the tunnel portal before excavation can begin. For excavation methods other than those involving tunnel boring machines (TBMs), it is required to stake out the tunnel face at given intervals during the excavation.

The tunnel face can be staked out at any time within the Tunnel app using **Stake face**.

This function allows the staking out of a series of points perpendicular to the horizontal alignment. The horizontal alignment indicates the position of the design profile at the chainage of the tunnel face.

Cross section view

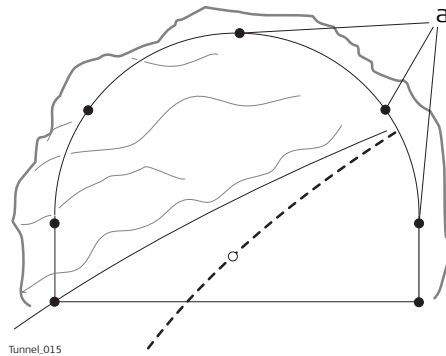

a Points to stake out

Given that it is likely that a degree of rock debris is present at the tunnel face or that inexact excavation techniques such as blasting are used, it cannot be assumed that the tunnel face at any stage of the excavation is perpendicular to the horizontal alignment.

This situation in turn implies that we cannot stake out a point on the tunnel face at a given chainage as the chainage of the tunnel face at any particular point is unknown. Iterative techniques are necessary to enable any defined point on the tunnel face to be staked out accurately.

The **Stake face** function involves setting out a point on the tunnel face at this unknown chainage. First of all the point to stake out on the tunnel face is staked out at an approximate chainage (e).

The point is defined by offsets regarding the centreline or by its position along the design profile and its offset from the profile. Given that the excavated tunnel face does not intersect the defined chainage, another point (e') is measured.

First iteration

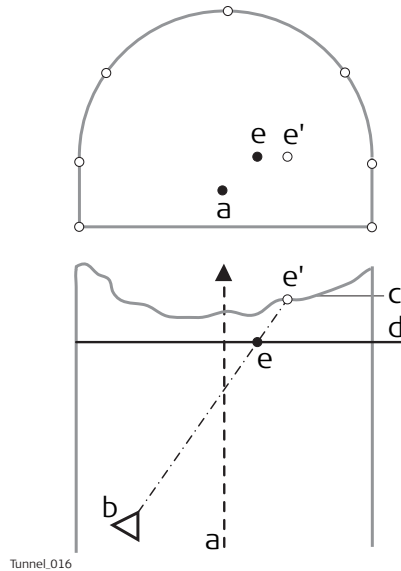

- a Centreline
- b Instrument position
- c Tunnel face
- d Approximate chainage to stake out
- e Point to stake out at approximate chainage
- e') Point to stake out on tunnel face

The true chainage of the measured point of the first iteration (e') is then calculated. The defined point (e) is staked out at the calculated chainage (d).

Second iteration

This process is repeated until the differences between staked point and the defined point are within a defined tolerance.

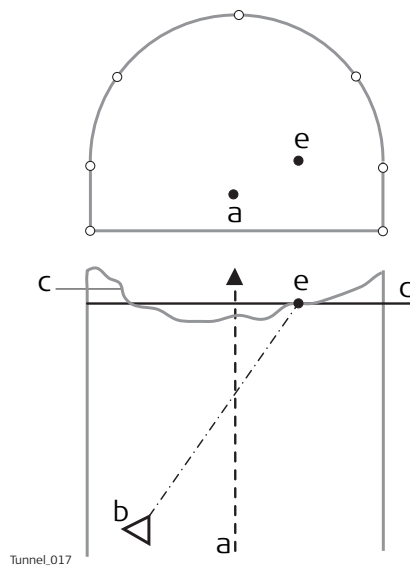

- a Centreline
- b Instrument position
- c Tunnel face
- d Calculated chainage from first iteration
- e Point to stake out at calculated chainage

Drilling rig orientation



Description

This functionality helps to orientate the drilling rig when drilling holes parallel to the tunnel axis or using a drilling pattern, that is manual entry of drill direction.

Drilling rig orientation step-by-step with Drilling rig orientation: Parallel to alignment

1. Make sure that **Stake tunnel** and **Stake: Stake face** is selected.
2. In **Tunnel Settings, Tunnel design** page, set **Drilling rig orientation: Parallel to alignment**. Refer to "Road Settings,Tunnel design page".
3. In the **Define** panel check **Check Jumbo position** and type in the values. Refer to "Defining the Work".
4. If **Drilling rig orientation: Parallel to alignment** was selected in **Tunnel Settings, Tunnel design** page and **Check Jumbo position** was checked in the **Define** panel, then proceed to define the drill entry position on the tunnel face by entering the respective centre-line offset in **Stake Face**,  page.
5. In **Stake Face, General** page, enter the approximate tunnel face chainage. To position the laser pointer to the drill entry point press **FnPosition** to find the point.
6. Position the drill bit to the laser point on the tunnel face.
7. Now the jumbo boom moves onto line between the laser point on wall and the telescope so that the laser now points at the back of the boom. Press **Fn Tools**. Select **Check Jumbo position** to get the delta angles which are used by the drilling rig to move the boom parallel to the alignment.
 - α Horizontal angle
 - β Vertical angle

Drilling rig orientation step-by-step with Drilling rig orientation: Drill Pattern

1. Make sure that **Stake tunnel** and **Stake: Stake face** is selected.
2. In **Tunnel Settings, Tunnel design** page, set **Drilling rig orientation: Drill Pattern**. Refer to "Road Settings,Tunnel design page".
3. In the **Define** panel, check **Drilling rig orientation** and select the app of the drill pattern. Refer to "Defining the Work".
4. If **Apply drill pattern from: Defined Chainage** was selected, then proceed to define the drill entry position for the measured chainage by entering the defined chainage centreline offsets in the **Stake Face**,  page and the drill angles according to the defined chainage.
5. In the **Stake Face**,  page, enter the defined chainage value in the **Stake chainage** editable field. To position the laser pointer correctly on the measured tunnel face press **Fn Position**.
 -  The delta chainage value after using **Fn Position** is the difference between the defined and measured chainage. It is normal if the delta is large. The delta position and delta height values after this step should equal zero.

- Position the drill bit to the laser point on the tunnel face.

Example:

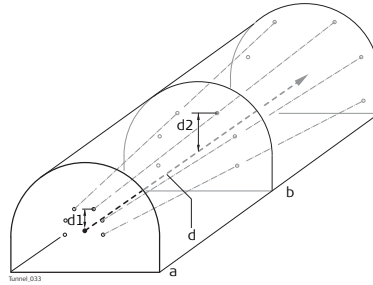

- a Chainage 10
- b Chainage 15
- c Chainage 20
- d Centreline
- d1 **Height offset** at defined chainage 10
- d2 **Height offset** at defined chainage 15



Stake face point 1 at chainage 10 (point1). Stake face point 1 at chainage 15 as defined at chainage 10. Position and direction at chainage 15 are a result of the **Offset**, **Height offset** and drilling angles as defined for chainage 10.

- Now the jumbo boom moves onto line between the laser point on wall and the telescope so that the laser now points at the back of the boom. Press **Fn Tools**. Select **Check Jumbo position** to get the delta values which are used by the drilling rig to move the boom for the correct drilling direction.

47.3.3

Stake profile and Check profile

Stake/Check point on surface

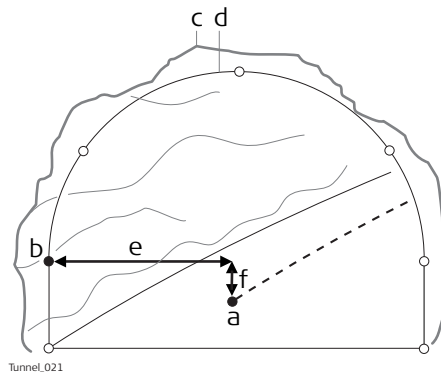

- a Centreline
- b Design point to stake out
- c Excavated profile
- d Design profile
- e Centreline offset
- f Centreline height difference

If it is not possible to stake out the defined point between successive iterations, the instrument will maintain the chainage and height difference from the vertical alignment fixed. The horizontal offset from the centreline to calculate the new position of the point are modified. The point that will be staked out will thus maintain the defined chainage and height difference but will have a modified offset value from the centreline.

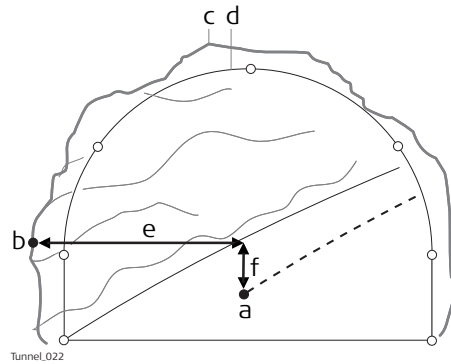

- a Centreline
- b Point to stake out on excavated profile
- c Excavated profile
- d Design profile
- e Centreline offset
- f Centreline height difference

Rotated profile

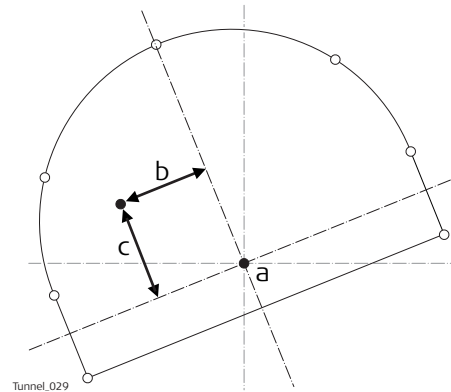

- a Centreline
- b Rotated centreline offset
- c Rotated centre height difference

47.3.4

Scan profile

Overview

A tunnel surface is scanned in detail during construction and/or at the completion of construction to detect overbreak, underbreak and/or to create an 'as built plan' of the finished tunnel surface.

Scan profile allows measuring a user-defined number of tunnel profiles along an existing tunnel alignment.

It can be defined:

- Whether to scan the whole tunnel profile or just a segment of it.
- The interval between measurements around the profile.

It does not matter if a design profile exists in the job or not.



If the job does not contain a design profile, then before scanning the defined scan area the instrument will first scan a profile at the instrument chainage.



For a description of the **Scan Profile, Scan area** page, refer to "47.3.1 Overview".

During a scan

During a scan

- **Next point:** To skip the point being measured and move onto the next profile point.
- **Profile +:** To stop scanning the current profile and move onto the next profile.
- **Temp:** To enter a temporary scan interval.

Pause and options before continuing

It is possible to end the scan once started using **Stop**. To pause the scan, for example to allow passing site traffic through, use **Pause**.

Once the scan has been paused, several options are available before continuing:

- **Stop:** To end the scan.
- **Resume:** To continue the scan at the next position.
- **Manual:** To interrupt the current scan so aiming can be done manually and points added.
- **Auto:** After measuring points manually, press **Auto** to continue scanning where you finished before pressing **Manual**.

Define Temp Scan Interval

By pausing the current scan and pressing **Fn Temp**, a temporary scan interval can be entered. All scan segments being scanned at the defined temporary scan interval until the **Define Temp Scan Interval** panel is reentered and **Use a temporary scan interval** is unchecked.

Description of fields

Field	Option	Description
Use a temporary scan interval	Check box	If this box is checked, then scanning stops and any defined scan interval is ignored and replaced by the temporary scan interval.
Temporary scan interval	Editable field	How often a point is measured around a profile.

Invalid measurements

This process is repeated until the measured point is within the chainage limit or the maximum number of iterations has been reached.

Invalid measurement situations could occur, for example:

- in irregular tunnel surfaces, where the horizontal alignment is formed by a curve with a small radius.
- if the end distance or start distance defined in **Scan Profile, Scan area** page were too large.

Scan Segments

If **Define a scan task: Scan segment** was selected in the **Define** panel, then the **Scan Segments** panel allows creating, editing or deleting scan segments.



Key	Description
OK	To continue to Scan Profile after defining the scan segments.
New	To create a scan segment.
Edit	To edit a defined scan segment.
Delete	To delete a defined scan segment.
Scan	To set the metadata for Scan to Yes or No for the highlighted segment.

Description of metadata

Metadata	Description
-	Name of the scan segment.
Scan	Status to scan or not scan a segment.
Interval	How often a point is measured around the profile.

Next step

New to access **New Scan Segment**.

New Scan Segment

This panel allows the definition of one or multiple segments of the scan profile as opposed to scanning the whole profile.

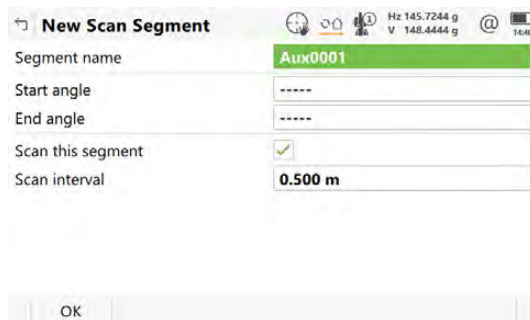

When defining the scan segment, define the start and end angles in the station profile. The vertical circle values are used not the horizontal circle values so transit the telescope between face 1 and 2 as needed.

Key	Description
OK	To store the defined scan segment and return to Scan Segments .
Distance	To measure the distance to points at the starting angle and the end angle of a segment. When Start angle or End angle is highlighted, set the verticle circle values by aiming the telescope at the relevant point and press Distance .
Position	To review the position of the segment once it has been defined. The instrument turns to the corresponding angle. Available when Start angle or End angle is highlighted.

Description of fields

Field	Option	Description
Segment name	Editable field	The name of the scan segment.
Start angle	Display only	The angle measured to the point at the beginning of the segment. Highlight this field, aim at the start of the segment and press Distance to see the angle value in this field.
End angle	Display only	The angle measured to the point at the end of the segment. Highlight this field, aim at the end of the segment and press Distance to see the angle value in this field.
Scan this segment	Check box	When this box is checked, the segment is scanned. When this box is not checked, the segment is not scanned.
Scan interval	Editable field	Defines how often a point is measured in this segment of the profile.

 If overlapping segments are defined, then a non-scan segment has priority over a scan segment.

47.4

The Toolbox

47.4.1

Profile Viewer

Availability

This menu function is available for the check method **Scan profile**.

This menu option is always available. The data that can be viewed depends on those data available in the job. It is independent of the currently measured **Scan Profile** points.



The measured profiles to be viewed must be saved in the job.

Access

1. Press **Fn Tools** in **Stake Face**.
2. Select **Profile Viewer** in **Stake Face Tools**.

View at - Layer Name

Profile	Time	Date	No. points
1.437	07:04:13	25.02.2010	27
1.937	06:46:29	25.02.2010	26
2.437	06:43:42	25.02.2010	27
2.737	07:08:19	25.02.2010	28
3.037	07:11:40	25.02.2010	27
3.337	07:16:56	25.02.2010	28

Key	Description
OK	To confirm the settings and return to the Scan Profile panel.
Delete	To delete the highlighted profile.
More	To display information about the time and the date of when the profile was stored.
Page	To change to another page on this panel.

Description of metadata

Metadata	Description
-	The chainage of the profile.
No. points	The number of points in the profile.
Time and Date	The time and the date of when the profile was stored.

View at - Layer Name, 3D viewer page

Tap on the relevant point for selection. The information displayed shows the centreline offset, the delta height and delta profile of the point.

Measurement	Value
Diff to prof	0.7327 m
CL offset	-0.6301 m
CL ht diff	-0.8673 m
Height	417.7933 m

Key	Description
OK	To accept the settings and return to the Scan Profile panel.
Ch - or Ch +	To decrease/increase the chainage.
Page	To change to another page on this panel.
Fn Settings	To access 3D viewer settings. Refer to "35.3 Configuring 3D viewer".
Fn Position	To position the TS to the defined point, including defined offsets.

Description

To stakeout tunnel face points automatically. The surveyor configures and selects the points to use in the stakeout. The person driving the drilling machine can see the stakeout points looking to the current position of the laser.

Availability

This menu function is available for the stake method **Stake face**.
This menu option is available if the defined chainage has a valid value.
Measure distance: Continuously is supported.

Access

1. Press **Fn Tools** in **Stake Face**.
2. Select **Stake Face Auto** in **Stake Face Tools**.

Stake Face Auto, General page

Key	Description
OK	To access the Stake Face Auto panel.
Page	To change to another page on this panel.

Description of fields

Field	Option	Description
Store staked points	Check box	When this box is checked, the staked points are stored.
Wait time after staked point	Check box	When this box is checked, a time delay is active after staking a point and before staking the next point starts.
Delay	Editable field	The time delay after staking a point and before staking the next point starts. Available when Wait time after staked point is checked.
Verify orientation	Check box	When this box is checked, the system checks orientation automatically in a defined interval. If the orientation error is greater than the defined H_z tolerance , then the auto mode is stopped.
Orientation job	Selectable list	A point for the orientation check can be selected from a job on a data storage device. Available when Verify orientation is checked.
Orientation point	Selectable list	The point ID of the point for the orientation check. Available when Verify orientation is checked.
H_z tolerance	Editable field	Tolerance for horizontal directions. If the orientation error is greater than the defined angle, then the auto mode is stopped. Available when Verify orientation is checked.

Next step

Page changes to the **Points** page.

Stake Face Auto, Points page

Select the points to include in the stakeout.

Key	Description
OK	To access the Stake Face Auto panel.
Use	To set Yes or No in the metadata for excluding/including the highlighted point.
Page	To change to another page on this panel.

Description of metadata

Metadata	Description
-	Displays the name of all points in the selected Tunnel job .
Use	For Yes : The selected point is used for stake. For No : The selected point is not used for stake.
CL offset	The horizontal offset of the point from the layer centreline.
CL height diff	The height difference of the point to the layer centreline.

Next step

3D viewer shows a cross section, profile and planar view of the design data at the selected chainage.

IF	THEN
a single point is to be selected/deselected	tap on the point.
multiple points are to be selected	click the  icon, drag the stylus in a diagonal line to make a rectangular area.

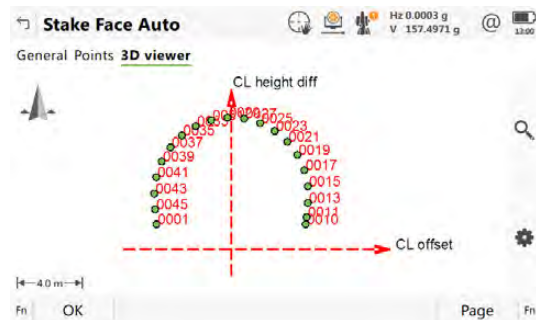

Stake Face Auto

When **Stake face auto** is activated, the measurement panel opens. In a loop, all selected points are automatically staked indefinitely until the measurement is stopped, or the orientation check is out of tolerance.

Key	Description
Stop	To stop the automatic stakeout.
Pause	To pause the automatic stakeout.

Key	Description
Resume	To restart the automatic stakeout.
Back	To select the previous point.
Forward	To select the next point.
Page	To change to another page on this panel.
Fn Settings	To access settings. Refer to "43.3 Configuring Roads Apps".
Fn Display	To configure what is displayed in 3D viewer.

47.4.3

Export DXF Profiles

Description

To export the measured profiles against the selected tunnel section in a DXF file.

Example of a result:

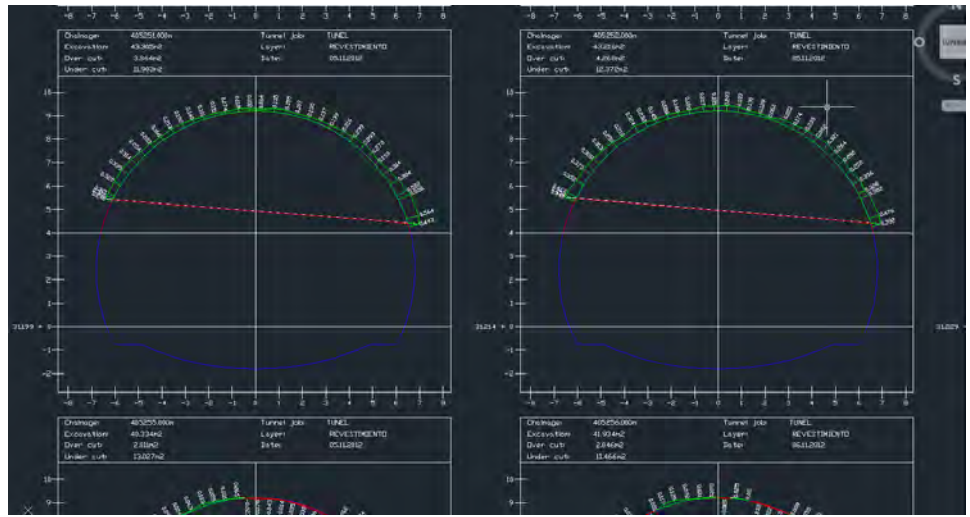

Availability

This menu function is available for the check method **Scan profile**.

Access

1. Press **Fn Tools** in **Scan Profile**.
2. Select **Export Dxf Profiles** in **Scan Profile Toolbox**.

Export Dxf Profiles

Key	Description
OK	To accept the settings.
Fn Settings	To define what is exported.

Description of fields

Field	Option	Description
To folder	Selectable list	Defines if the data is exported to the \DATA directory or to the folder where the selected job is located.
To device	Selectable list	Available for To folder: Data . Defines which data storage device the data is exported to.

Field	Option	Description
	Display only	Available for To folder: Same as job . Displays the data storage device of the selected Job .
Working job	Display only	Data is stored to this job.
Tunnel job	Display only	Contains all the information about the tunnel design including the geometry of the centre-line and the tunnel profile. The files are stored in the \DBX folder or a subfolder of \DBX. The tunnel job is a read-only source of information.
Layer	Display only	The layer from the active tunnel job, selected in the Define panel.
Start chain-age and End chain-age	Editable field	Define the range from which DXF profiles are exported.
Report sheet	Editable field	The name of the file to which the data is exported.

Next step

Fn Settings goes to **Dxf Export Settings**.

Dxf Export Settings

Key	Description
OK	To save the settings and return to Export Dxf Profiles .

Description of fields

Field	Option	Description
Columns	Editable field	The number of columns to organise the DXF. Example: With 4 selected, four profiles are exported per line.
Export excavation areas	Check box	When this box is checked, the excavation areas of the tunnel are exported.
Close the measured profiles	Check box	When this box is checked, the exported profiles are closed for display purposes.
Use a comparison plane	Check box	When this box is checked, a plane is added to the export file for comparison purposes. The plane is added in the defined difference from the centreline.
CL height diff	Editable field	Height difference from the centreline.
Use a profile offset filter	Check box	When this box is checked, only the profiles for which the perpendicular offset to the design profile is smaller than the defined limit are exported.

Field	Option	Description
Offset limit	Editable field	Maximum horizontal offset from defined profile.

48

Scanning

48.1

Accessing Scanning

Availability

Available for MS60 R2000 and on CS when connected to MS60 R2000.

Access

Select **Leica Captivate - Home: Scanning**.

Scanning

Depending on the status of the job and the instrument setup, the icons are active or not. If a new job and a new setup have been created, then only **Create scan definition** and **Scan settings** are active.

48.2

Defining a Scan

Access

Select **Create scan definition** in **Scanning**.

The wizard starts.

Create Scan Definition

A unique name for the new scan definition. The name can be up to 16 characters long and include spaces. Input required.

Next changes to the next panel.

Choose Scanning Method

Description of fields

Field	Option	Description
Method		Select one of the following options to define a scan area.
	Rectangular area	Area defined by upper left and lower right corner. Either turn the telescope manually. Or use the Turn to point option from the context menu. Refer to "35.6 Context Menu". If the first point is the top left corner, then the second point is then to the bottom right corner point. Or the first corner is the bottom left corner point and the second point is then the top right corner point.
	Polygonal area	Area defined by three or more corners in clockwise direction. Either point the telescope to the corners (current position of the crosshair). Or draw the polygonal scan area on the Camera page.  The closing line between the first and the last point has a different line style.
Manually entered		To define a scan area manually by typing in the HZ and V value of two diagonal corners of a rectangle.

Field	Option	Description
		 <p>If scan definitions have already been defined from the current instrument setup, the scan areas are displayed on the Camera page in Manually Entered Extents. A new scan area can be defined in addition to the existing scan areas.</p>
	Full dome scan area	The scan area is the full field of view of the instrument.

Next step

Next changes to the next panel.

Camera view

The scan area can be defined on the camera view of the telescope camera and overview camera. Switching between both cameras is possible.











Description of keys









Key	Description
Next	<p>Available when defining rectangular areas. To accept the selected point and to continue with the subsequent panel within the wizard.</p> <p>Available when defining a scan area manually. To accept the defined extension of the scan area and to continue with the subsequent panel within the wizard.</p>
Add	Available when defining polygonal areas. To add the current crosshair position as a next point to the polygonal area.
Distance	To correct the parallax by taking a distance measurement to any surface. The crosshair style changes from the coarse style to the fine style.
Done	Available when defining polygonal areas. To confirm the defined scan area and to proceed to the subsequent panel. At least three points must be defined.
Back	To return to the previous panel where the definition mode can be selected.
Fn Display	To configure the camera view. Refer to "Configuring Scanning".









Description of icons

Icons are available in a toolbar on the right side of the panel.

Icon	Hardware keys	Description
		<p>Camera view</p> <p>To switch to the telescope camera. The style of the crosshairs changes with the camera in use.</p>

Icon	Hardware keys	Description
		Camera view To switch to the overview camera. The style of the crosshairs changes with the camera in use.
	NAVIGATE	For plan and orbital view, the viewing volume is stored with the job. When another app is opened, the same viewing volume is used.
	1	Zoom extents To fit all displayable data, according to filters and the 3D viewer settings, into the panel area, using the largest possible scale.
		Centre to point To centre the 3D viewer on the selected point. If multiple points are selected, the last selected point using a tap is used.
		Single autofocus To activate a single autofocus. Single autofocus deactivates continuous autofocus. Same functionality as pressing the autofocus button on the side cover of the instrument.  While continuous autofocus is active, any manually measured distance updates the focus position.
		Continuous focus on To switch on continuous autofocus.
	2	Zoom + To zoom into the image.
	3	Zoom - To zoom out of the image.
	SET	
		CAD layers To turn layers of background maps (CAD files) on and off. Refer to "6.2 Creating a New Job" for information on CAD files.

Icon	Hardware keys	Description
		<p>Settings</p> <p>To define the display settings. Change the cross-hair colour, what is displayed in the 3D viewer, separately to the plan or orbital views.</p>
		<p>Data range</p> <p>To define a range from the eye point by a minimum and maximum distance. Only data within the range is displayed.</p> <p>Top slider</p> <p>The maximum distance from the eyepoint, for example set to 400.</p> <p>Bottom slider</p> <p>The minimum distance from the eyepoint, for example set to 10.</p> <p>Result</p> <p>Points between 10 m and 400 m from the eyepoint are displayed on the image.</p> <p> To move the slider, tap on the slider, hold and drag it.</p>
CAMERA		
		<p>Capture image</p> <p>To take an image with the active camera.</p>
BRIGHTNESS		
		
		<p>Auto Bright</p> <p>To turn on automatic brightness.</p>
		<p>Bright +</p> <p>To increase the brightness from the current value.</p>
		<p>Bright -</p> <p>To decrease the brightness from the current value.</p>
SKETCH		
		

Icon	Hardware keys	Description
		Erase To remove sketched lines by moving the stylus over the area.
		On/off To activate sketching.
		Line colour To change the line colour. Tap the icon to open a window displaying line colours for selection. Move the stylus over the window to display more colours. The selected line colour is remembered.
		Line weight To change the line width. Tap the icon to open a window displaying line widths for selection. The selected line width is remembered.
		Text mode on/off To type text into the image. Use the keys on the keypad. Tap the screen to specify the insertion point of the text.
SCAN		
		Draw scan area on/off To add a point to the polygonal area tap the point on the display. Moving by cursor keys is active in the drawing mode.
		Remove last point To delete the last selected point of the polygonal area.
		Remove all points To delete the whole boundary of the polygonal area and to restart the definition of the polygonal scan area.

Scan Resolution

The resolution has a direct influence on the file size.

Key	Description
Next	To accept changes and to continue with the subsequent panel within the wizard.
Distance	Available when Define spacing by: Distances is selected. To take a distance measurement to any surface. The measured value is displayed in the Slope distance .

Key	Description
Back	To return to the previous panel.

Description of fields

Field	Option	Description
Define spacing by	Angles	Horizontal and vertical angle values define the scan resolution.
	Distances	Horizontal and vertical spacings at a certain range define the scan resolution.
Hz and V	Editable field	Available for Define spacing by: Angles . The horizontal and vertical angle values defining the scan resolution.
Slope distance	Editable field	Available for Define spacing by: Distances . The range for which the horizontal and vertical spacings are valid.
Horizontal spacing and Vertical spacing	Editable field	Available for Define spacing by: Distances . The horizontal and vertical spacing defining the scan resolution at the defined range.
Estimated points	Display only	The estimated number of points to be scanned according to the defined scan resolution.

Next step

Next changes to the next panel.

Scan Mode

Key	Description
Next	To accept and record the scan mode.
Distance	To measure and display distances.
Back	To return to the previous panel.

Description of fields

Field	Option	Description
Select the appropriate scan speed & range.	1000 pts/s, up to 300m	<ul style="list-style-type: none"> • 1000 Hz scanning mode. • Range up to 300 m. • Optimal to use when time is critical.
	250 pts/s, up to 400m	<ul style="list-style-type: none"> • 250 Hz scanning mode. • Range up to 400 m. • Optimal for use when time and accuracy are critical.
	62 pts/s, up to 500m	<ul style="list-style-type: none"> • 62 Hz scanning mode. • Range up to 500 m. • Optimal for use when accuracy and range are critical.
	Approx 1 pt/s, up to 1000m	<ul style="list-style-type: none"> • 1 Hz long range mode. • Range up to 1000 m. • Optimal for long range applications

Field	Option	Description
Time required	Display only	The time that the measurement needed.
Average scan distance (optional)	Editable field	Slope distance to the scanning object. This distance is optional. By knowing the distance to the object, the system optimises the scanning speed.

Next step

Next changes to the next panel.

Scan Distance Filter

Key	Description
Finish	To exit the wizard.
Back	To return to the previous panel.

Description of fields

Field	Option	Description
Only scan objects within a distance range	Check box	When this box is checked, only objects within the defined distance range are scanned.
Minimum distance	Editable field	Minimum distance of the scan distance.
When distance changed by	Editable field	Maximum distance of the scan distance.

Next step

Finish to exit the wizard.

48.3

Configuring Scanning

Access

Select **Scan settings** in **Scanning**.

Scan Settings

Key	Description
OK	To return to Scanning .

Description of fields

Field	Option	Description
Store signal to noise ratio (SNR) values with scan points	Check box	When this box is checked, the value of the Signal to Noise Ratio of the returned signal is stored as additional information to the scan area.

Field	Option	Description
Store scan area on panoramic image (if pano image is captured)	Check box	When this box is checked, the scan area is laid over the image and stored with the image when a panoramic image is captured.
Pause scanning when a message is shown	Check box	When this box is checked, a scan is paused when a message is shown.
Apply filter to minimise mixed pixels	Check box	When this box is checked, an algorithm to reduce mixed pixels is applied to the scan.
Apply filter to optimise the point cloud	Check box	When this box is checked, the filter creates an optimum of the point cloud regarding data quality.

48.4

Starting a Scan

Access

Select **Start scan** in **Scanning**.

Scan Status, Progress page

Key	Description
Start	To start scanning.
Stop	To end scanning. The already scanned points are stored in a file. The scan gets the status Scan completed .
Pause and Scan	To pause/re-start scanning.
Display	Available as long as the scan has not yet started. To take an image with the current pixel resolution.
Page	To change to another page on this panel.

Description of fields

Field	Option	Description
Scan name	Display only	Then name of the first or current scan.
Points scanned	Display only	The total number of scanned points.
% completed	Display only	In percent, the number of scans taken against the total number of scans which must be taken.
Time remaining	Display only	Estimated time remaining until the scan is finished.

Field	Option	Description
Scans completed	Display only	Number of scans being measured / Number of total scans

Description

Sets of Angles:

- This app is used to measure multiple sets of directions and distances (optional) to pre-defined target points in one or two faces.
- The mean direction and mean distance (optional) to each target point, within a set is calculated. The residual for each direction and distance (optional) within a set is also calculated.
- The reduced average direction and average distance (optional) to each target point, for all active sets is calculated.
- Coordinates to each target point are calculated using the reduced average direction and average distance (optional).

Monitoring:

- This module is integrated within the Sets of Angles program.
- With this module, it is possible to use a timer to enable repeated and automated angle and distances measurements to pre-defined target points at defined intervals.

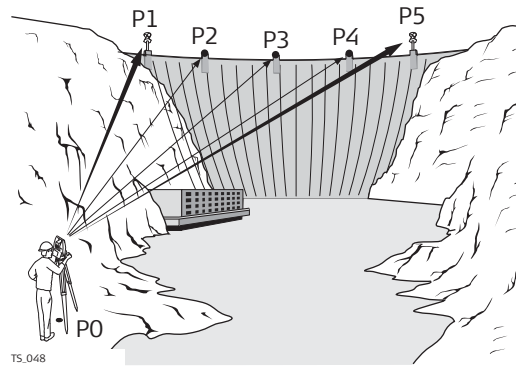

If the message panel appears which requires that the app must be activated using a licence key then refer to "29.3 Load licence keys".

Diagram**Known:**

- P1 Pre-defined target point - E,N,Height (optional)
- P2 Pre-defined target point - E,N,Height (optional)
- P3 Pre-defined target point - E,N,Height (optional)
- P4 Pre-defined target point - E,N,Height (optional)
- P5 Pre-defined target point - E,N,Height (optional)

Unknown:

- a Mean direction and mean distance (optional) to each target point, within a set
- b Mean coordinates (optional) for each target point, for all active sets
- c Residual for each direction and distance (optional), within a set
- d Reduced average direction and average distance (optional) to each target point, for all active sets

Automatic aiming	Automatic aiming (search and measurements) can be performed to a prism. After completing the first measurements to each target point, the measurements to the target points in subsequent sets are automated.
Setup and orientation	To record oriented grid coordinates, setup and orientation are required before starting the Measure sets app.
Point averaging	Sets of Angles points are never calculated as an average, even if a measured point of class Measured already exists with the same point ID.

49.2 Sets of Angles

49.2.1 Accessing Sets of Angles

Access Select **Leica Captivate - Home: Measure sets**.

Measure sets of angles

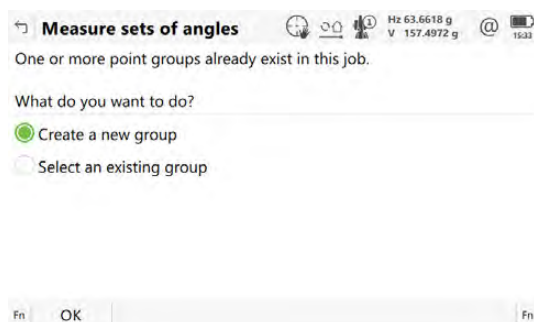

Key	Description
OK	To select the highlighted option and to continue with the next panel.
Fn Settings	To configure the Sets of Angles app. Refer to "49.2.2 Configuring Sets of Angles".

Description of options

Options	Description
Create a new group	To define the target points. Refer to "49.2.3 Creating New Point Groups".
Select an existing group	To select, edit and manage a points group of the target points for the survey. Refer to "49.2.4 Managing Existing Point Groups".

49.2.2 Configuring Sets of Angles

Access Select **Leica Captivate - Home: Measure sets**. Press **Fn Settings**.

Settings, Parameters page

The explanations for the softkeys given here are valid for all pages, unless otherwise stated.

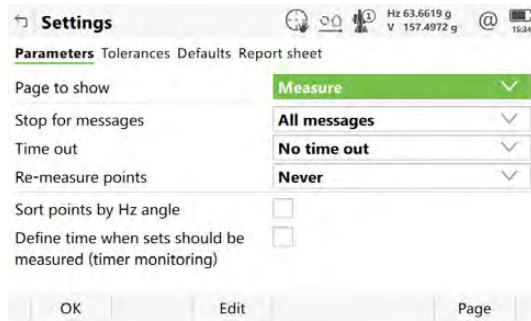

Key	Description
OK	To accept changes and return to the panel from where this panel was accessed.
Edit	To edit the page currently being displayed. Available when a list item in Page to show is highlighted. Refer to "26.2 User defined pages ".
Page	To change to another page on this panel.
Fn About	To display information about the program name, the version number, the date of the version, the copyright and the article number.

Description of fields

Field	Option	Description
Page to show	Selectable list	The names of the available pages.
Stop for messages	All messages	To define what action is taken when a message panel appears during a measurement set. All message panels are displayed as per normal and are closed as defined by the settings in Time out .
	Tol exceeded only	Only the message panel relating to the exceeding of tolerances is displayed and is closed as defined by the settings in Time out .
	Never stop	No message panels are displayed except for specific warnings. Specific warnings which affect the instrument and its ability to continue with the monitoring process is displayed and remains on the panel. These warnings include the overheating of the instrument, low battery levels, or unavailable space on the data storage device.
Time out		To define the time delay for the automatic closing of message panels during a measurement set. This selectable list is not available when Stop for messages:Never stop .

Field	Option	Description
	No time out	There is no automatic closure, only by user interaction in a message panel. When a message panel appears, press Yes to close.
	1sec to 60sec	All message panels are automatically closed as defined by these individual time settings.
Re-measure points		To define the action if a target point cannot be measured.
	Never	The target point is skipped and the next target point in the list is measured.
	Automatically	The measurement to the target point is repeated automatically.  The option for Measure distance in Measure & Target is also changed for the repeated measurement. If the option is changed, then it is applied to all following sets.
	Manually	The measurement to the target point can be repeated manually or the target point can be skipped.
Sort points by Hz angle	Check box	Check this box to sort the target points automatically. The instrument works in a clockwise direction and finds the shortest path to move between the target points.
Define time when sets should be measured (timer monitoring)	Check box	When this box is checked, automatic monitoring of target points is activated.
		When this box is not checked, automatic monitoring of target points is not activated. The Sets of Angles app applies.

Next step

Page changes to the **Tolerances** page.

Settings, Tolerances page

Description of fields

Field	Option	Description
Use tolerances	Check box	If checked, the entered horizontal, vertical and distance tolerances are checked during the measurements to verify accurate pointing and measurements.
Hz tolerance	Editable field	Tolerance for horizontal directions.
V tolerance	Editable field	Tolerance for vertical directions

Field	Option	Description
Distance tolerance	Editable field	Tolerance for distances.

Next step

Page changes to the **Defaults** page.

Settings, Defaults page

Define the default target properties for points that are added to the point group by importing.

Description of fields

Field	Option	Description
Target height	Editable field	The default prism height.
Target	Selectable list	Target names as configured in the Targets panel.
Leica constant	Display only	The additive constant as stored for the selected prism in the Leica Captivate software.
Aim at target	Manually	Measurements are done without any automation. ATRplus search and/or ATRplus measurement are not performed.
	Automatic	Positioning to static prisms. The ATRplus sensor is used for measurements to static prisms. If needed, an ATRplus measurement or ATRplus search is performed after pressing Measure or Distance .
	With lock	The instrument locks onto and follows the moving prism. The ATRplus sensor is used to follow moving prisms and to find prisms after loss of lock. Depending on the setting for Measure distance , single or continuous measurements are performed. Unavailable for SmartStation.
Visibility		Available when a CS20 is connected to a TS15/TS50/TM50/MS50. TS16/TS60/MS60 automatically adjust the settings for optimal performance.
	Good	If weather conditions are normal, then select this mode.
	Rain & fog	To increase the instrument measuring ability during suboptimal weather conditions. This mode is automatically deactivated when the instrument is turned off.

Field	Option	Description
	Sun & reflections	To increase the instrument measuring ability during incident solar radiation and reflections, for example safety vests. This mode has a considerable influence on the range (restriction 100 - 150 m). This mode is automatically deactivated when the instrument is turned off.
Use ultra fine aiming	Check box	Reduces the field of view of the ATRplus. The setting is only applied for Aim at target: Automatic .
Automatically measure points	Check box	Check this box to survey the target points automatically. The instrument turns automatically and measures the target point. For instruments with automatic aiming.

Next step

Page changes to the **Report sheet** page. Refer to "36 Apps - General".

49.2.3

Creating New Point Groups

Description

The points to be used for Sets of Angles can be selected and the first set measured. The measurement settings of the first measurement to each point are used for all further sets.

Access

Highlight **Create a new group** in **Measure sets of angles** and **OK**.

New Point Group

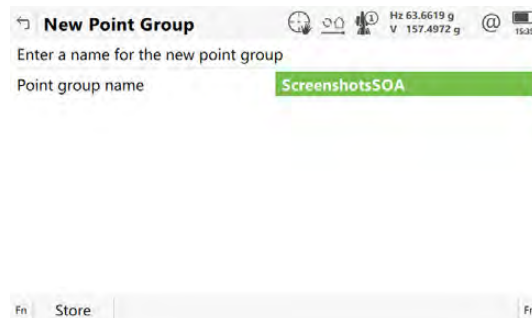

Key	Description
Store	To store the new points group.
Fn Settings	To configure the Sets of Angles app.

Description of fields

Field	Option	Description
Point group name	Editable field	The name of the points group.

Add Points To Group

Key	Description
OK	To select the checked option and to continue with the next panel.

Description of options

Option	Description
Measure points	When this box is checked, the points to be used for Sets of Angles can be measured.
Use within a set of measurements	Available when Measure points is checked. To select the measuring sequence.
Add individual points from a job	When this box is checked, a design job can be selected. Individual points can be selected from this job. Refer to "Select Points - Measure, Sets page".
Add all points from a job	When this box is checked, a design job can be selected. All points from the design job are added to the point group by pressing OK .

Select Points to be Added, Points page



The points are sorted in alphabetical order. To sort points by horizontal angle, check **Sort points by Hz angle** in **SettingsParameters**, page.

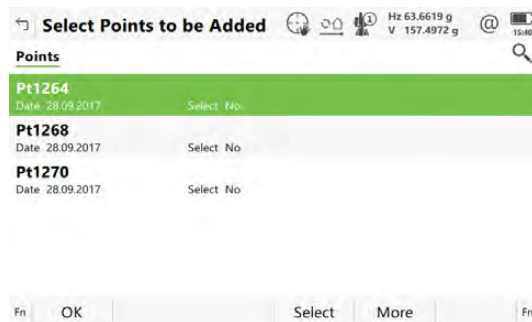

Key	Description
OK	To store the points to the group.
Select	To change the setting for the Select metadata for the highlighted point.
More	To display information about the 3D coordinate quality, the class, Easting, Northing and Elevation, the time and the date of when the point was stored,
Page	To change to another page on this panel.
Fn All or Fn None	To change the setting for the Select metadata for all scans at once.

Next step

In **3D viewer**, the points from the list are displayed in black. The other points from the job are displayed in grey.

Define Points for Set

Define Points for Set

Points measured: 0

Point ID: TS0001

Target height: 1.500 m

Target: Leica round prism

Leica constant: 0.0 mm

Measure distance: Once

Aim at target: Manually

Automatically measure points:

Fn OK Done Fn

Key	Description
OK	To measure the entered point and to access Select Points - Measure .
Done	To finish selection of points and access Measure sets of angles for further steps.
Fn Settings	To configure the Sets of Angles app.
Fn Get Pt	To select points from the design job.

Description of fields

Field	Option	Description
Use precise target aiming	Check box	Available for the 0.5" instruments of TS60. When this box is checked, four ATRplus measurements are performed and the mean value out the measurements is considered for the angle value.
Use ultra fine aiming	Check box	Reduces the field of view of the ATRplus. The setting is only applied for Aim at target: Automatic in Measure & Target .
Automatically measure points	Check box	Available for instruments with automatic aiming and Aim at target:Automatic . If checked, search and measurements are done to specified targets in sets.

Next step

IF	THEN
new or selected points are to be measured	OK to access Select Points - Measure .
existing points are to be selected	Fn Get Pt to select a point from the design job.
all desired points have been selected and measured	Done to return to the previous panel.

Select Points - Measure, Sets page

Key	Description
Measure	To measure and store the angles and distance, and to return to Define Points for Set .
Distance	To measure a distance.
Store	To store data and to return to Define Points for Set .
Page	To change to another page on this panel.

Description of fields

Field	Option	Description
Difference in Hz	Display only	Difference between the current horizontal angle and the horizontal angle to this target when selected.
AR diff	Display only	Available when Hz angle display: Angle right is configured in Regional, Angle page. Difference between the current angle right and the angle right to this target when selected.
Difference in V	Display only	Difference between the current vertical angle and the vertical angle to this target when selected.
Difference in slope dist	Display only	Difference between the current slope distance to the target and the slope distance to this target when selected.

49.2.4

Managing Existing Point Groups

Description

A point group of the target points for the survey can be selected.

Access

Highlight **Select an existing group** in **Measure sets of angles** and **OK**.

Existing Point Groups

Key	Description
OK	To continue with the next panel.
Fn Settings	To configure the Sets of Angles app. Refer to "49.2.2 Configuring Sets of Angles".

Description of fields

Field	Option	Description
Point Groups	Selectable list	The name of the points group.
Number of points	Display only	The number of points in the group.
Creation date	Display only	The date of when the point group was created.
Creation time	Display only	The time of when the point group was created.

Next step



OK to access **Point Groups**.

Point Groups



Key	Description
OK	To continue with the next panel.
New	To create a point group.
Edit..	To edit the highlighted point group.
Delete	To delete an existing points group.

Edit Point Group, Points page

Key	Description
Store	To store the points to the group.
Add points	To add points to the group.
Edit	To view or change the settings for a point.
	Previous to display the previous point of the point group. Available unless the beginning of the list is reached.
	Next to display the next point in the list of points. Available unless the end of the list is reached.
More	To display information about the date, the 3D coordinate quality, the point code, the target height and fine aiming.
Page	To change to another page on this panel.
Fn Remove 1	To remove all points from the group.

Key	Description
Fn Remove all	To remove the highlighted point from the group. The point itself is not deleted.

49.2.5

Measuring the Sets

Description

The points defined in the point group are measured with the defined measurement method and for the defined number of sets.

Access

Highlight **Measure Sets** in **Measure sets of angles** and **OK**.

Measure Sets

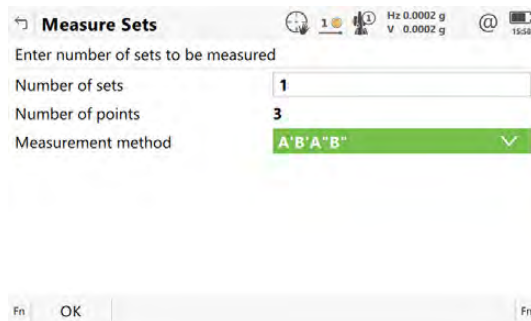

Key	Description
OK	Opens a panel to measure the points. When auto survey is activated, measurements are done automatically.
Fn Settings	To configure the Sets of Angles app. Refer to "49.2.2 Configuring Sets of Angles".

Description of fields

Field	Option	Description
Number of sets	Editable field	The number of sets to measure with the target points. The maximum of sets allowed is 200.
Number of points	Display only	The number of target points.
Measurement method		Determines the order in which the target points are measured.
	A'A''B''B'	The target points are measured in face I and face II. point A I - point A II - point B II - point B I ...
	A'A''B''B''	The target points are measured in face I and face II. point A I - point A II - point B I - point B II ...
	A'B'A''B''	The target points are measured in face I and face II. point A I - point B I... point A II - point B II ...

Field	Option	Description
	A'B'B"A"	The target points are measured in face I and face II. point A I - point B I... point B II - point A II...
	A'B'C'D'	The target points are only measured in face I. point A I - point B I - point C I - point D I ...

Next step

OK to measure further sets of the defined points.

Set n of n, Pt n of n, Sets page

Sets	
Point ID	1010
Target height	0.000 m
Hz	262.6291 g
V	100.9850 g
Slope distance	-----
Difference in Hz	-----
Difference in V	-----

Key	Description
Measure	To measure and store the angles and distances, and to increment to the next point.
Distance	To measure a distance.
Store	To store data and to increment to the next point.
Skip	To skip measuring the displayed point and continue with the next point.
Pause or Resume	To pause/re-start the set measurement.
Page	To change to another page on this panel.
FnDone	To end the measurements and to return to Measure sets of angles .

Description of fields

Field	Option	Description
Difference in Hz	Display only	Difference between the current horizontal angle and the horizontal angle to this target when selected.
Difference in V	Display only	Difference between the current vertical angle and the vertical angle to this target when selected.
Difference in slope dist	Display only	Difference between the current slope distance to the target and the slope distance to this target when selected.
Aim at target	Manually	Measurements are done without any automation. ATRplus search and/or ATRplus measurement are not performed.

Field	Option	Description
	Automatic	Positioning to static prisms. The ATRplus sensor is used for measurements to static prisms. If needed, an ATRplus measurement or ATRplus search is performed after pressing Measure or Distance .
	With lock	The instrument locks onto and follows the moving prism. The ATRplus sensor is used to follow moving prisms and to find prisms after loss of lock. Depending on the setting for Measure distance , single or continuous measurements are performed. Unavailable for SmartStation.
Visibility		Available when a CS20 is connected to a TS15/TS50/TM50/MS50. TS16/TS60/MS60 automatically adjust the settings for optimal performance.
	Good	If weather conditions are normal, then select this setting.
	Rain & fog	To increase the instrument measuring ability during suboptimal weather conditions. This setting is automatically deactivated when the instrument is turned off.
	Sun & reflections	To increase the instrument measuring ability during incident solar radiation and reflections, for example safety vests. This setting has a considerable influence on the range (restriction 100 - 150 m). This setting is automatically deactivated when the instrument is turned off.
Use precise target aiming	Check box	Available for instruments other than TS60/TM50/TS50/TS30/TS60. When this box is checked, four ATRplus measurements are performed and the mean value out the measurements is considered for the angle value.
Use ultra fine aiming	Check box	Reduces the field of view of the ATRplus. The setting is only applied for Aim at target: Automatic .
Automatically measure points	Check box	Available for instruments with automatic aiming and Aim at target: Automatic . If checked, search and measurements are done to specified targets in sets.

Next step

Measure to measure further sets of the selected points.



- Motorised instruments point automatically in the direction of the targets.
- Instruments with automatic aiming and auto survey activated, measure the targets automatically.

Measurement Summary

This panel is displayed automatically at the end of the sets measurement.

Key	Description
OK	To continue with the next panel.

Description of metadata

Metadata	Description
-	Points of the point group in the same order as in the point group.
Compl meas	How many times the point was successfully measured. Example: 4/6 - The point was measured four times, six sets were measured.
In tolerance	How many times the tolerance configured was met. Example: 4/6 - The point falls within the defined tolerance four times, six sets were measured.
Compl sets	How many sets are completed. The value is the same for all points. Example: 4/6 - The point was measured in a complete set four times, six sets were measured.

After measuring sets

Depending on points skipped or not, select how to continue.

Key	Description
OK	To select the highlighted option and to continue with the next panel.

Description of options

Options	Description
Always available:	
Measure more sets	To measure extra sets.
Available for sets incomplete:	
Re-measure incomplete sets	To remeasure the skipped points in the face that was skipped. To fill in the missing measurements in the sets.
Remove incomplete points	To calculate results. The skipped points are discarded. Only points measured in all sets are used for the calculation.
Remove incomplete sets	To calculate results. The sets that contain skipped points are discarded. Only the complete sets are used for the calculation.
Available for sets complete:	
View & manage results	Available when no points are skipped. Refer to "49.2.6 Managing Results".
Compute points from results	Available when no points are skipped. To compute points from set results.

Options	Description
Exit app	To end the Sets of Angles program.

49.2.6

Managing Results

Description

For two and more sets measured with angles and distances in two faces, calculations for angles and distances can be done.

For sets measured in one face, the standard deviation and average values can be viewed.

If only one set or point is measured, only some of the values are displayed.

Manage Results

If points are measured with method **A'B'C'D'**, the points results are limited and only standard deviation and average values are shown.

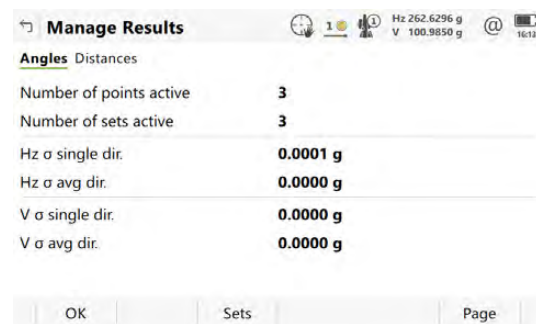

Key	Description
OK	To return to the previous panel.
Sets	To view angle/distance results.
Use	To activate/deactivate sets.
Page	To change to another page on this panel.

Description of fields

Field	Option	Description
Number of points active	Display only	Number of active points which are set to Yes for the Select metadata in the Select Points to be Added panel.
Number of sets active	Display only	Number of active sets which are set to Yes for the Select metadata in the Angle Results/Distance Results panel.
Hz σ single dir.	Display only	Standard deviation of the single horizontal direction.
Hz σ avg dir.	Display only	Standard deviation of the average horizontal direction.
V σ single dir.	Display only	Standard deviation of a single vertical direction.
V σ avg dir.	Display only	Standard deviation of the average vertical direction.

Field	Option	Description
Standard deviation (σ) single distance	Display only	Standard deviation of a single distance.
Std deviation (σ) of avg distance	Display only	Standard deviation of the average distance.

Next step

Sets accesses the **Angle Results/Distance Results** panel.

Angle Results/ Distance Results

Angle Results		
1	Hz Σr Residl: 0.0002 g	V Σr Residl: 0.0000 g
2	Hz Σr Residl: -0.0003 g	V Σr Residl: 0.0000 g
3	Hz Σr Residl: 0.0001 g	V Σr Residl: -0.0000 g

Use: Yes

Use: Yes

Use: Yes

Fn OK Points Use Fn

Key	Description
OK	To return to the previous panel.
Points	To access Residuals in Set n .
Use	To set Yes or No in the Use metadata for the highlighted set.

Description of metadata

Metadata	Description
-	Displays the number of the sets.
Hz Σr Residl	Shows the calculated absolute sum of residuals in Hz of the selected set. The sum of residuals is the sum of the difference between the reduced average direction and each sets directions. For sets not used in the calculation, ----- is shown.
V Σr Residl	Shows the calculated absolute sum of residuals in V of the selected set. The sum of residuals is the sum of the difference between the average vertical angles and each sets vertical angles. For sets not used in the calculation, ----- is shown.
Max Residl SD	Shows the calculated maximum residuals in slope distance of the selected set. The sum of residuals is the sum of the difference between the average distance and each sets distance. For sets not used in the calculation, ----- is shown.
Use	For Yes : The selected set is used for calculations.

Metadata	Description
	For No : The selected set is not used for calculations.

Next step

Points to access **Residuals in Set n**.

Residuals in Set n



Key	Description
OK	To return to the previous panel.
Use	To set Yes or No for the Use metadata for the highlighted point.
More	To view additional information.

Description of metadata

Metadata	Description
-	Point ID of the measured points in the order they were defined and measured.
Hz Residual	Residual in the Hz value of the selected point within the single set.
V Residual	Residual in the V value of the selected point within the single set.
Avg Hz	Reduced Average Hz value of the point in all active sets.
Avg V	Average V value of the point in all active sets.
Mean Hz	Mean Hz value of the point within the single set.
Mean V	Mean V value of the point within the single set.
SD Residual	Residual in the distance value of the point within the single set.
Avg SD	Average distance value of the point in all active sets.
Mean SD	Mean distance value of the point within the single set.
Use	For Yes : The selected point is used for calculations in all sets. For No : The selected point is not used for calculations in any set.

Compute Points,
General page

Key	Description
Store	To store the point with class CTRL in the database. The averaged angles and distances are stored as point results to the point.
Page	To change to another page on this panel.

Description of fields

Field	Option	Description
Number of points active	Display only	The number of selected points having been measured.
Number of sets active	Display only	The number of sets having been measured.
Store point ID with	Prefix	Adds the setting for Prefix / suffix in front of the original point IDs.
	Suffix	Adds the setting for Prefix / suffix at the end of the original point IDs.
Prefix / suffix	Editable field	The identifier with up to four characters is added in front of or at the end of the ID of the calculated points.
Use a point as reference	Check box	When this box is checked, the point selected is considered fixed: known coordinates and therefore Easting diff and Northing diff are made equal to zero. The values shown on the Points page are updated accordingly.

Compute Points,
Points page

Key	Description
Store	To store the calculated points which are set to Yes for the Accept metadata.
Accept	To set Yes or No for the Accept metadata for the highlighted point.

Description of metadata

Metadata	Description
-	Point ID of the measured points in the order they were defined and measured.
Easting diff	The difference in Easting between the original and the calculated points.
Northing diff	The difference in Northing between the original and the calculated points.
Accept	For Yes : The selected point is used for calculations in all sets. For No : The selected point is not used for calculations in any set.

Description

Monitoring is a module integrated within the Sets of Angles app.

Monitoring uses a timer to enable repeated and automated angle and distances measurements to pre-defined target points at defined intervals. The ability to configure the handling of message panels during measurement sets is also enabled.

Important aspects

For monitoring, instruments must be motorised.

Monitoring preparation

This step-by-step description is an example on preparing a set for monitoring.

1. Select the control job and the job.
2. Set setup coordinates and setup orientation.
3. Select **Leica Captivate - Home: Measure sets**.
4. In **Measure sets of angles** press **Fn Settings** to configure Sets of Angles for monitoring.
For the **Parameters** page set:
 - **Stop for messages: All messages** (for example purposes only).
 - **Time out: 10 secs** (for example purposes only).
 - **Define time when sets should be measured (timer monitoring)** Select this option for monitoring. This setting enables access to the **Define Monitoring Timer** panel.
5. Press **OK** to access the **Measure sets of angles** panel.
6. Select **Create a new group**.
7. Press **OK** to access the **Define Points for Set** panel.
8. Enter details of the target point as required.
For each target point, ensure that auto survey is activated. This setting enables the automated measurement and recording of the target point in the other face. The setting also enables the automated measurement and recording of all target points during monitoring.
9. Press **OK** to access the **Select Points - Measure** panel.
10. Measure and record the measurement to the target point as required.
11. Continue with steps 8. to 10. until all target points for the first measurement set have been measured and recorded.
12. Press **Done** to complete the selection of the target points for the first measurement set in one face. This action then begins the measurement of the target points in the other face. On completion, the **Measure sets of angles** panel is accessed.
13. Select **Measure Sets**.
14. Press **OK** to access the **Define Monitoring Timer** panel.

Define Monitoring Timer**Description of fields**

Field	Option	Description
Begin date	Editable field	Start date for monitoring.

Field	Option	Description
Begin time	Editable field	Start time for monitoring.
End date	Editable field	End date for monitoring.
End time	Editable field	End time for monitoring.
Interval	Editable field	The time between the start of each scheduled measurement set.
Measurement method		Determines the order in which the target points are measured.
	A'A''B''B'	The target points are measured in face I and face II. point A I - point A II - point B II - point B I ...
	A'A''B''B''	The target points are measured in face I and face II. point A I - point A II - point B I - point B II ...
	A'B'A''B''	The target points are measured in face I and face II. point A I - point B I... point A II - point B II ...
	A'B''B''A''	The target points are measured in face I and face II. point A I - point B I... point B II - point A II...
	A'B''C''D''	The target points are only measured in face I. point A I - point B I - point C I - point D I ...

Next step

When all required information is entered press **OK** to begin the monitoring process.

A panel displays a notice that monitoring is in progress. If necessary, press **Cancel** to stop the monitoring process and return to **Measure sets of angles**.

Refer to "49.2 Sets of Angles" for information about calculations and the viewing of results.

Monitoring interval

Description

The dates and times entered define the timeframe for when the monitoring will take place.

The time interval defines the time between the start of each measurement set during the monitoring period. The interval time begins at the start of a measurement set and ends at the start of the next measurement set.

Example

Data;

- 3 target points
- Begin Date: 03.11.2010
- End Date: 06.11.2010
- Interval: 30 min
- 4 measure sets
- Begin Time: 14:00:00
- End Time: 14:00:00

Results;

- The time taken to measure 4 sets of 3 target points in both faces is 10 minutes.
 - The measurements will start at 14:00:00 on 03.11.2010.
 - At 14:10:00, the first measurement set is complete.
 - The instrument will wait until 14:30:00 for the next scheduled measurement set.
-

50.1

Overview

Description

The Setup app is only available for use with TS instruments. Setup determines the coordinates and the instrument orientation using TS measurements and/or GS measurements.

Setup with GS using SmartPole

SmartPole allows target points to be determined using GS measurements. The new points are then used as control points for the TS setup.

Setup with GS using SmartStation

SmartStation allows TS setup coordinates (position and height) to be determined from GS measurements.

Setup methods

Setup Method	"Standard" setup type	"On-the-Fly" setup type	Methods for TS	Methods for SmartPole	Methods for SmartStation
Set orientation	✓	-	✓	-	✓
Known backsight	✓	-	✓	✓	✓
Multiple backsights	✓	✓	✓	✓	✓
Transfer height	✓	-	✓	✓	-
Resection	✓	✓	✓	✓	-
Orientate to line	✓	-	✓	-	✓
Orientate to object	✓	-	✓	-	-

- Each setup method requires different input data and a different number of target points.
- All setup methods are described in "50.6 Setup Methods".

Setup types

"Standard" setup

This type of setup is the traditional type. The user must always measure all setup points consecutively to complete the setup. The TS setup coordinates and TS orientation must be set before measuring survey points.

"On-the-Fly" setup

This setup type allows the user to move between setup and survey before completing the setup (working "on the fly"). When leaving, the TPS setup coordinates and orientation do not have to be final, they can be set at anytime during the survey.

This setup can only be used when measuring survey points. When staking out points, the TS setup coordinates and TS orientation must be set first.

Incomplete setups

- For a "Standard" setup, the user must always measure all setup points consecutively to complete the setup. This type of setup is always regarded as a complete setup.
- For "On-the-Fly" setups, the setup points can be measured together with the survey points. It is not necessary to complete the setup before measuring survey points. Until the user selects **Set** in **Setup Results**, this type of setup is regarded as incomplete.

An incomplete setup, or a setup where more targets can be added, can be accessed in the following ways:

1. In the Measure app, Setup can be accessed by selecting the **Setup** softkey.

2. When entering any panel where measurements are possible, a message is displayed to notify that the setup is incomplete. It is then possible to:
 - a) continue with the existing app, or **OK**
 - b) start Setup and create a setup, or **New**
 - c) start Setup and continue to measure more fix-points. **Setup**

3. Assigning the function **TS - Continue open setup** to the favourites or a hot key.

Linked jobs and global data

Linked jobs will overwrite the points and lines from the global design job selected in **Design Data**.

50.2

Accessing Setup

Access

Select **Leica Captivate - Home: Setup**.

Total Station Setup

An illustration and a description is shown for each **Setup method**.

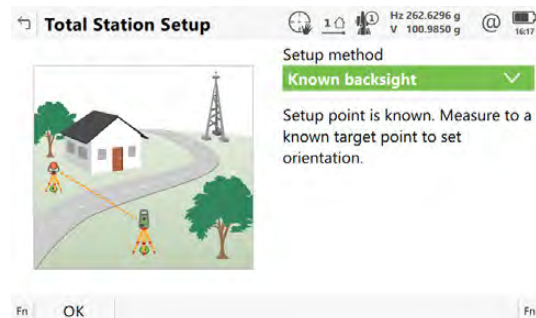

Key	Description
OK	To accept changes and access the subsequent panel. The chosen settings become active.
Fn Settings	To configure the Setup app. Refer to "50.3 Configuring Setup".

50.3

Configuring Setup

Access

Press **Fn Settings** in **Total Station Setup**.

Settings, General page

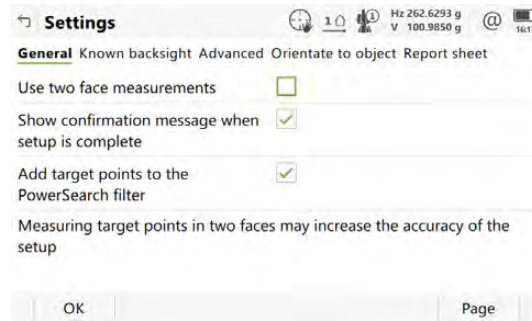

Key	Description
OK	To accept changes and return to the panel from where this panel was accessed.
Page	To change to another page on this panel.
Fn About	To display information about the app name, the version number, the date of the version, the copyright and the article number.

Description of fields

Field	Option	Description
Use two face measurements	Check box	<p>Defines if the instrument measures the second face automatically after storing the first.</p> <p>When this box is checked, after storing a measurement with All or Store motorised instruments change face automatically, non-motorised instruments access Telescope Positioning. The measurements of facel and facell are averaged. The averaged value is stored.</p> <p>When this box is not checked, no automatic measurement in two faces.</p> <p> When using two face measurements, then the angle right value is averaged between both two face measurements.</p>
Show confirmation message when setup is complete	Check box	When this box is checked, a message informs when the setup is finished.

Field	Option	Description
Add target points to the PowerSearch filter	Check box	<p>When this box is checked, the setup points are included in PowerSearch scans looking for available prisms. Refer to "Bubble icons" for more information.</p> <p> By unchecking the box, the likelihood to only find the correct prisms on the robotic pole is increased and the time to find the prisms is significantly decreased.</p>

Next step

Page changes to the **Known backsight** page.

Settings,
Known backsight
page

For **Setup method: Known backsight**, the settings on this page apply.

Description of fields

Field	Option	Description
Check measurement to backsight (2D position)	Check box	Allows a check to be made on the horizontal coordinate difference between the existing and the measured known backsight point. If the defined Position limit is exceeded, the setup can be repeated, skipped or stored.
Position limit	Editable field	Available when Check measurement to backsight (2D position) is checked. Sets the maximum horizontal coordinate difference accepted in the position check.
Check measurement to backsight (1D height)	Check box	Allows a check to be made on the vertical difference between the existing and the measured known backsight point. If the Height limit is exceeded, the setup can be repeated, skipped or stored.
Height limit	Editable field	Available when Check measurement to backsight (1D height) is checked. Sets the maximum vertical difference accepted in the height check.

Next step

Page changes to the **Advanced** page.

For **Setup method: Resection** and **Setup method: Multiple backsights**, the settings on this page apply.

Description of fields

Field	Option	Description
Automatically turn TS to next target point	Check box	When this box is checked, the instrument positions horizontally and vertically to the point.
Measure target points while measuring other points (on-the-fly)	Check box	When this box is checked, the setup points can be measured together with the survey points. It is not necessary to complete the setup before measuring survey points. Until you select Set in Setup Results , this type of setup is regarded as incomplete.
Calculate & show scale from the measurements made to targets	Check box	Only available if Scale TS measurements is unchecked in the job properties TS scale page. If checked, a setup scale is calculated from the target observations. You can apply this new scale (calculated ppm + current ppm = new ppm) to all survey observations, including the setup observations, from that setup. If not checked, then the calculated ppm is not displayed and therefore not applied to any survey observations.
For resections use Helmert method for calculations	Check box	Helmert calculation is used.
Height weighting	1/distance or 1/distance²	Available when For resections use Helmert method for calculations is checked. To change the distance weighting that is used in the calculation of the setup height in the resection.
Edit the default setup limits	Check box	Check to type in values for standard deviation, position and height accuracy. If the limits are exceeded, a message is shown when Calculate is selected.
Orientation limit	Editable field	Available when Edit the default setup limits is checked. Define a limit for the standard deviation of the orientation.
Position limit	Editable field	Available when Edit the default setup limits is checked. Define a position accuracy of the target point.
Height limit	Editable field	Available when Edit the default setup limits is checked. Define a height accuracy of the target point.

Field	Option	Description
The first resection point will be used to set AR to 0.	Check box	<p>Applicable for Setup method: Resection. When this box is checked, the angle right direction is set to 0 in the direction of the first measured resection point. The values displayed for angle right during the following measurements always relate to the first measured point in the resection.</p> <p>The angle right displays the horizontal angle difference between the backsight point and the current telescope position.</p>

GS.128

P0 Instrument setup
P1 Backsight point
P2 Point in direction of current telescope position
α Azimuth
β Angle right

Next step

Orientate to object: Page changes to the **Orientate to object** page.

Settings, Orientate to object page

For **Setup method: Orientate to object**, the settings on this page apply.

Description of fields

Field	Option	Description
Position limit	Editable field	Defines a position accuracy of the target point.
Height limit	Editable field	Defines a height accuracy of the target point.
Rotations limit	Editable field	Defines a rotation accuracy for the calculation.
Shifts limit	Editable field	Defines a shift accuracy for the calculation.
Scale limit	Editable field	Defines a scale accuracy for the calculation.
Scale mode	Free	The scale factor is calculated throughout the setup routine and applied on all further transformations.

Field	Option	Description
Scale	Editable field	The user-entered scale factor. Available for Scale mode: Fixed .

Next step

Page changes to the **Report sheet** page. Refer to ".36 Apps - General"
The setup method **Orientate to object** does not support a report sheet.

50.4

Choose Setup Point

Access



A station point must be selected for **Setup method: Set orientation**, **Setup method: Known backsight**, **Setup method: Multiple backsights** and **Setup method: Transfer height**. **Choose Setup Point** is then accessed automatically from **Setup**.

Choose Setup Point

Key	Description
OK	To accept changes and return to the panel from where this panel was accessed.
Fn Settings	To configure the Setup app. Refer to "50.3 Configuring Setup".
Fn Coord	To view other coordinate properties.
Fn Scale	To activate scale correction and to type in values for the scale corrections. Refer to "New Job,TS scale page".
Fn Atmos	To type in values for the atmospheric corrections. Refer to "Atmospheric Corrections,Atmospheric ppm page".

Description of fields

Field	Option	Description
Setup point from		The selection made here determines the availability of the other fields on this panel.
	Job	A setup point can be selected from a job on a data storage device.

Field	Option	Description
	Dataset	<p>When the working job has at least one available linked job, the data for the setup can be selected from the data set.</p> <p>The option is available when all linked jobs are set to hidden or if all points in the data set are filtered out.</p> <p>The option is unavailable when the jobs in the data set are unavailable on the data storage devices.</p>
	Enter new point	<p>Pressing OK opens a panel where a new point can be typed in. After pressing Store there, the Setup app continues.</p>
	GS - Smart-Station	<p>Available when TS and GS are used. Press OK to open the GSMeasure app. After measuring a point with Measure, Stop, Store there, the Setup app continues. Refer to "54.1.2 Real-Time Rover Operations".</p> <p> In order to use GS, a coordinate system for the setup is required and must be attached to the job. If not, then a coordinate system must be selected, or local coordinates for the setup must be typed in, during the setup process.</p> <p> To obtain the correct elevation of the setup point, measure the instrument height as usual and ensure that the antenna type is set to the relevant SmartStation antenna.</p> <p> If SmartPole is used in the setup or later in Measure, remember to update the antenna type after finishing the SmartStation measurement.</p>
	Last used setup	The setup used last in the Setup app is displayed.
Job	Selectable list	The job from which the setup is selected. Refer to "6.3 Choosing a Job".
Point ID	Display only	The point ID of the setup point.
Instrument height	Editable field	The height of the instrument.
Easting, Northing and Height	Display only	The coordinates of the setup point.

Field	Option	Description
Current scale	Display only	Available when Scale TS measurements is checked in Scale Corrections . The scale according to the scale settings (Fn Scale) for the selected setup.



Refer to "24 Antenna Heights" for further information regarding height values used in a SmartStation.

50.5

Setup Details

Access

Setup information must be typed in for **Setup method: Resection**, **Setup method: Orientate to line** and **Setup method: Orientate to object**. **Setup Details** is accessed after selecting **OK** in **Total Station Setup** with one of these setup methods selected.

Setup Details

For a description of keys refer to "50.4 Choose Setup Point".

Description of fields

Field	Option	Description
Point ID	Editable field	Type in an ID for the setup point.
Instrument height	Editable field	The height of the instrument.
Point code	Selectable list	Select a point code for the setup point if desired.
Choose target points from a different job	Check box	Available for setup method Resection and Orientate to object . Target points can be selected from the design job.
Job	Selectable list	The design job from which the target points can be selected. Refer to "6.3 Choosing a Job".
Manually enter the setup height	Check box	Available for setup method Orientate to line . When this box is checked, the height value of the setup is entered and used to calculate the height of the measured points. When this box is not checked, the height of the setup is calculated relative to the first measured point. The height can be entered in Measure Target .
Setup height	Editable field	Available for setup method Orientate to line with Manually enter the setup height being checked. The elevation of the instrument setup.
Line between target 1 & 2 defines		Available for setup method Orientate to line . To define the positive North or positive East axis.

Field	Option	Description
	North axis	The second point measured defines the direction of the positive North axis.
	East axis	The second point measured defines the direction of the positive East axis.



Refer to "24 Antenna Heights" for further information regarding height values used in a SmartStation.

50.6

Setup Methods

50.6.1

Set orientation and Known backsight

Requirements

The position coordinates of the setup point are required.

For **Set orientation**: The instrument is set up and oriented to either a known or unknown target point, to which a true or assumed azimuth is set.

For **Known backsight**: The instrument is set up and oriented to a known backsight target.

For SmartStation, the position coordinates of the setup are unknown and are determined with GS. The instrument is set and oriented to either a known or unknown target point, to which a true or assumed azimuth is set.

Updating Hz measurements

A setup using the **Set orientation** method, is always automatically flagged with an 'update later' attribute. If the backsight point is measured again, for example from another setup, and found to have different coordinates, then a message appears. You can then select whether to update the original setup or not. The update uses the backsight point coordinates to recalculate the orientation and updates all measured points connected to the setup.



For information on camera and images refer to "32 Camera & Imaging".

Access

In **Total Station Setup**, select **Setup method: Set orientation** or **Known backsight**. Press **OK**.

In **Choose Setup Point**, select a setup. Press **OK**.

Set Orientation, Orientation page

Key	Description
Set	To set the setup and orientation and exit the Setup app.
Distance	To measure a distance to the point being used to set the azimuth.

Key	Description
	For Set orientation : A distance measurement is NOT required when setting the setup and the orientation with Set .
GS	For Known backsight applicable when using SmartPole. To enter the Measure panel and measure a point with GS. The antenna height is automatically converted from the target height.
Store	To store the measurement with or without a distance. Only available when Use two face measurements is selected in the Setup settings.
More	To change between the slope and the horizontal distance.
Page	To change to another page on this panel.
Fn Run / Indiv ID	Available for Setup method: Set orientation only. Run automatically chooses the next available point ID from the list of points already stored. Indiv ID to type in any value for Backsight ID .

Description of fields

Field	Option	Description
Backsight ID	Editable field	Point ID of the backsight point. For Set orientation .
	Selectable list	For Known backsight . Select a point from the points stored in the design job.
Target height	Editable field	Height of the target above or below the backsight point. The last setup target height is always remembered.
Direction	Editable field	Available for Set orientation . The direction is set to 0 by default. This value can be edited. The value is not set to the system until Set is pressed.
Horizontal distance	Display only	Available for Set orientation . Press Distance to measure a distance to the target point being used to set the azimuth.
Slope distance	Display only	Available for Set orientation . The slope distance measured between the setup point and the backsight point.
Difference in height	Display only	Available for Set orientation . The vertical distance between the setup point and the backsight point.
Computed direction	Display only	Available for Known backsight . Displays the calculated azimuth from the selected setup to the backsight point.
Computed horizontal distance	Display only	Available for Known backsight . Displays the calculated horizontal distance between the selected setup and backsight point.

Field	Option	Description
Difference in horizontal distance	Display only	Available for Known backsight . The difference between the calculated horizontal distance from setup to backsight point and the measured horizontal distance.
Computed slope dist	Display only	Available for Known backsight . Displayed after More was pressed. The calculated slope distance to the backsight point.
Difference in slope distance	Display only	Available for Known backsight . Displayed after More was pressed. The difference between the calculated slope distance from setup to backsight point and the measured slope distance.
Difference in height	Display only	Available for Known backsight . The difference between the design height of the backsight point and the measured height of the backsight point. If the backsight point is a 2D point, this field shows -----.
Angle right	Display only	Available when Hz angle display: Angle right is configured in Regional, Angle page. Displays the horizontal angle difference between the backsight point and the current telescope position.

Next step

Page changes to the **Backsight point code** page.

Set Orientation, Backsight point code page

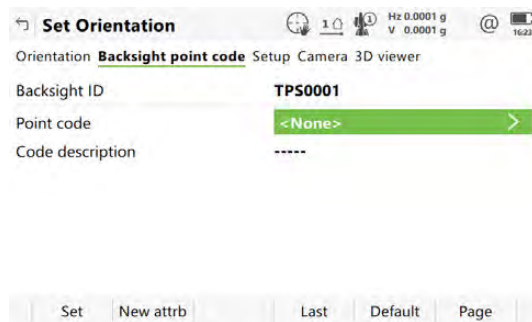

Key	Description
Set	To set the setup and orientation and exit the Setup app.
New attrb	To create more attributes for this point code.
Last	To recall the last used attribute values for the selected code.
Default	To recall the default attribute values for the selected code.
Page	To change to another page on this panel.

Description of fields

For attributes for which an attribute name can be typed in: Tap on the field of the attribute name or the field for the attribute value. The name of the attribute can be edited and an attribute value can be typed in.

Field	Option	Description
Backsight ID	Editable field or display only	Point ID of the backsight point.
Code	Selectable list	The code for the backsight point.
Code description	Display only	A short description of the code.

Next step

Page changes to the **Setup** page.

Set Orientation, Setup page

Key	Description
Set	To set the setup and orientation and exit the Setup app.
Distance	To measure a distance to the point being used to set the azimuth. A distance measurement is NOT required when setting the setup and the orientation with Set .
Store	Records displayed values temporarily. The target measurements are not stored to the current job until the setup is set. A distance measurement is not necessary before pressing Store . After recording the measurement data, the next point ID in the job is displayed. The instrument positions to the point if enough data is available and the instrument is robotic.
Scale fctr / ppm	To switch between displaying the current scale as a scale factor or ppm value.
Page	To change to another page on this panel.

Description of fields

Field	Option	Description
Point ID	Display only	ID as selected in Choose Setup Point .
Instrument height	Editable field	The instrument height.
Point code	Selectable list	The code for the backsight point.
Current PPM / Current scale	Display only	The current job scale. Refer to "New Job, TS scale page" for more information on scale corrections.

Next step

Page changes to the **3D viewer** page.

50.6.2

Multiple backsights

Requirements

The position coordinates of the setup point are required. The instrument is set up and oriented to one or more known backsight targets.

For SmartStation, the position coordinates of the setup are unknown and are determined with GS. The instrument is set up and oriented to one or more known backsight targets.

For TS and SmartStation, the orientation is determined by sighting to one or more known target points. Ten target points is the maximum. Only angles or both angles and distances can be measured. The height of the setup point can also be derived from the target points.



For information on camera and images refer to "32 Camera & Imaging".

Access

In **Total Station Setup**, select **Setup method: Multiple backsights**. Press **OK**.

In **Choose Setup Point**, select a setup. Press **OK**.

Measure Target

Unless otherwise stated the following panel and description applies to the setup methods: **Multiple backsights**, **Transfer height**, **Resection**, **Orientate to line** and **Orientate to object**.

Measure Target 1

Target Camera

Point ID: TPS0001

Target height: 0.000 m

Hz angle: 0.0004 g

V angle: 0.0002 g

Slope distance: -----

Difference in azimuth: -----

Difference in horizontal distance: -----

Measure Distance Store Page

Key	Description
Measure	To measure and store the distances and angles made to the control points. After storing the measurement data, the next point ID in the job is displayed. The instrument positions to the point if enough data is available.
Distance	To measure and display distances.
Store	Records displayed values temporarily. The target measurements are not stored to the current job until the setup is set. A distance measurement is not necessary before pressing Store . After recording the measurement data, the next point ID in the job is displayed. The instrument positions to the point if enough data is available and the instrument is robotic.



The setup method **Orientate to object** requires valid distance measurements before using **Store**.

Key	Description
GS	Applicable when using SmartPole. To enter the Measure panel and measure a point with GS. The antenna height is automatically converted from the target height.
Done	For Resection only. To exit the Setup app temporarily. The setup is incomplete but can be continued later. This softkey changes to Calculate when sufficient data is available.
Calculate	<p>For Multiple backsights: Available after the first measurement. You can see the calculated setup orientation and other results.</p> <p>For Resection: Available after measuring two target points or as soon as a preliminary setup and orientation can be calculated. The calculated setup coordinates and overall "quality" of the results are displayed.</p> <p>For Orientate to object: Available after measuring three or more target points. The calculated setup coordinates and overall "quality" of the results are displayed.</p>
Fn Find	<p>Stakeout values are provided to guide the prism holder to the selected target point.</p> <p>For Resection and Orientate to object, this key becomes available once sufficient data is available for calculation. Refer to "50.8 Finding a Target Point".</p>
Fn Position	<p>To position the instrument to the selected target point.</p> <p>For Resection: Available once sufficient data is available for calculation.</p>

Description of fields

Field	Option	Description
Point ID	Selectable list	The point ID of the target point to be measured.
Target height	Editable field	The height of the target above or below the backsight point. The last setup target height is always remembered.
Angle right	Display only	Available when Hz angle display: Angle right is configured in Regional, Angle page. Displays the horizontal angle difference between the backsight point and the current telescope position.
V angle	Display only	The current vertical angle.
Slope distance	Display only	The measured slope distance after Distance was pressed.
Difference in horizontal distance	Display only	The difference between the calculated and the measured horizontal distance.
Difference in height	Display only	The difference between the given and the measured height of the target point.

Field	Option	Description
Easting and Northing	Editable field	Available for Orientate to line . The coordinates of the first target point. Editing the coordinates shifts the origin of the coordinate system.
Height	Editable field	Available for setup method Orientate to line when Manually enter the setup height is not checked in Setup Details . The height of the first measured point. The height of the setup is calculated relative to the first measured point.
Difference in azimuth	Display only	Displays the difference between the calculated azimuth and the current horizontal angle. If Setup method: Resection or Setup method: Orientate to object , displays ----- until at least 3 target points are measured.



A maximum of ten target points can be measured and used for the calculation. When the maximum number of points is exceeded, a message will appear. The user can remove previous points or finish the setup. Points can be removed from the **Setup Results, Targets** page.

50.6.3

Transfer height

Requirements

This method is used to compute a setup height to apply to the selected setup. Only the height is updated, the orientation is not updated. The position coordinates of the setup point are required.

Access

In **Total Station Setup**, select **Setup method: Transfer height**. Press **OK**. In **Choose Setup Point**, select a setup. Press **OK**.



For a description of the **Measure Target** panel, refer to "50.6.2 Multiple back-sights".

50.6.4

Resection

Requirements

The coordinates of the setup point are unknown. The coordinates and orientation are determined by sighting to at least two or more known target points. Ten target points is the maximum. Only angles or both angles and distances can be measured. For a resection, least squares or robust calculations are used. The resection calculations can be done using the Helmert method, robust method or least squares method, after three measurements to known back-sights have been completed.

Access

In **Total Station Setup**, select **Setup method: Resection**. Press **OK**. In **Setup Details**, type in the required information. Press **OK**.



For a description of the **Measure Target** panel, refer to "50.6.2 Multiple back-sights".

50.6.5

Orientate to line

Description

This method can be used to calculate the 2D or 3D local coordinates for the instrument setup and the orientation of the horizontal circle. The calculation is done using the distance and angle measurements to two target points.

The first target point defines the origin of the local coordinate system. The first target point can be measured or selected from the job.

The line between the first and the second target point defines, depending on the working style, the local direction of North, East or a User defined direction.

The coordinates of the first target point can be changed in the **Measure Target** screen. Editing the coordinates shifts the origin of the coordinate system.

Requirements

All coordinates calculated are local coordinates.

Access

In **Total Station Setup**, select **Setup method: Orientate to line**. Press **OK**.

In **Setup Details** type in the required information. Press **OK**.



For a description of the **Measure Target** panel, refer to "50.6.2 Multiple back-sights".

50.6.6

Orientate to object

Description

This method is used to set up the instrument referring to an arbitrary object coordinate system.

The object coordinate system is defined by at least three known points having 3D coordinates. The station coordinates are unknown. To set up the instrument, distance and angle measurements to at least three known 3D target points must be performed.

After a successful setup, the station coordinates and all subsequently measured points are referring to the object coordinate system.

The position values Easting and Northing are related to the X/Y plane of the object coordinate system. The height component refers to the Z-axis.



In contrast to the coordinates, the observation values do not have to refer to the object coordinate system, as the Z-axis does not have to be parallel to the plumb line.



Reflector heights always refer to the plumb line. Since the plumb line does not have to coincide with the Z-axis, changing the reflector height can lead to changes in all three coordinate components (E, N, H).



Apps which cannot be used when this setup method was used are:

- Stake road
- Check road
- Stake rail
- Check rail
- Stake tunnel
- Check tunnel
- Meas plane/grid
- Traverse
- Measure sets
- TS hidden point
- COGO Intersection method Two TS observations



Measure Foresight from the toolbox for apps cannot be used when this setup method was used.

Requirements

- The measured setup points must have 3D coordinates. 1D (height only) or 2D (position only) coordinates are not allowed.
- Distances must be measured to at least three target points.
- The scale factor of 1 is used. A user defined scale factor is ignored. To check the current scale factor select **Current setup** in the **Instrument**. The scale factor is defined on the **TS scale** page when creating or editing a job.

Access

In **Total Station Setup**, select **Setup method: Orientate to object**. Press **OK**.

In **Setup Details** type in the required information. Press **OK**.



For a description of the **Measure Target** panel, refer to "50.6.2 Multiple backsights".

50.7

Setup Results

Description

The results panel is displayed after pressing **Calculate** in the **Measure Target** panel. The results panel is part of the **Multiple backsights**, **Transfer height**, **Resection**, **Orientate to line** and **Orientate to object** setup methods.

After three measurements to known targets, the calculations can be done using the robust method or the least squares method. For **Resection**, the calculations can also be done using the Helmert method. For **Orientate to object**, the calculations are always done using the robust method. For **Orientate to line**, no adjustment is applicable.

After the setup is set, all following measurements will be related to this new setup and orientation.



For information on camera and images refer to "32 Camera & Imaging".

Setup Results, Results page

The screenshot shows the 'Setup Results' page with the following data:

New height	99.996 m
Old height	100.000 m
Difference in height	0.004 m
Height quality (1 σ)	0.003 m

Use the new height for this setup

At the bottom, there is a table with the following content:

Fn	Set	Robust	Page	Fn
----	-----	--------	------	----

Key	Description
Set	To set the orientation, to store all setup data and exit the app. For Transfer height : To store all setup data and exit the app.

Key	Description
Done	To exit the setup without setting it, the setup is incomplete.
Robust or Least Sqrs	To display the results for the robust or the least squares calculation method. Available for setup method Resection .
Page	To change to another page on this panel.
Fn 3 param or Fn 4 param	Switches between a 3 parameter and 4 parameter calculation. For 3 parameter, the current scale is not applied to setup observations for a new setup calculation. For 4 parameter, the current scale is applied. The setup coordinates are automatically updated according to the setting used. Defaults to 4 parameter. Available for setup methods Resection .
Fn Params	To access Parameters . Available for setup method Orientate to object .
Fn Add target	To access Measure Target and to measure more target points.
Fn Scale	To access Scale Corrections . Refer to "New Job,TS scale page". Available for setup method Resection .
Fn Scale fctr or Fn ppm	To display the scale results by scale factor or as a ppm value. Available for setup method Resection .

Description of fields

Field	Option	Description
New orientation	Display only	New oriented azimuth with running angle as telescope moves. Unavailable for setup methods Transfer height and Orientate to object .
Angle right	Display only	Available when H_z angle display: Angle right is configured in Regional, Angle page. Displays the horizontal angle difference between the backsight point and the current telescope position.
Difference in height	Display only	The difference between the new calculated height and the old height. Available for setup methods Multiple backsights and Transfer height .
Use the new height	Check box	For setup method Multiple backsights : When this box is checked, both orientation and height are updated. If not checked, only the orientation is updated. For setup method Transfer height : When this box is checked, the setup height is updated. If not checked, the setup height does not change. Not available for any other setup methods.

Field	Option	Description
New height	Display only	The calculated height is displayed. Available for setup methods Multiple backsights and Transfer height .
Old height	Display only	The original height is displayed. Available for setup methods Multiple backsights and Transfer height .
Height quality (1 σ)	Display only	Standard deviation of the calculated setup height. Available for setup methods Transfer height .
Easting	Display only	The calculated Easting is displayed. Available for setup methods Resection, Orientate to line and Orientate to object .
Northing	Display only	The calculated Northing is displayed. Available for setup methods Resection, Orientate to line and Orientate to object .
Height	Display only	The calculated Height is displayed. Available for setup methods Resection, Orientate to line and Orientate to object .
Apply the computed height for this setup	Check box	When this box is checked, then the height from the solution is set as the setup height. When this box is not checked, then the height is not updated. Available for setup method Resection .
New orientation	Display only	The calculated orientation is displayed. Available for setup methods Orientate to line .

Next step

Page changes to the **Setup** page.

Setup Results, Setup page

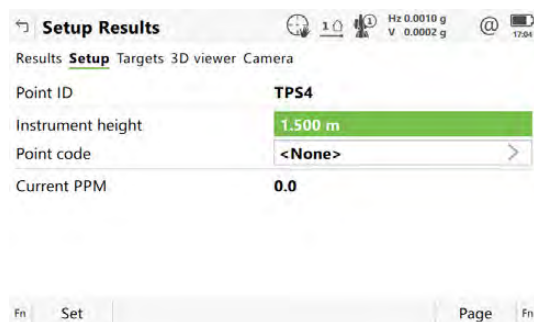

Key	Description
Set	To set the orientation, to store all setup data and exit the app. For Transfer height : To store all setup data and exit the app.
Done	To exit the setup without setting it, the setup is incomplete.

Key	Description
Scale	To type in values for the scale corrections. Refer to "New Job,TS scale page". Unavailable for setup methods Transfer height and Orientate to object .
ppm/Scale fctr	To switch between displaying the setup scale factor and the setup ppm.
Page	To change to another page on this panel.
Fn 3 param or Fn 4 param	Switches between a 3 parameter and 4 parameter calculation. For 3 parameter, the current scale is not applied to setup observations for a new setup calculation. For 4 parameter, the current scale is applied. The setup coordinates are automatically updated according to the setting used. Defaults to 4 parameter. Available for setup method Resection .

Description of fields

Field	Option	Description
Point ID	Display only	ID of the current setup.
Instrument height	Editable field	The current instrument height.
Point code	Selectable list	Select a point code for the setup point if desired.
Current PPM / Current scale	Display only	The current job scale. Refer to " New Job,TS scale page" for more information on scale corrections.

Next step

Page changes to the **Quality** page.

Setup Results, Quality page

For a description of the softkeys refer to "Setup Results,Setup page".

This page is not available for setup methods **Transfer height** or **Orientate to line**.

Description of fields

Field	Option	Description
New orientation	Display only	New oriented azimuth with running angle as telescope moves. Available for setup method Multiple backsights .
Difference in height	Display only	Delta height, the difference between original and calculated height. Available for setup method Multiple backsights .

Field	Option	Description
Easting quality (1 σ)	Display only	Standard deviation of the calculated setup Easting. Available for setup methods Resection and Orientate to object .
Northing quality (1 σ)	Display only	Standard deviation of the calculated setup Northing. Available for setup methods Resection and Orientate to object .
Height quality (1 σ)	Display only	Standard deviation of the calculated setup height.
New orientation quality (1 σ)	Display only	Standard deviation of the calculated orientation.

Next step

Page changes to the **Targets** page.

Setup Results, Targets page

This panel displays information about the accuracy of the measured target points and allows exclusion of measurements from the calculation.

Extra measurements can be made and measurements can be deleted.

This page is not available for setup method **Orientate to line**.

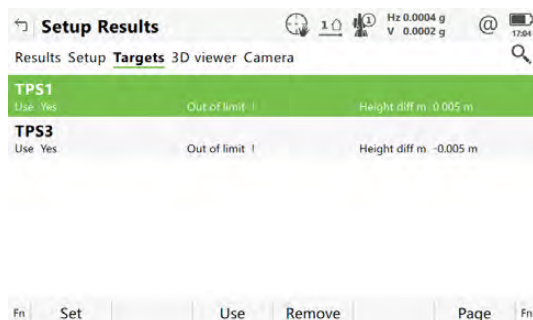

Key	Description
Set	To set the calculated setup for all setup methods. The setup values are updated automatically if target points are added or removed.
Use	To change between using the selected point as 3D, 2D, 1D or not at all, in the calculation. The change automatically updates any new coordinate or orientation values. For setup method Orientate to object : To set Yes or No in the metadata for excluding/including the highlighted point for the calculation.
Remove	To delete a point from the list of measured target points and exclude it from the Setup calculation.
More	To change the metadata displayed.
Page	To change to another page on this panel.

Description of metadata

Metadata	Description
-	The point ID of the measured target points.
Out of limit	The Out of limit indicates that the delta value of either measured horizontal angle, distance or height exceeds the calculation limit. Unavailable for Orientate to object .
Use	Indicates if and how a target point is used in the setup calculation. Choices are 3D , 2D , 1D and No .
Hz diff	Difference between calculated and measured horizontal angle for the target points. If a target point does not have coordinates, ----- are displayed. Differences exceeding the defined limit are indicated by Out of limit .
Distance diff	Difference between calculated and measured distance from the setup to the target points. If a target point does not have coordinates, ----- are displayed. Differences exceeding the defined limit are indicated by Out of limit .
Height diff	Difference between the known control point height and the measured height of the target point. If a target point does not have a height coordinate, ----- are displayed. Differences exceeding the defined limit are indicated by Out of limit .
Easting diff	Difference between control point and measured point, calculated from new setup coordinates.
Northing diff	Difference between control point and measured point, calculated from new setup coordinates.

Next step

Page changes to the **3D viewer** page.

50.8

Finding a Target Point

Description

The **Find Target** panel can be accessed, to guide the prism to the selected target point.

The panel is only available if the Stakeout app is available on the instrument.

The functionality of this panel is similar to a stakeout routine and is intended to help find hidden survey bench marks or base points.

Access

Press **Fn Find** in **Measure Target** once enough data is available to calculate roughly the new orientation.

Find Target

This panel is similar to the **Stake Points**,  page and is configured through the **Stake Points** settings. Refer to "Stake Points,page" for a detailed description of this panel.

51

Stakeout

51.1

Overview

Description

The Stakeout app is used to place marks in the field at predetermined points. These predetermined points are the points to be staked. The points to be staked can

- be uploaded to a job on the instrument using Infinity.
- exist in a job on the instrument.
- be uploaded from an ASCII file to a job on the instrument. Use **Import data\ASCII** from the job menu.

Diagram

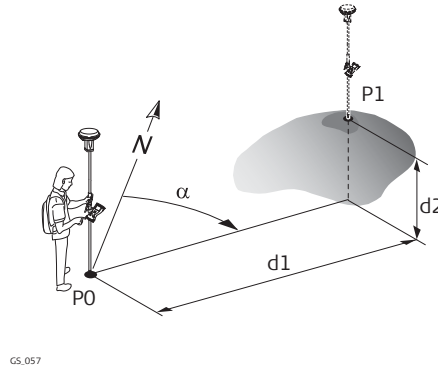

GS:

- P0 Current position
- P1 Point to be staked
- d1 Stakeout distance
- d2 Height difference between current position and point to be staked
- α Stakeout direction

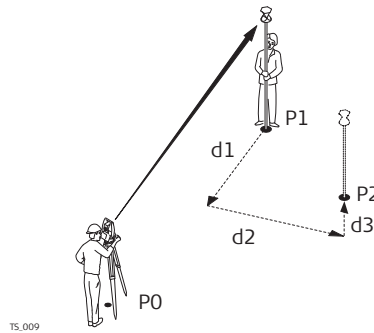

TS:

- P0 Setup
- P1 Current position
- P2 Point to be staked
- d1 Stakeout element
- d2 Stakeout element
- d3 Stakeout element

Stakeout modes

Points can be staked using different modes:

- Polar mode.
- Orthogonal mode.



Staking out is possible for RTK rover and TS.



The points to be staked must exist in a job on the active memory device or can be typed in.

Linked jobs and global data

Linked jobs will overwrite the points and lines from the global design job selected in **Design Data**.

Coordinate system	If staking local grid points with GNSS, always ensure that the correct coordinate system is being used. For example, if the points to be staked are stored in WGS 1984, the active coordinate system must also be WGS 1984.	
Point types	It is possible to stake: <ul style="list-style-type: none"> • Position only points. • Height only points. • Points with full sets of coordinates. 	
Height types	Height type of the point to be staked:	Orthometric OR ellipsoidal
	Height type computed for current position:	Orthometric OR ellipsoidal depending on the <ul style="list-style-type: none"> • configured transformation, • availability of a geoid model, • height type of the point to be staked. If possible, the height type of the point to be staked is computed for the current position.
Height source	Heights can be taken into account from <ul style="list-style-type: none"> • the vertical component of a coordinate triplet. • a Digital Terrain Model. The DTM licence key must be loaded. Refer to "29.3 Load licence keys" for information on how to enter the licence key. If loaded, the height of the points to be staked can be edited in the field.	
Coding of staked points	Codes can be attached to staked points. The behaviour of the coding functionality depends on the definition of a page with editable fields for coding and attributes.	
Averaging of staked points	The principles for averaging are identical to the averaging principles of the Measure app.	
51.2	Accessing Stakeout	
Access	Select Leica Captivate - Home: Stake points .	
	The points to be staked are stored in the selected design job. Points which are measured during staking out are stored in the selected job.	
51.3	Configuring Stakeout	
Access	Select Leica Captivate - Home: Stake points . Press Fn Settings .	

Settings, General page

This panel consists of several pages. The explanations for the softkeys given here are valid for all pages, unless otherwise stated.

Key	Description
OK	To accept changes and return to the panel from where this panel was accessed.
Page	To change to another page on this panel.
Fn About	To display information about the program name, the version number, the date of the version, the copyright and the article number.

Description of fields

Field	Option	Description
Automatically select next closest point	Check box	The order of the points suggested for staking out. When this box is checked, then the next point suggested for staking out is the point closest to the point which was staked. If there are many points in the job, the search can take a few seconds. When this box is not checked, the next point suggested for staking out is the subsequent one in the job.
Store point with	Design point ID	The staked points are stored with the same point IDs as the points to be staked.
	Design point ID & prefix	Adds the setting for Prefix / suffix in front of the original point IDs.
	Design point ID & suffix	Adds the setting for Prefix / suffix at the end of the original point IDs.
	Individual point ID	The staked points are stored with an alphanumeric point ID entered.
Prefix / suffix	Editable field	Available for Point ID: Design point ID & prefix and Point ID: Design point ID & suffix . The identifier with up to four characters is added in front of or at the end of the ID of the staked point.

Field	Option	Description
View results page after staking a point	Check box	When this box is checked, the stake results are displayed after staking a point.

Next step

Page changes to the **Graphics** page.

Settings, Graphics page

Description of fields

Field	Option	Description
Help me navigate		The reference direction to be used to stakeout points. The stakeout elements and the graphical display shown in the Stake app are based on this selection.
	From behind instrument	For TS: The direction of the orientation is from the instrument to the point to be staked.
	Facing instrument	For TS: The direction of the orientation is from the current position relative to the instrument.
	Facing last measured point	The direction of the orientation is from the current position relative to the last recorded point. If no points are yet staked, Help me navigate: Facing north is used for the first point to be staked.
	Facing point (design data)	The direction of the orientation is from the current position relative to a point from the design job.
	Facing point	The direction of the orientation is from the current position relative to a point from the job.
	Using base line (design)	The direction of the orientation is parallel to a baseline from the design job. Open the drop-down list to create, edit or delete a baseline.
	Using base line	The direction of the orientation is parallel to a baseline from the job. Open the drop-down list to create, edit or delete a baseline.
	Facing north	The direction of the orientation is from the current position relative to North

Field	Option	Description
	Following arrow	The direction of the orientation is from the current moving direction to the point to be staked. The graphical display shows an arrow pointing in the direction of the point to be staked. The current position must have moved at least 0.5 m for the orientation to be calculated.
	Facing sun	For GS: The position of the sun calculated from the current position, the time and the date.
Point ID or Base line	Selectable list	Available for Help me navigate: Facing point (design data) , Help me navigate: Facing point , Help me navigate: Using base line and Help me navigate: Using base line (design) . To select the point or line to be used for orientation.
Navigational arrow types		The method of staking out.
	Direction & distance	The direction from the orientation reference, the horizontal distance and the cut/fill are displayed.
	In/out, left/right	The distance forwards to/backwards from the point, the distance right/left to the point and the cut/fill is displayed.
Switch to bulls eye when 0.5m (1.5ft) from point	Check box	When this box is checked, a bulls eye bubble is shown in the stake-out graphic when less than half a metre from the point being staked.
Beep faster when getting close to point	Check box	The instrument beeps when the distance from the current position to the point to be staked is equal to or less than defined in Start within . The closer the instrument is to the point to be staked the faster the beeps are.
Distance to use	Height, Horizontal distance or Position & height	Available when Beep faster when getting close to point is checked. The type of distance to use for staking.

Field	Option	Description
Start within	Editable field	Available when Beep faster when getting close to point is checked. The horizontal radial distance, from the current position to the point to be staked.

Next step

Page changes to the **Quality control** page.

Settings, Quality control page

Description of fields

Field	Option	Description
Check differences before storing	Check box	Allows a check to be made on the horizontal and vertical difference between the staked point and the point to be staked. If the defined limit is exceeded, the stake out can be repeated, skipped or stored.
Differences to check	Position, Height or Position & height	The type of differences to be checked before storing a point.
Position limit	Editable field	Available when Check differences before storing is checked. Sets the maximum horizontal coordinate difference accepted in the position check.
Position limit	Editable field	Available when Check differences before storing is checked. Sets the maximum vertical difference accepted in the height check.
Prompt off-setting annotation	Check box	Available for the Seismic stakeout app. When this box is checked, a specific annotation must be entered when the current staked point is out of distance tolerance. This annotation is stored as annotation 1.

Next step

Page changes to the **Heights** page.

Settings, Heights page

Description of fields

Field	Option	Description
Allow editing the height of the selected point	Check box	When this box is checked, the value for Design height displayed in Stake Points ,  page, can be changed. The design height is the height of the point to be staked. When this box is not checked, the value for Design height cannot be changed.

Field	Option	Description
Apply offset to height of all points being staked	Check box	Allows a constant height offset to be applied to the height of the points being staked.
Height off-set	Editable field	The height offset that is applied.





Next step

Page changes to the **Info** page.

Key	Description
OK	To accept changes and to return to previous panel.
Clear	To set all fields to Unused line .
Fn Default	To recall the default settings.

Description of fields

Field	Option	Description
Show user defined page	Check box	The user-defined page to be shown in the Stake Points panel.
Page to show	Selectable list	The names of the available pages.
1st line	Display only	Fixed to Point ID .
2nd line to 16th line		For each line, one of the following options can be selected.
	Separator and Unused line	Empty line.
	Point ID	Editable field for the point ID.
	Target height	Editable field for prism height.
	Code	Editable field for codes.
	Code description	Display only field for the description of codes.
	Attribute 01 to Attribute 02	Editable field for attributes for codes.
	Height difference	Display only field for the vertical offset between the defined position and the current position.
	Direction to point	Display only field for the direction from the current position to the point to stakeout.
	Distance to point	Display only field for the distance from the current position to the point to stakeout.

Field	Option	Description
	Design East	Display only field for the Easting of the design point.
	Design North	Display only field for the Northing of the design point.
	Design height	Display only field for the height of the design point, depending on the defined heights to use.
	Easting	Display only field for the Easting coordinate of measured point.
	Northing	Display only field for the Northing coordinate of measured point.
	Height	Display only field for the height coordinate of the measured point.
	3D quality	Display only field for the current 3D coordinate quality of computed position.
	Cut/fill	Display only field for the height difference between the design height and the measured height.
	Go forward/backward	Distance to point. Available for staking. For Navigational arrow types: In/out, left/right in 3D viewer equivalent to: 
	Go left/right	Distance to point. Available for staking. For Navigational arrow types: In/out, left/right in 3D viewer equivalent to: 
	Go	Distance to point. Available for staking. For Navigational arrow types: Direction & distance in 3D viewer equivalent to: 
	Turn left/right	Direction to point. Available for staking. For Navigational arrow types: Direction & distance in 3D viewer equivalent to: 

Field	Option	Description
	Difference in easting	Display only field for the difference in Easting between the current position and the point to stakeout.
	Difference in northing	Display only field for the difference in Northing between the current position and the point to stakeout.

Next step

Page changes to the **TS specific** page.

Settings, TS specific page

Description of fields

Field	Option	Description
Do not update stakeout values between distance measurements	Check box	When this box is checked, angles and stakeout values are updated after a distance was measured. Then all values are frozen until the next distance is taken.
Automatically aim instrument to point being staked	Check box	When this box is checked, the instrument positions automatically to the point to be staked.
Automatic behaviour		Available when Automatically aim instrument to point being staked is checked.
	Position only	Instrument positions horizontally to the point to be staked.
	Position & height	Instrument positions horizontally and vertically to the point to be staked.
Show direction & distance when selecting a new point to be staked		For each point which is selected for staking, angle and distance information is momentarily displayed in the message line.
	Instrument	The delta horizontal angle that the instrument must turn to the point, and the distance from the instrument to the point, is displayed in the message line.
	Last staked point	The delta horizontal angle that the instrument must turn to the point, and the distance from the last staked point, is displayed in the message line.

Field	Option	Description
Measure all points in two faces	Check box	To take a measurement in Face I and Face II. The point stored is an average of the two measurements. When an instrument is fitted with auto aiming, the point is automatically measured in both faces. The resulting point is stored and the instrument is returned to the first face.

Next step

Page changes to the **Report sheet** page. Refer to "36 Apps - General".

51.4

Staking Out

Diagram

This diagram shows an example for **Navigational arrow types: In/out, left/right**.

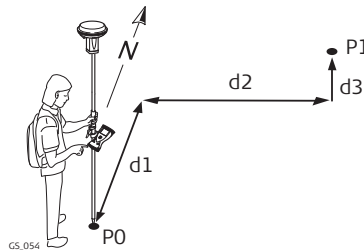

For GS:

- P0 Current position
- P1 Point to be staked
- d1 Forwards or backwards
- d2 Right or left
- d3 Fill or cut

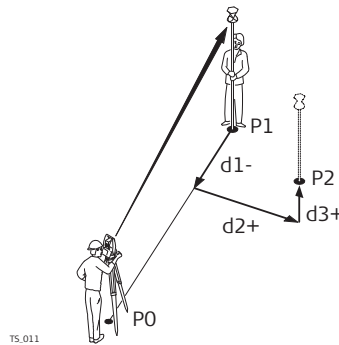

For TS:

- P0 Setup
- P1 Current position
- P2 Point to be staked
- d1 Forward or backwards
- d2 Right or left
- d3 Cut or fill

This diagram shows an example **Navigational arrow types: Direction & distance**.

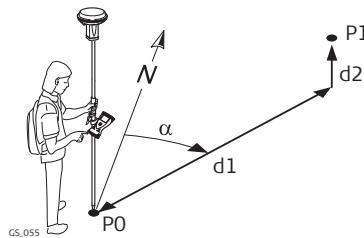

For GS and TS:

- P0 Current position
- P1 Point to be staked
- d1 Distance
- d2 Cut or fill
- α Direction

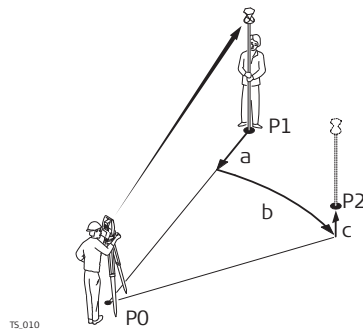

**For TS with Help me navigate:
From behind instrument:**

- P0 Setup
- P1 Current position
- P2 Point to be staked
- a Distance
- b Horizontal angle
- c Cut or fill



For information on camera and images refer to "32 Camera & Imaging".

Stake Points, page

The pages shown are from a typical working style. An extra page is available when a user-defined page is used.

The selected view of the 3D viewer is the one last used,

- when leaving the app and returning to it.
- when turning off and on the instrument.

For an explanation of the graphical symbols refer to "35.4.4 Orientation Information for Stakeout".

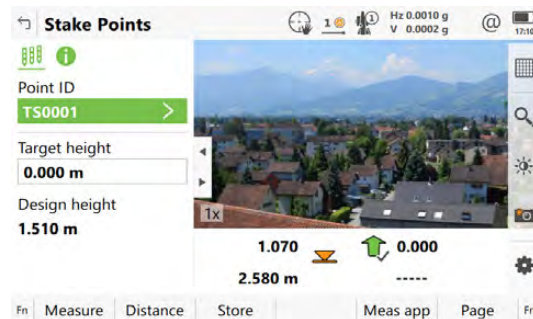

Key	Description
Measure	<p>For GS: To start measuring the point being staked. The key changes to Stop. The difference between the current position and the point being staked is still displayed.</p> <p>For TS: To measure a distance and store distance and angles.</p>
Stop	<p>For GS: To end measuring the point being staked. When Automatically stop point measurement is checked in GS Quality Control, General page recording of positions ends automatically as defined by the stop criteria. The key changes to Store. After ending the measurements, the differences between the measured point and the point to be staked are displayed.</p>

Key	Description
Store	For GS: To store the measured point. When Automatically store point is checked in GS Quality Control, General page, the measured point is stored automatically. The key changes to Measure . For TS: To store angles and distance. Distance must be measured before.
Distance	For TS: To measure a distance.
Flip view or Flip view	To reverse the graphical display top to bottom. A reversed graphical display can be used when the point to be staked lies behind the current position.
Meas app	To measure more points which may be needed during staking out. Available when Measure is displayed.
Page	To change to another page on this panel.
Fn Settings	To configure the Stakeout app. Refer to "51.3 Configuring Stakeout".
Fn Display	To configure what is displayed in the 3D viewer.
Fn Connect and Fn Dis-connect	For GS: To connect/disconnect from the GPS reference data.

Description of fields

Field	Option	Description
Point ID	Selectable list	The point ID of the point to be staked.
Antenna height	Editable field	For GS: The antenna height. Changes in the antenna height do not update the antenna height as defined in the active working style. The changed antenna height is used until the app is exited.
Target height	Editable field	For TS: The prism height.
Design height	Display only	Available when Allow editing the height of the selected point is not checked in Settings, Heights page.
	Editable field	Available when Allow editing the height of the selected point is checked in Settings, Heights .

Field	Option	Description
		<p>The design height, which is the orthometric height of the point to be staked, is displayed. If the orthometric height cannot be displayed, the local ellipsoidal height is displayed. If it is not possible to display the local ellipsoidal height, the WGS 1984 height is displayed. The value for Height offset configured in Settings, Heights page is not taken into account.</p> <p>Changing the value for Design height changes the values displayed for cut and fill.</p>
-	-	<p>The orthometric height of the current position is displayed with the stake height difference in the stakeout graphics. If the orthometric height cannot be displayed, the local ellipsoidal height is displayed. If it is not possible to display the local ellipsoidal height, the WGS 1984 height is displayed. The value for Height offset configured in Settings, Heights page is taken into account.</p>

Stake Results, General page

If **View results page after staking a point** is checked in **Settings, General** page, this panel opens automatically once a point is measured and stored.

Key	Description
OK	To return to the stake panel.
Page	To change to another page on this panel.

Description of fields

Field	Option	Description
Design point ID	Display only	The point ID of the design point.
Store staked point as	Editable field	The point ID of the point staked.
Design height	Display only	The entered design elevation.
Measured height	Display only	The height measured at the stored point.
Cut/Fill	Display only	The height difference between the Design height and the Measured height .
2D distance	Display only	Displays the horizontal difference from the staked point to the point to be staked.
3D distance	Display only	Displays the spatial difference from the staked point to the point to be staked.

Stake Results, Elevations page

Next step

Page changes to the **Coords** page. This page displays the design coordinates as well as the differences between design and measured coordinates.

Page changes to the **Code** page where codes can be selected or typed in.

Page changes to the **Elevations** page.

On this page, multiple elevations can be stored to one staked point.

Example

When measuring the centre of a manhole, the drain below may have pipelines joining at different height levels. To store and stakeout these pipeline inverts, additional heights can be entered. The cut and fill value will automatically be calculated, allowing to transfer this information to the stake marker.

Key	Description
OK	To return to the stake panel. To store all values.
Last	To recall the last stored elevations and information.
Page	To change to another page on this panel.

Description of fields

Field	Option	Description
Elevation	Editable field	The entered elevation is stored with the point and used to calculate the cut and fill values.

Cut/Fill	Display only	Height of the point being stored - Entered elevation ----- = Cut or fill value (always positive)
----------	--------------	---

Examples

For cut:

Height of the point being stored
- Entered elevation

Result > 0

598.5672 m - 596.4856 m = 2.0816 m = cut
The displayed value is 2.0816 m.

For fill:

Height of the point being stored
- Entered elevation

Result < 0

598.5672 m - 599.7826 m = -1.2154 m = fill
The displayed value is 1.2154 m.

Field	Option	Description
Information	Editable field	Additional information that must be stored with the elevation. Only the entered Information which also has an entered elevation is stored to the point being stored.

51.5

Stakeout Difference Limit Exceeded

Description

If configured a check is made on the horizontal and/or vertical coordinate distance from the staked point to the point to be staked. Refer to "51.3 Configuring Stakeout" for information on configuring the check and the limits.

Access

If either of the configured difference limits are exceeded, a warning is displayed automatically when the point is stored.

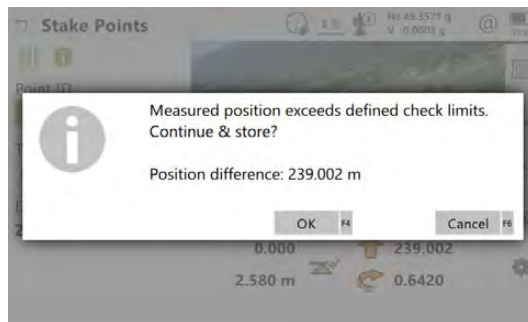

Key	Description
Cancel	To return to the Stake Points panel without storing the point. Staking out of the same point continues.
OK	To accept the coordinate differences, store the point information and return to the Stake Points panel.

51.6

Staking Out a DTM or Points & DTM

Description

A **Digital Terrain Model** can be staked alone or together with points. The heights of the current positions are compared against the heights of a selected DTM job. The height differences are calculated and displayed.

Staking a DTM can be used for

- staking out where the DTM represents the surface to be staked.
- quality control purposes where the DTM represents the final project surface.

DTM jobs are created in Infinity or imported from a file or created in the **Volume calc** app. DTM jobs are stored in the \DBX directory on the active data storage device.

Diagram

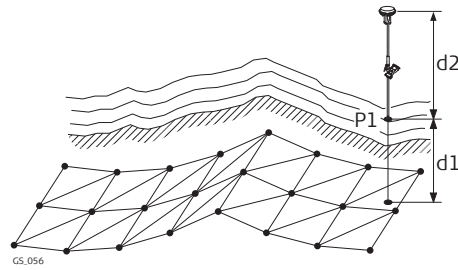

For GS:

- P1 Point to be staked
- d1 Cut or fill
- d2 Antenna height

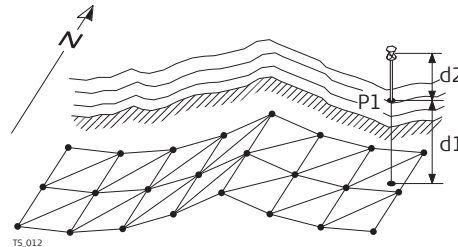

For TS:

- P1 Point to be staked
- d1 Cut or fill
- d2 Reflector height

Access

If the message panel appears which requires that the app must be activated using a licence key then refer to "29.3 Load licence keys".

To stake out DTM heights only:

Select **Leica Captivate - Home: Stake DTM**.

To stake out positions of points and DTM heights:

Select **Leica Captivate - Home: Stake pts & DTM**.



The positions of points to be staked are stored in the selected design job.

Points which are measured during staking out are stored in the selected job.

Heights to be staked out are taken from the selected DTM job.

The DTM job to be used must be stored in the \DBX directory on the active data storage device.

Heights without positions are staked out relative to the selected DTM job.



The stakeout procedure is identical as for the normal Stakeout app but the heights to be staked are taken from the selected DTM job. The negative or positive height differences from the current position to the equivalent point in the selected DTM job is calculated and displayed. Height offsets apply.

52.1

Overview

Description

The Seismic Stakeout app includes all the standard stakeout functionality plus extra features that are specific to seismic survey. It supports exclusion zone files in order to warn users when the selected preplot point position or the current measured position falls inside a protected area. It provides a specific page in the main stakeout panel to help staking, offsetting or skidding preplot points. A "default line width annotation" feature is available for users who need to report the width of the cut line.

Terms

Term	Description
Exclusion zone	Protected area where drilling is not allowed.
Preplot	Refers to design. For example preplot points and preplot job - instead of design points or design data job.
Track and bin	The preplot point IDs are comprised of a track(line) and bin(station). For example, if the point ID 162304 has 3 bin characters then its track would be 162 and its station 304.

52.2

Accessing Stakeout

Access

Select **Leica Captivate - Home: Seismic stakeout**.

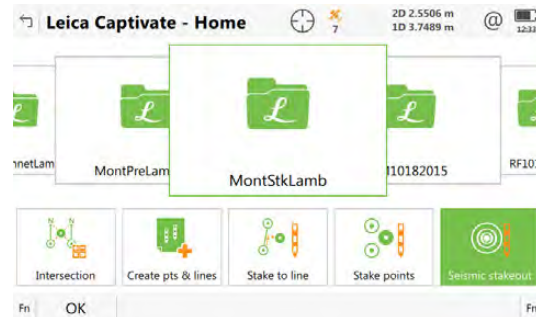

Design Data

This panel is displayed when **Choose design data when starting app which uses design data** is checked in **Settings**.

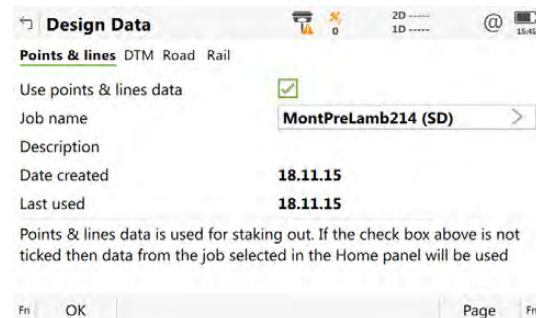

Key	Description
OK	To accept the selected job.
Page	To change to another page on this panel.
Fn Settings	To activate or deactivate job selection at the beginning of an app.

Description of fields

Field	Option	Description
Use points & lines data	Check box	When this box is checked, a separate design job can be selected. The design data refers to pre-plot points in the Seismic Stakeout app. The selected design job is visible in 3D viewer.
Job name	Selectable list	Preplot points job
Description	Display only	The detailed description of the job.
Date created	Display only	The date of when the job was created.
Last used	Display only	The date of when the job was last accessed.

Choose Exclusion Zone

Key	Description
OK	To validate the selected exclusion zone file. Opens the Define Line Settings panel. The file is converted to an internal format (*.xnz) when used for the first time.
Display	To open the Exclusion zone viewer after loading the zones in memory. The file is converted to an internal format (*.xnz) when used for the first time. Refer to "Exclusion zone viewer".
Fn Settings	To configure Seismic Stakeout app.

Description of fields

Field	Option	Description
File type	ESRI SHP	Polygon shapefile in local grid coordinate system. The current system's units must be the same as the shapefile when used for the first time otherwise the conversion to the internal file format (*.xnz) will be wrong.

Field	Option	Description
	GPSeismic LZO	Leica exclusion zone format by GPSeismic software.
	Survey job	Leica database
Exclusion zone file	Selectable list	Available for File type: ESRI SHP and File type: GPSeismic LZO . The file that contains exclusion zones against which the measured or selected preplot position will be tested. The file must be stored in the DATA\ZONE directory on the data storage device. Open the selectable list to change the memory device as needed. Select <None> if no file is available for a given project area. Refer to "Exclusion Zone Files - SHP".
Exclusion zone job	Selectable list	Available for File type: Survey job . Job that contains areas to be loaded as exclusion zones against which the measured or selected preplot position will be tested. The selected job must have the same coordinate system as the current working job.
No. of zones	Display only	Number of exclusion zones included in the selected job. This number does not take account of multi-parts polygon child zones (for shapefile).
Description	Display only	File description as read in the file's header.

Exclusion Zone Files - SHP

Time	Date	Size (kB)
<None>		
20131217_Buffers		
Time 17:22:32	Date 17.12.2013	Size (kB) 992 KB
8312axzn		
Time 15:33:26	Date 18.03.2013	Size (kB) 605 KB
Exclusion_8311		
Time 10:12:36	Date 24.01.2013	Size (kB) 1073 KB
Infra8312		
Time 15:33:26	Date 18.03.2013	Size (kB) 605 KB
MontZoneLamb		
Time 15:55:24	Date 09.04.2013	Size (kB) 32 KB

Key	Description
OK	To accept the selection.
Copy	To copy the selected file to the internal memory.
SD card, USB or Internal	To change between the data storage devices and the internal memory.  The CS35 has two USB ports. The USB stick, that was inserted first, is used.

Exclusion zone viewer

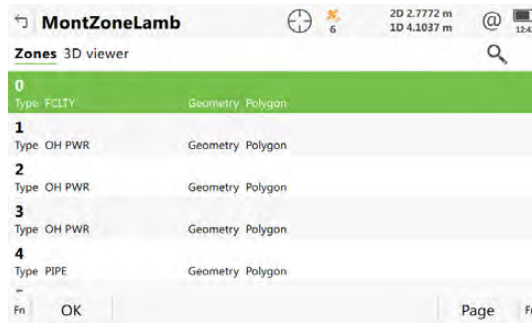

Key	Description
OK	To return to the previous panel.

Define Line Settings

Seismic stakeout is usually done following a line of preplot points. The app can take advantage of line settings definitions to improve the Seismic stakeout.

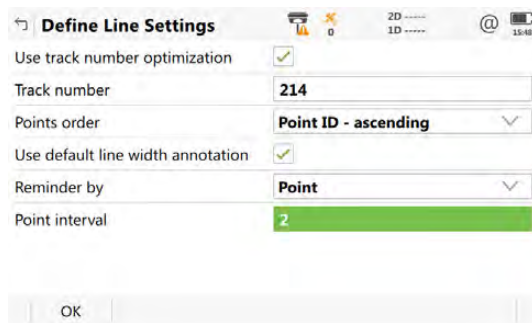

Key	Description
OK	To open the Seismic Stakeout panel.

Description of fields

Field	Option	Description
Use track number optimization	Check box	The track(line) number can be used internally by the app to filter preplot points that belong to the current line being staked. Enabling this option allows the app to automatically create the reference line needed for the To line (cntrl job) navigation direction. Refer to "28.2 Screen, audio & text input". The option also increase the performance of the preplot point test by reducing the number of exclusion zones loaded into memory.
Track number	Editable field	Track number of the line being staked. Common prefix identifier of all preplot points that belong to a given line.
Points order	Selectable list	Line walking direction as defined by preplot point IDs.

Field	Option	Description
Use default line width annotation	Check box	This option is for users who need to report the width of the cut line. It allows to store automatically the last entered line width in the staked point Annotation 4. Depending on the reminder method, a dialog will show-up after point store that recall the user to measure and update the line width value.
Reminder by		Reminder method for line width annotation update.
	Point	Reminds after a point interval
	Distance	Reminds after a distance interval
Point interval	Editable field	Number of staked point after which the default line width annotation must be updated.
Distance interval	Editable field	The distance after which the default line width annotation must be updated.

52.3

Configuring Stakeout

Access

Select **Leica Captivate - Home: Seismic stakeout**. Press **Fn Settings**.

Settings, Exclusion zone page

For all other pages on this panel, refer to "51.3 Configuring Stakeout".

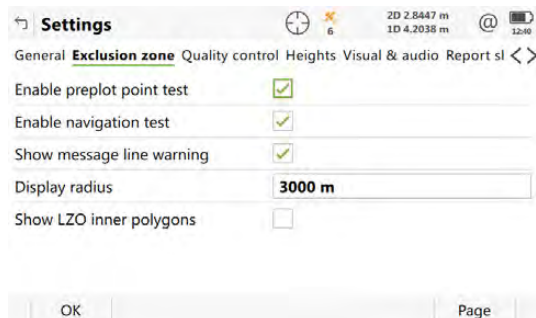

Key	Description
OK	To accept changes and return to the panel from where this panel was accessed.
Page	To change to another page on this panel.
Fn About	To display information about the program name, the version number, the date of the version, the copyright and the article number.

Description of fields

Field	Option	Description
Enable pre-plot point test	Check box	The preplot point test is done each time the current point ID selection changes in the Seismic Stakeout panel. The preplot point position is tested against exclusion zones and an appropriate warning message appears when the position is inside one or more zones.

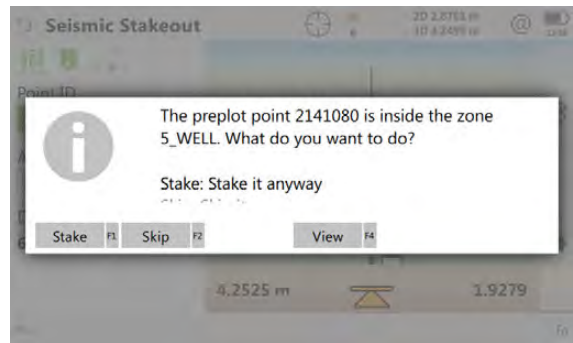
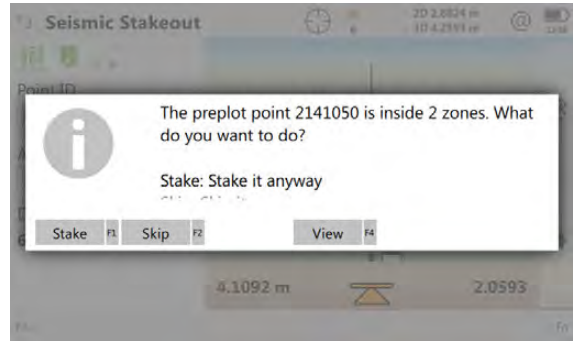





Enable navigation test	Check box	The navigation test is done continuously on the current measured position. The current position is tested against all exclusion zones in the surrounding area as defined by Display radius .
-------------------------------	-----------	---

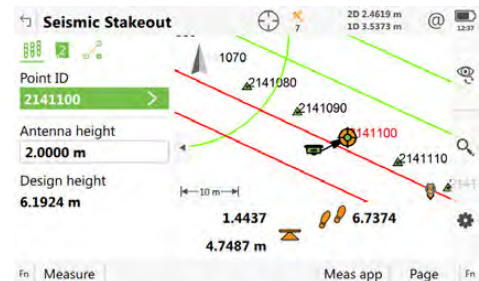

Appears in 3D viewer when the measured position falls inside one or more exclusion zones.

In addition, the touched zone is highlighted in red in the 3D viewer (that could be more than one zone).

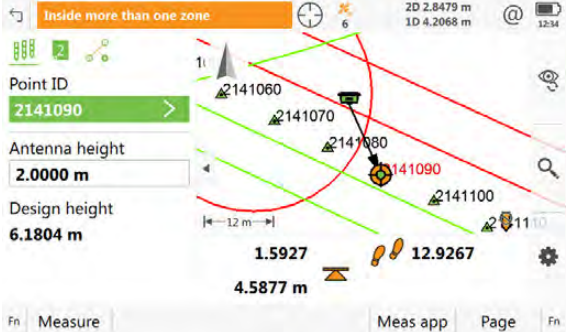
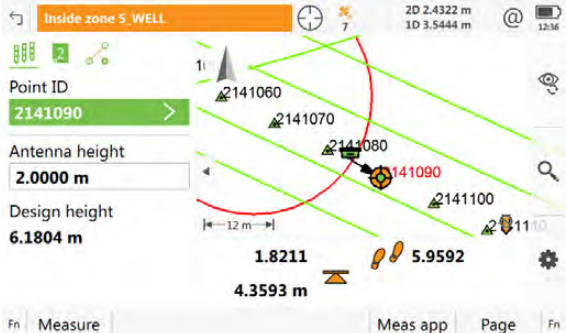



Field	Option	Description
		 <p>Appears 3D viewer when an exclusion zone file is active and the navigation test is disabled.</p>
Show message line warning	Check box	<p>Inside zone warning displayed at the message line when the current measured position falls inside one or more exclusion zones. The message line stays on for a few seconds when triggered even if the user gets out of the zone(s).</p>  
Display radius	Editable field	<p>This radius defines the area around the current measured position for which the exclusion zones will be added to the Seismic Stakeout panel.</p> <p> It is better to keep this value as small as possible to not load too many exclusion zones in memory. The app automatically readjusts this radius when more than 300 zones overlap the defined area</p>
Show LZO inner polygons	Check box	<p>An inner polygon is created when adding an offset to an exclusion zone in GPSeismic (LZO format). Use this option to display inner polygons on the Seismic Stakeout panel. Inner polygons are displayed in yellow and no inclusion test is done against them.</p>

Seismic Stakeout, page

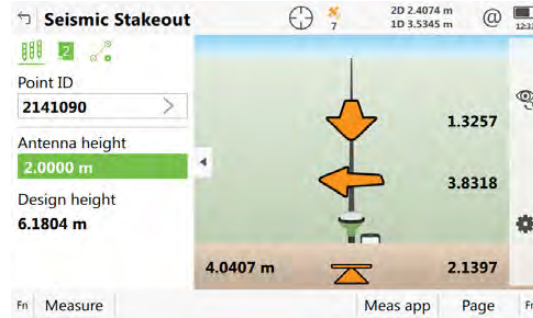
Same as standard Stakeout app, except for specific warning icons that appear in the right bottom corner of the 3D viewer. Refer to "51 Stakeout" for a description of keys, fields and standard elements of the graphical display.



Description of specific elements of the graphical display

Element	Description
	Indicates that current measured position falls inside one or more exclusion zones.
	Indicates that an exclusion zone file is active but navigation test is disabled.

If you try to store a staked point that falls inside one or more exclusion zones, then a warning message appears.

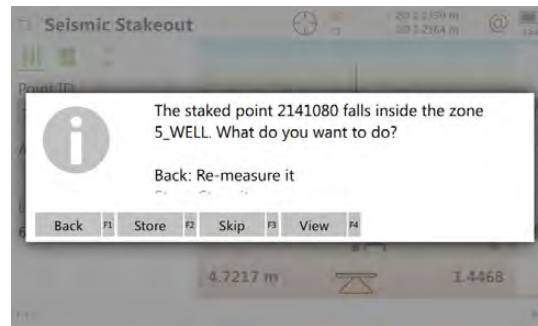

Option	Description
Back	Re-measure the point.
Store	Store the point regardless of the warning. The touched zone(s) name(s) will be automatically stored in the staked point Annotation 2.
Skip	Do not store the point and skip to next preplot point.
View	View touched zone(s).

Seismic Stakeout, page

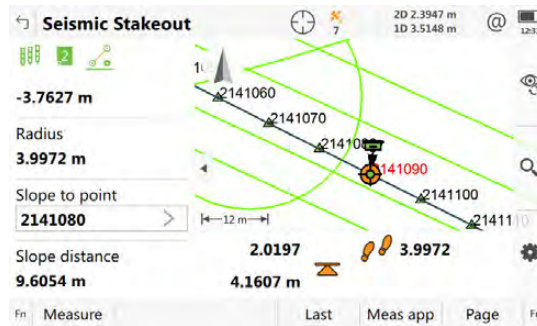
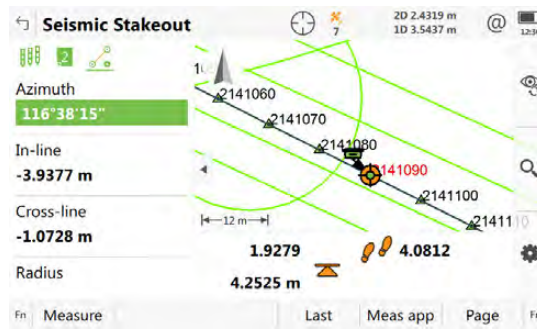

Refer to "51.4 Staking Out" for a description of the standard keys.

Key	Description
Last	To set the Slope to point to the last staked point.

Description of fields

Field	Option	Description
Azimuth	Editable field	<p>Direction from the current preplot point for which the In-line and Cross-line offsets are computed.</p> <p>This azimuth value is automatically updated each time the selected preplot point changes in the 3D viewer.</p> <p>If the Use track number optimization is checked in the Define Line Settings panel, then the computed azimuth is the one from the first to the last point of the track.</p> <p>If the Use track number optimization is not checked in the Define Line Settings panel, then the computed azimuth is based on the next preplot point in the list. If no next point is available, then the azimuth is from the previous point to current one.</p> <p>For specific validation, enter an azimuth value.</p>
In-line	Display only	Measured position in/out offset based on the line from the current preplot point to the given azimuth direction. Negative value is in.

Field	Option	Description
Cross-line	Display only	Measured position left/right offset based on the line from the current preplot point to the given azimuth direction. Negative value is left.
Radius	Display only	Horizontal distance from the measured position to the current preplot point.
Slope to point	Selectable list	Point stored in the working job for which the slope distance from the current measured position is required. Useful when offsetting a preplot point to validate cable length from previous staked point.
Slope distance	Display only	Slope distance from measured position to selected Slope to point .

Description

In this option, a known point stored in the job is used to set up the RTK base.

Access

Select **Leica Captivate - Base: Base setup\Over known point**.

**Over Known Point
Enter the antenna
height & select base
antenna**

Type in the antenna height and select the antenna being used.

Key	Description
Back	To return to the previous panel.
Next	To confirm the settings and to continue to the next panel.

Description of fields

Field	Option	Description
Antenna height	Editable field	The height of the antenna that is being used.
Base antenna	Selectable list	Leica Geosystems antennas are predefined as default and can be selected from the list. Default antennas contain an elevation-dependent correction model. New antenna correction models can be set up and transferred to the instrument using Infinity. Open the list to define or edit antennas. Refer to "23.2.2 Antennas" for information on antennas.
Vertical offset	Display only	The vertical offset of the measurement reference point.

Next step

Next to access **Select point over which base is setup**.

**Select point over
which base is setup**

Select the point to be used as base station.

 A point could already be stored in the design job either by manual entry, by measuring or by transfer from Infinity.

 To create a point, open the selectable list for **Point ID** and press **New**.

 To edit a point, open the selectable list for **Point ID** and press **Edit**.

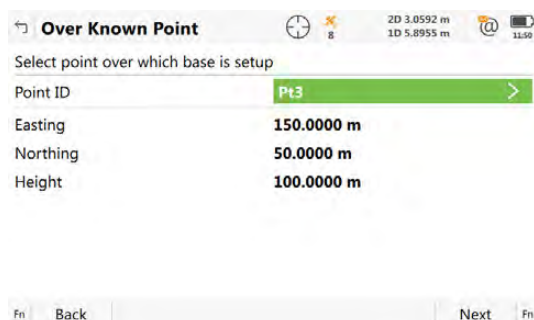

Key	Description
Next	To accept changes and access the subsequent panel.
Coord	To view other coordinate types. Local coordinates are available when a local coordinate system is active.
Back	To return to the previous panel.

Next step

Next to access **Base setup complete..** Follow the instructions on the panel.

53.2

Over last setup

Description

To use the same coordinates as when the instrument was last used as a base.

Availability:

The instrument has been used as base before. No point in the design job has the same point ID as the last used point.

After turning off, the base coordinates are stored in the System RAM. They can be used again the next time the instrument is used as a base. This functionality means that even if the data storage device that previously contained the base coordinates is formatted, the last used coordinates can still be used.

Access

Select **Leica Captivate - Base: Base setup\Over last setup**.

Over Last Setup

This panel is identical with the one in **Over known point**. Refer to "53.1 Over known point".

Next step

Next to access **Last used base point**.

Last used base point

The point ID and coordinates of the last used base are displayed in grid. When no local coordinate system is active, WGS 1984 coordinates are displayed. Refer to "53.1 Over known point" for information on the keys.

Next step

Next to access **Base setup complete..** Follow the instructions on the panel.

53.3

Over any point

Description

To use the coordinates of the current navigation position as base coordinates.

Access

Select **Leica Captivate - Base: Base setup\Over any point.**

Over Any Point

This panel is identical with the one in **Over known point.** Refer to "53.1 Over known point".

Next step

Next to access **Enter point ID & press 'Next' when ready to measure point.**

Enter point ID & press 'Next' when ready to measure point

Type in a point ID for this new point. Refer to 53.1 Over known point for information on the keys.

Code information or annotations can be added in the rover menu.

Next step

Next to access **Base setup complete..** Follow the instructions on the panel.

Requirements

A typical working style for a static or post-processed kinematic operation is used. Ensure that the working style has **GNSS Raw Data Logging** selected in the **GNSS Raw Data Logging** panel.



For information on camera and images refer to "32 Camera & Imaging".

Access

For RTK rover:

Select **Leica Captivate - Home: Measure**.



If configured for post-processed kinematic operations, the logging of moving observations begins.

Measure

The fields shown are from a typical working style for static or post-processed kinematic operations. The panel described consists of four pages. The explanations for the softkeys given here are valid for the  page and the two user-defined pages. Refer to "35 3D viewer" for information on the keys in 3D viewer.

The fields and functionality of this panel vary slightly when accessed from other apps where individual point measurements are needed.

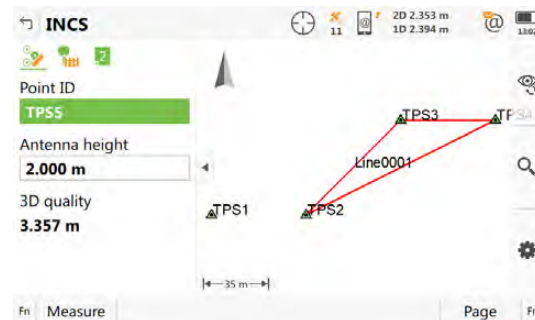

Key	Description
Measure	To start logging of static observations. The key changes to Stop .
Stop	To end recording of positions when enough data is collected. When Automatically stop point measurement is checked in GS Quality Control, General page, recording of positions ends automatically as defined by the stop criteria. The key changes to Store .
Store	To store the point information. When Automatically store point is checked in GS Quality Control, General page, the measured point is stored automatically. The key changes to Measure .

Key	Description
Near	To compare the current position with the coordinates of all points already stored in the job and find the nearest point. This point ID is then suggested as the next point ID to be used.
Page	To change to another page on this panel.
Fn Settings	To configure the pages displayed and auto point measurements.
Fn Display	To configure what is displayed in the 3D viewer.
Fn Tools	Refer to "37 Apps - The Toolbox".

Description of fields

Field	Option	Description
Point ID	Editable field	The identifier for manually measured points. The configured point ID template is used. The ID can be changed in the following ways: <ul style="list-style-type: none"> To start a new sequence of point IDs type over the point ID. For an individual number independent of the ID template Fn Tools.
Antenna height	Editable field	The antenna height as defined in the active working style is suggested. Changes in the antenna height do not update the antenna height as defined in the active working style. The changed antenna height is used until the app is exited.
3D quality	Display only	The current 3D coordinate quality of the computed position.

54.1.2

Real-Time Rover Operations

Requirements

- A typical working style for real-time rover operations is used.
- The appropriate real-time device is attached and working properly.



For information on camera and images refer to "32 Camera & Imaging".

Access

For RTK rover:

Select **Leica Captivate - Home: Measure**.

Measure

The fields shown are from a typical working style for real-time rover operations. The panel described consists of four pages. The explanations for the softkeys given here are valid for the  page and the two user-defined pages. Refer to "35 3D viewer" for information on the keys in 3D viewer.

The fields and functionality of this panel vary slightly when accessed from other apps where individual point measurements are needed.

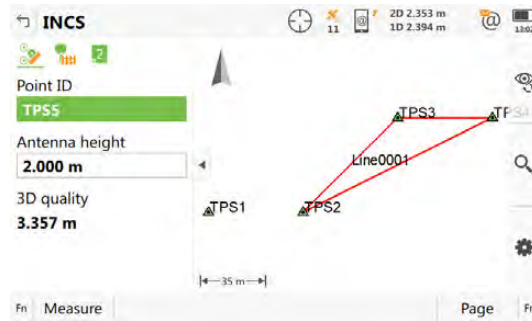

Key	Description
Measure	To start logging of static observations. The key changes to Stop .
Stop	To end recording of positions when enough data is collected. When Automatically stop point measurement is checked in GS Quality Control, General page, recording of positions ends automatically as defined by the stop criteria. The key changes to Store .
Store	To store the point information. When Automatically store point is checked in GS Quality Control, General page, the measured point is stored automatically. The key changes to Measure .
Near	To compare the current position with the coordinates of all points already stored in the job and find the nearest point. This point ID is then suggested as the next point ID to be used.
Page	To change to another page on this panel.
Fn Settings	To configure the pages displayed and auto point measurements.
Fn Display	To configure what is displayed in the 3D viewer.
Fn Connect and Fn Disconnect	To connect/disconnect from the reference data.
Fn Tools	Refer to "37 Apps - The Toolbox".

Description of fields

Field	Option	Description
Point ID	Editable field	The identifier for manually measured points. The configured point ID template is used. The ID can be changed in the following ways: <ul style="list-style-type: none"> To start a new sequence of point IDs type over the point ID. For an individual number independent of the ID template Fn Tools.

Field	Option	Description
Antenna height	Editable field	The antenna height as defined in the active working style is suggested. Changes in the antenna height do not update the antenna height as defined in the active working style. The changed antenna height is used until the app is exited.
3D quality	Display only	The current 3D coordinate quality of the computed position.

54.2

Adding Annotations

Description

Annotations can be used to add either field notes or comments to points being surveyed.

Access

For RTK rover:

Select **Leica Captivate - Home: Measure**. Go to the **Page 3** page.



If it is not already displayed, the **Page 3** page can be configured to appear in the Measure app through the **User Defined Pages** panel. Refer to "26.2 User defined pages" for more information.

Connect

Description of fields

Field	Option	Description
Annotation 1 to Annotation 4	Editable field	Type in the annotation. The annotation can be up to 16 characters long and can include spaces.
		When the ASCII input interface is configured and an annotation is reserved for the incoming ASCII string, then no other information can be typed in.
		ESC to clear the entry.
		Last to recall all annotations entered for the previously surveyed point. Any annotations entered are overwritten.
		ENTER . The next line is highlighted.

Next step

1. **Measure** to start the point measurement.
2. **Stop** to end the point measurement.
3. **Store** to store the point information including the annotations.

Description

Surveying regulations in some countries require that several instruments in a session start the point measurement simultaneously at a predefined time. Timed measurements are possible for all types of GS operations, except for real-time base operations.

Requirements

- **Automatically start measuring point on entering the Measure app: Timed** is configured in **GS Quality Control, Advanced** page. Refer to "25.3 GS quality control".
- **Time at point** is configured for one of the lines in one of the pages. Refer to "26.2 User defined pages".

Access

For RTK rover:

Select **Leica Captivate - Home: Measure**.

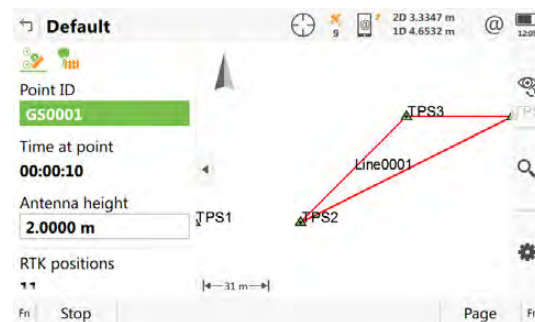
Connect**Description of fields**

Field	Option	Description
Start time	Editable field	The current local time with the seconds rounded to 00, for example for the current local time 07:37:12 it is 07:38:00. Type in the start time in hours, minutes and seconds for when the point measurement begins. Press Measure . The point measurement does not start yet. The name of the field changes to Time to go .
Time to go	Display only	The countdown time in hours, minutes and seconds before the point measurement starts automatically. The point measurement starts when it is 00:00:00. Then, data is logged as configured in the working style. Any measurement counter-defined to be used in a page is displayed and starts incrementing. The name of the field changes to Time at point .

Field	Option	Description
Time at point	Display only	The time in hours, minutes and seconds from when the point is measured until point measurement is stopped. Press Stop and Store when enough data is collected. The name of the field changes to Start time .

Description

The Survey app is used for point measurement. Angles and distances for points can be measured and the calculated coordinates stored using **Measure**, **Distance** and **Store**.



For information on camera and images refer to "32 Camera & Imaging".

Access

Select **Leica Captivate - Home: Measure**.

**Leica Captivate -
Home,
page**

The fields shown are from a typical working style. The panel described consists of four pages.

The fields and functionality of this panel vary slightly when accessed from other apps where individual point measurements are needed.



Key	Description
Measure	To measure and store distances and angles.
Stop	Available if Measure distance: Continuously and Distance was pressed. Stops the distance measurements. The key changes back to Measure .
Distance	To measure and display distances.
Store	To record data. If Measure distance: Continuously and/or Automatically measure points is checked, records measured point and continues tracking.
Page	To change to another page on this panel.
Fn Settings	To configure the pages displayed and auto point measurements.
Fn Display	To configure what is displayed in the 3D viewer.
Fn Tools	Refer to "37 Apps - The Toolbox".

Description of fields

Field	Option	Description
Point ID	Editable field	The identifier for measured points. The configured point ID template is used. The ID can be changed: <ul style="list-style-type: none"> To start a new sequence of point IDs overtype the point ID. For an individual number independent of the ID template Fn Tools.
Target height	Editable field	The last used target height is suggested when accessing the Measure app. An individual target height can be typed in.
Hz	Display only	The current horizontal angle.
V	Display only	The current vertical angle.
Horizontal distance	Display only	The horizontal distance after Distance was pressed. No distance is displayed when accessing the panel and after Store or Measure .
Difference in height	Display only	The height difference between setup and measured point after Distance . Displays ----- when accessing the panel and after Store or Measure .
Easting	Display only	Easting coordinate of the measured point.
Northing	Display only	Northing coordinate of the measured point.
Height	Display only	Elevation of the measured point.

56.1

Overview

Description

Auto points are used to log points automatically at a specified rate. Additionally, individual auto points can be stored outside the defined rate.

Auto points can be collected in the Measure app. A  page is visible when logging of auto points is active.

Auto points are used in moving applications to document a track which was walked or driven along. Auto points that are logged between starting and stopping logging of auto points form one chain. A new chain is formed each time logging of auto points is started.

Up to two offset points related to one auto point can be logged. The offset points can be both to the left or right and they can be coded independently of each other and of the auto points.



Logging of auto points is possible for both TS and GS.

Coding of auto points

Coding of auto points is similar to coding manually occupied points. Refer to "27 Coding" for information on coding.

The differences are:

Type	Description
Point coding	Always available. Without linework.
Free coding	Always available. Same as for manually measured points.
Quick coding	Not available.

Codes of auto points overwrite the codes of points with the same point ID but a different code, existing in the job.

Codes of auto points can be changed when no auto points are being logged. Up to eight attributes can be stored with a code.

Averaging of auto points

An average is never calculated for auto points even if a manually occupied point of class **Measured** already exists with the same point ID.

56.2

Configuring Auto Points

Access

Select **Leica Captivate - Home: Measure**.
Press **Fn Settings**.

Measure Settings,
Automatically measure
pts page

Measure Settings

Add page tabs **Automatically measure pts**

Automatically measure points



Measure new point after certain **Distance**

Measure point every **2.300 m**

OK Content Page

Key	Description
OK	To accept changes and return to the panel from where this panel was accessed.
Content	To configure what is viewed in the  page in the Measure app. Available for Automatically measure points checked.
Page	To change to another page on this panel.

Description of fields

Field	Option	Description
Automatically measure points	Check box	Activates the logging of auto points.  All other fields on the panel are active and can be edited.
Measure new point after certain	Time	Auto points are logged according to a time interval. The time interval is independent from the update interval for the position on the panel.
	Distance	The difference in distance from the last stored auto point, which must be reached before the next auto point is logged. The auto point is logged with the next available computed position.
	Difference in height	The height difference from the last stored auto point, which must be reached before the next auto point is logged. The auto point is logged with the next available computed position.
	Distance or height	Before the next auto point is logged, either the difference in distance or the difference in height must be reached. The auto point is logged with the next available computed position.
	Distance & time	An auto point is stored when the position of the antenna/prism does not move more than the distance configured in Minimum distance between points within the Stop time . Once a point has been stored, the position must change more than the distance configured in Minimum distance between points before the routine starts again.
	Key press	An auto point is stored upon pressing Measure (for GS) / Store (for TS) in the Measure app,  page. In the beginning, the chain to which the auto points are assigned must be started with Start . In the end, the chain must be closed with Stop .

Field	Option	Description
Measure point every		Available unless Measure new point after certain: Distance or height , Measure new point after certain: Distance & time or Measure new point after certain: Key press .
	Editable field	For Measure new point after certain: Distance and Measure new point after certain: Difference in height . The difference in distance or height before the next auto point is logged.
	From 0.1 sec to 60.0 sec	For Measure new point after certain: Time . The time interval before the next auto point is logged. For GS08plus logging rates of 0.2 s and slower are supported.
When distance changed by	Editable field	Available for Measure new point after certain: Distance or height . The value for the difference in distance before the next auto point is logged.
Or when height changed by	Editable field	Available for Measure new point after certain: Distance or height . The value for the height difference before the next auto point is logged.
Minimum distance between points	Editable field	Available for Measure new point after certain: Distance & time . The distance within which the position is considered stationary.
Stop time	Editable field	Available for Measure new point after certain: Distance & time . The time while the position must be stationary until an auto point is stored.
Store points		Available for GS.  Changing this setting while auto points are being logged stops the logging. It must then be restarted.
	To MDB (pts only)	Logs auto point to a job file. Point logging at up to 20 Hz. Coding and logging of offset points is not possible. Points cannot be displayed in 3D viewer or output using format files.
	To DBX (pts&codes)	Logs auto points to the DBX. Point logging at up to 1 Hz. Coding and logging of offset points is possible. Points can be displayed in 3D viewer or output using format files.
Logging starts when		Available for GS.
	Accessing the Measure app	Logging of auto points starts immediately when the Measure app is accessed.

Field	Option	Description
	Press 'Start' in Measure app	Logging of auto points starts upon pressing Start on the  page in the Measure app.
Do not store point if 3D CQ exceeds limit	Check box	Available for GS. If checked, monitoring of the coordinate quality is activated. Auto points are stored when the coordinate quality is within the defined limit. For example, only phase fixed solutions can be logged by defining a CQ limit.
3D quality limit	Editable field	Available for GS if Do not store point if 3D CQ exceeds limit is checked. Limit for the coordinate quality above which an auto point is no longer automatically stored. When the CQ of the auto point falls again below the defined value then the storing of auto points begins again.
Beep when		Available for GS.
	Point is stored	Instrument beeps when storing an auto point.
	3D quality is exceeded	Instrument beeps when auto points are not stored.
	Never	Instrument never beeps.

Next step

IF the page content	THEN
is not to be configured	OK closes the panel and returns to the previous panel.
is to be configured	Content.

Auto Points Page Content



Page Settings 1

Name: Measure

1st line: Point ID

2nd line: Code

3rd line: Target height

4th line: Separator

5th line: Hz angle

6th line: V angle

7th line: Horizontal distance

Fn OK Clear Fn

Key	Description
OK	To accept changes and to return to previous panel.
Clear	To set all fields to Unused line .
Fn Default	To recall the default settings.

Description of fields

Field	Option	Description
1st line	Display only	Fixed to Point ID .
2nd line to 16th line		For each line, one of the following options can be selected.
	Angle right	For TS: Displays the horizontal angle difference between the backsight point and the current telescope position.
	% completed	For GS: Display only field for the percentage of the time for which the point has been occupied based on the setting for Stop measurement based on in the GS Quality Control panel. Appears in the page during the point occupation if Automatically stop point measurement is checked.
	Annotation 1 to Annotation 4	Editable field for comments to be stored with the point.
	Antenna height	For GS: Editable field for antenna height for static observations.
	Attribute (free) 01 to Attribute (free) 20	Display only field for attributes for free codes.
	Attribute 01 to Attribute 20	Editable field for attributes for codes.
	Azimuth	For TS: Display only field for the azimuth.
	Code	Editable field for codes.
	Code (free)	Editable field for free codes.
	Code description (free)	Display only field for the description of free codes.
	Code description	Display only field for the description of codes.
	Easting	For TS: Display only field for Easting coordinate of measured point.
	GDOP	For GS: Display only field for the current GDOP of the computed position.
	HDOP	For GS: Display only field for the current HDOP of the computed position.

Field	Option	Description
	Height	For TS: Display only field for the height coordinate of the measured point.
	Difference in height	For TS: Display only field for the height difference between setup and reflector.
	Horizontal distance	For TS: Display only field for horizontal distance.
	Humidity	For GS: Editable field for relative humidity to be stored with point.
	Hz angle	For TS: Display only field for the horizontal angle.
	Local ellipsoid height	For GS: Display only field for the elevation of the current GNSS position.
	Moving antenna height	For GS: Editable field for antenna height for moving observations.
	Logged raw data counter	For GS: Display only field for the number of static observations recorded over the period of point occupation. Appears in the page when recording of static observations is configured.
	Northing	For TS: Display only field for Northing coordinate of measured point.
	Offset height	For TS: Editable field for height offset for measured point.
	Offset in/out	For TS: Editable field for horizontal distance offset, in the direction of line of sight.
	Offset left/right	For TS: Editable field for horizontal distance offset for measured point, perpendicular to the line of sight.
	Offset mode	For TS: Select offset mode.
	PDOP	For GS: Display only field for the current PDOP of the computed position.
	PPM total	For TS: Display only field for the total ppm value.
	Point ID	Editable field for the point ID.
	Pressure	For GS: Editable field for atmospheric pressure.

Field	Option	Description
	Prism constant	For TS: Display only field for additive constant of currently selected reflector.
	1D quality	Display only field for the current height coordinate quality of computed position.
	2D quality	Display only field for the current 2D coordinate quality of computed position.
	3D quality	Display only field for the current 3D coordinate quality of computed position.
	RTK positions	For GS: Display only field for the number of positions recorded over the period of point occupation. Appears in the page of real-time rover settings.
	Slope distance (last stored)	For TS: Display only field for the last recorded distance.
	Separator	Insert half line space.
	Slope distance	For TS: Display only field for measured slope distance.
	Standard deviation	For TS: Display only field of standard deviation in millimetres of averaged distances.
	Target height	For TS: Editable field for prism height.
	Unused line	Insert full line space.
	Temperature (dry)	For GS: Editable field for dry temperature to be stored with point.
	Temperature (wet)	For GS: Editable field for wet temperature to be stored with point.
	Time at point	For GS: Display only field for the time from when the point is occupied until point occupation is stopped. Appears in the page during the point occupation.
	V angle	For TS: Display or select vertical angle.
	VDOP	For GS: Display only field for the current VDOP of the computed position.
	WGS84 ellipsoid height	For GS: Display only field for the current GNSS position.
	WGS84 latitude	For GS: Display only field for the current GNSS position.

Field	Option	Description
	WGS84 longitude	For GS: Display only field for the current GNSS position.

56.3

Measuring Auto Points

Requirements

- **Automatically measure points** in **Measure Settings, Automatically measure points** page.
- For GS: The rover menu must be used.

Access

Select **Leica Captivate - Home: Measure**.
Go to the  page.

Measure

Before logging of auto points has started, the page appears as shown:



Key	Description
Start	<ul style="list-style-type: none"> • To start logging of auto points. • To start logging of offset points, if configured. • For Logging starts when: Press 'Start' in Measure app: To start the chain to which the auto points are assigned. The first auto point is stored. • For Logging starts when: Accessing the Measure app: Logging of auto points starts immediately when the Measure app is accessed. Start need not be pressed. • For TS: <ul style="list-style-type: none"> • Measure distance: Continuously becomes active. • For Measure: Prism instrument locks onto prism. • For Measure distance: Greater than 4km, Measure: Prism is set and instrument locks onto the prism.
Stop	<ul style="list-style-type: none"> • To end recording of auto points. • To end recording offset points, if configured. • For Measure new point after certain: Key press: To end the chain to which the auto points are assigned.
Measure	Available for GS. To store a point at any time.
Store	Available for TS. To store a point at any time.

Key	Description
Offset 1	Available when Store points: To DBX (pts&codes) in Measure Settings, Automatically measure pts page. To configure recording of the first type of offset points. Refer to "56.4.2 Configuring Offset Points".
Offset 2	Available when Store points: To DBX (pts&codes) in Measure Settings, Automatically measure pts page. To configure recording of a second type of offset points. Refer to "56.4.2 Configuring Offset Points".
Page	To change to another page on this panel.
Fn Settings	To configure auto points. Refer to "56.2 Configuring Auto Points".
Fn Display	To configure what is displayed in the 3D viewer.

Description of fields for the default settings

Field	Option	Description
Auto point ID	Editable field	Available unless GS auto points: Date & time/TS auto points: Date & time in ID Templates . The identifier for auto points. The configured ID template for auto points is used. The ID can be changed. To start a new sequence of point IDs, type over the point ID.
	Date & time	Available for GS auto points: Date & time/TS auto points: Date & time in ID Templates . The current local time and date is used as identifier for auto points.
Moving antenna height	Editable field	Available for GS. The antenna height for auto points as defined in the active working style is suggested.
Target height	Editable field	Available for TS. The target height as defined in the active settings is suggested.
Code (auto)		The point code for the auto point. No stringing is possible between automatically measured points, even if the code has the linework functionality assigned. Depending on the setting for Allow new codes to be created in Coding, Code & attributes page, the field is a simple list or a selectable list and an editable field at the same time.
Code description	Display only	The description of the code.
Measured auto points	Display only	Available after pressing Start . The number of auto points logged since Start has been pressed.

Field	Option	Description
3D quality	Display only	Available for GS. The current 3D coordinate quality of the computed position.
Slope distance	Display only	The measured slope distance. When Start is pressed, Measure distance: Continuously is set and the slope distance is constantly updated.
Hz	Display only	The current horizontal angle.
V	Display only	The current vertical angle.

Next step

IF	THEN
auto points are to be logged	Start. Then, for Measure new point after certain: Key press, Measure whenever you want to log an auto point.
offset points are to be configured	Offset 1 or Offset 2. Refer to "56.4 Offset Points of Auto Points".

56.4

Offset Points of Auto Points

56.4.1

Overview

Description

Offset points

- can be created with auto points when auto points are stored to the DBX.
- can be to the left or to the right of auto points.
- are automatically computed with the logging of auto points, if configured.
- form a chain relative to the chain of auto points to which they are related. Subsequent computed chains are independent from each other.
- can be coded independently of auto points.
- have the same time of when they were stored as the auto points to which they are related.
- have the same coding functionality, properties and averaging functionality as auto points.

Up to two offset points can be related to one auto point.

The panels for the settings of offset points are identical except for the title **Auto Points - Offset 1** and **Auto Points - Offset 2**. For simplicity, the title **Auto Points - Offset 1** is used in the following description.

Computation of offset points

The computation of offset points depends on the number of auto points in one chain.

One auto point

No offset points are computed or stored.

Two auto points

The configured offsets are applied perpendicular to the line between two auto points.

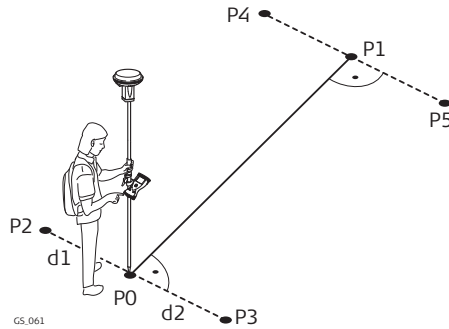

For GS:

- P0 First auto point
- P1 Second auto point
- P2 First offset point for P0
- P3 Second offset point for P0
- P4 First offset point for P1
- P5 Second offset point for P1
- d1 Horizontal offset to the left
- d2 Horizontal offset to the right

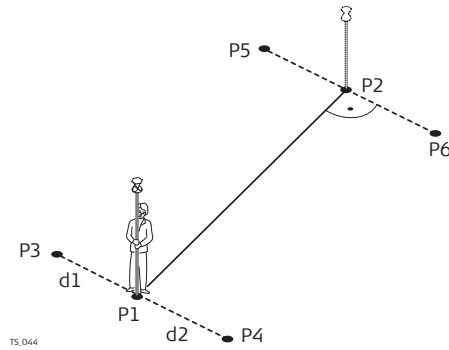

For TS:

- P1 First auto point
- P2 Second auto point
- P3 First offset point for P1
- P4 Second offset point for P1
- P5 First offset point for P2
- P6 Second offset point for P2
- d1 Horizontal offset to the left
- d2 Horizontal offset to the right

Three or more auto points

The first offset points are computed perpendicular to the line between the first and the second auto point.

The last offset point is computed perpendicular to the line between the last auto point and the one before.

All other offset points are computed on a bearing. The bearing is half of the angle between the last and the next measured auto point.

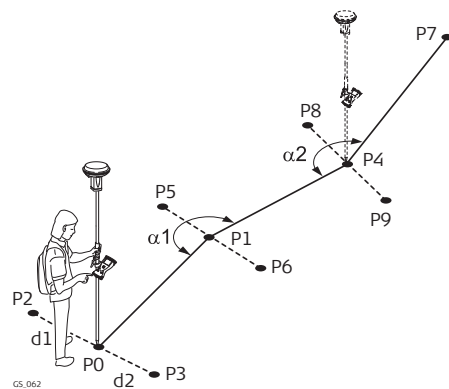

For GS:

- P0 First auto point
- P1 Second auto point
- P2 First offset point for P0
- P3 Second offset point for P0
- P4 Third auto point
- P5 First offset point for P1
- P6 Second offset point for P1
- P7 Fourth auto point
- P8 First offset point for P4
- P9 Second offset point for P4
- d1 Horizontal offset to the left
- d2 Horizontal offset to the right
- α_1 Angle between P0 and P4
- α_2 Angle between P1 and P7

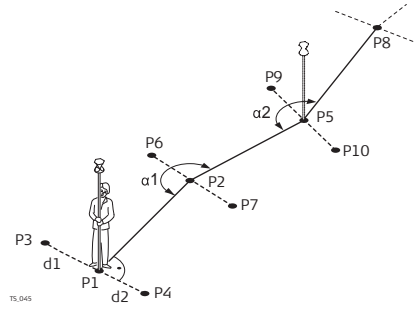

For TS:

- P1 First auto point
- P2 Second auto point
- P3 First offset point for P1
- P4 Second offset point for P1
- P5 Third auto point
- P6 First offset point for P2
- P7 Second offset point for P2
- P8 Fourth auto point
- P9 First offset point for P5
- P10 Second offset point for P5
- d1 Horizontal offset to the left
- d2 Horizontal offset to the right
- α_1 Angle between P1 and P5
- α_2 Angle between P2 and P8

56.4.2

Configuring Offset Points

Requirements

For GS, configure **Store points: To DBX (pts&codes)** in **Measure Settings, Automatically measure pts** page.

Access

Press **Offset 1** or **Offset 2** in the **Measure** on the page.

Auto Points - Offset 1, General page

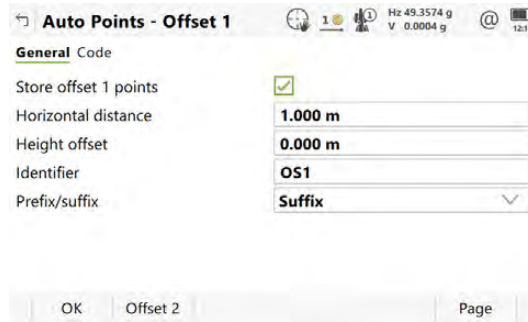

Key	Description
OK	To accept changes and return to the panel from where this panel was accessed.
Offset 2 and Offset 1	To switch between configuring offset point type one and two.
Page	To change to another page on this panel.

Description of fields

Field	Option	Description
Store offset 1 points and Store offset 2 points	Check box	Activates logging of offset points. All other fields on the panel are active and can be edited with this setting.
Horizontal distance	Editable field	The horizontal offset between -1000 m and 1000 m at which the offset point is collected.

Field	Option	Description
Height off-set	Editable field	The height offset between -100 m and 100 m from the related auto point.
Identifier	Editable field	The identifier with up to four characters is added in front of or at the end of the ID of the auto point. This ID is then used as the point ID for the related offset point. This functionality could support an automatic workflow into CAD packages including setting symbols and stringing lines.
Prefix/suffix	Prefix	Adds the setting for Identifier in front of the auto point ID.
	Suffix	Adds the setting for Identifier at the end of the auto point ID.

Next step

Page changes to the **Code** page.

Auto Points - Offset 1, Code page

Key	Description
OK	To accept changes and return to the panel from where this panel was accessed.
New attrb	To create more attributes for the selected code.
Last	To recall the last used attribute values for the selected code.
Default	To recall the default attribute values for the selected code.
Page	To change to another page on this panel.

Description of fields

Field	Option	Description
Code	Selectable list	The code for the offset point. The attributes are shown as display only, editable field or selectable list depending on their definition.
Attributes	Editable field	Up to eight attribute values can be stored.

Next step

IF	THEN
offset point configuration is finished	OK to return to the Measure panel.
a second offset point is to be configured	Page and then Offset 2 or Offset 1 to change to the settings panel for the second point.

Example for offset point IDs

The offset point ID is a combination of the auto point ID and an identifier as a prefix or suffix.

The right most part of the auto point ID is incremented within the point ID. If the length of the auto point ID plus identifier is greater than 16 characters, then the auto point ID is truncated from the left.

Auto point ID	Identifier	Prefix/Suffix	Offset point ID
Auto1234 Auto1235	OS1	Prefix	OS1Auto1234 OS1Auto1235...
Auto1234 Auto1235	OS1	Suffix	Auto1234OS1 Auto1235OS1...



Refer to "26.3 **ID templates**" for more information on point IDs.

57

Hidden Point on TS

57.1

Overview

Description

Hidden points cannot be measured directly by a TS instrument, because they are not directly visible.

A hidden point can be calculated from measurements to prisms mounted on a hidden point rod. The spacing and length of the hidden point rod are known. The hidden point rod can be held at any angle, as long as it is stationary for all measurements.

Measurements for the hidden point are calculated as if the hidden point was observed directly. These calculated measurements can also be recorded.

The hidden point rod can have either two or three prisms. If three prisms are used the average will be calculated.

Hidden point rod

The prisms on the hidden point rod are also called auxiliary points after they have been measured.

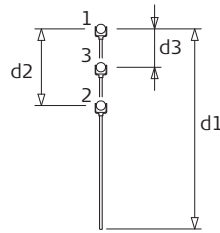

- 1 Prism 1
- 2 Prism 2
- 3 Prism 3
- d1 Rod length
- d2 Distance from prism 1 to prism 2
- d3 Distance from prism 1 to prism 3

Hidden point tasks

The Hidden Point app can be used for the following tasks:

- The hidden point app can be used to obtain accurate three-dimensional coordinates for a point that is blocked from direct measurement by an obstruction.
- Determination of flow line locations and elevations in inspection hatches, without measuring from the rim to the flow line. Estimation corrections for nonverticality of the measuring tape and eccentricity from the rim measurement to the flow line.
- Determination of recesses in building corners for detailed surveys, without estimating right angle offsets, with or without taping of the dimensions.
- Measurements behind overhangs, buttresses and columns for quantity determinations in underground construction or mining, without estimating right angle offsets, with or without taping of the dimensions.
- Measurements of industrial process piping or other equipment in close quarters.
- Detailed architectural surveys for remodelling or cultural preservation or restoration work
- Any place where accurate measurements would require many more instrument setups in order to achieve line of sight from the instrument to the points being measured.



The TS Hidden Point app does not generate a report sheet.

57.2

Accessing Hidden Point and Measuring

Access

Select **Leica Captivate - Home: TS hidden point** menu.



If this app is used for the first time, the **Settings** panel is displayed.

Diagram

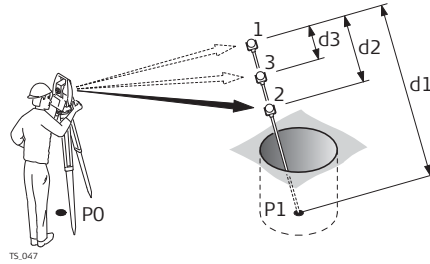

- d1 Rod length
- d2 Distance from prism 1 to prism 2
- d3 Distance from prism 1 to prism 3

Measure Reflector 1, Hidden point page

Measure Reflector 1 Hz 0.0010 g
V 0.0002 g

Measure **Hidden point**

Auxiliary point ID Aux0003

Hz **0.0010 g**

V **0.0002 g**

Slope distance -----

Difference in height -----

Rod length

Fn Measure Distance Store Page Fn

Key	Description
Measure	To measure and store the prism, and access the next panel.
Distance	To measure a distance.
Store	To store data.
Page	To change to another page on this panel.
Fn Settings	To configure the TS hidden point app. Refer to "57.3 Configuring Hidden Point".

Description of fields

Field	Option	Description
Auxiliary point ID	Editable field	The point ID of the auxiliary point, the prism on the hidden point rod. The Auxiliary Points ID template is used.
Hz	Display only	The horizontal angle to prism 1, the auxiliary point, is displayed.
V	Display only	The vertical angle to prism 1, the auxiliary point, is displayed.
Slope distance	Display only	The slope distance to prism 1, the auxiliary point, is displayed.
Difference in height	Display only	The height difference to prism 1, the auxiliary point, is displayed.

Field	Option	Description
Rod length	Editable field	The length of the rod can be adjusted before the hidden point result is displayed. The rod length always keeps the distances R1-R2 for two prisms and R1-R3 for three prisms into account.

Next step

Take the measurements to prism 2 and, if desired, to prism 3. After the last prism of the hidden point rod is measured, **Hidden Point Result, Hidden point result** page is accessed.

Hidden Point Result, Hidden point result page

Field	Value
Point ID	TPSS
Hz	111.1112 g
V	0.0637 g
Slope distance	24.000 m
Difference in height	25.580 m
Easting	1.024 m
Northing	0.996 m

Key	Description
Store	To measure the prism and exit the app.
Next	To store the hidden point and to access Measure Reflector 1 to take more hidden point measurements.
Page	To change to another page on this panel.
Fn Individ ID Fn Run	To change between entering an individual point ID different to the defined ID template and the running point ID according to the ID template. Refer to "26.3 ID templates".

Description of fields

Field	Option	Description
Point ID	Editable field	The name of the hidden point. The configured point ID template is used.
Hz	Display only	The calculated horizontal angle to the computed hidden point. ----- is displayed for unavailable information.
V	Display only	The calculated vertical angle to the computed hidden point. ----- is displayed for unavailable information.
Slope distance	Display only	The calculated slope distance to the computed hidden point. ----- is displayed for unavailable information.
Difference in height	Display only	The calculated height difference from instrument to computed hidden point. ----- is displayed for unavailable information.

Field	Option	Description
Easting, Northing and Height	Display only	The calculated coordinates of the computed hidden point. ----- is displayed for unavailable information.

Next step

Page changes to the **Code** page. Type in a code if desired. In the 3D viewer, solid arrows indicate measured distances.

57.3

Configuring Hidden Point

Access

In **Measure Reflector 1** press **Fn Settings**.

Settings

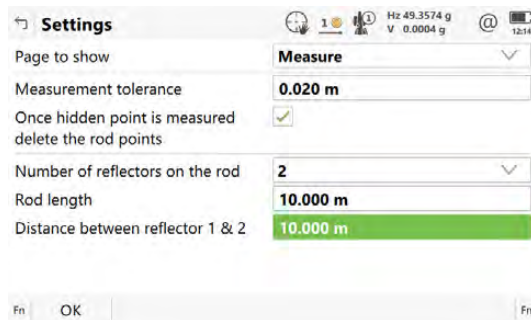

Key	Description
OK	To accept changes and return to the panel from where this panel was accessed.
Edit	To configure the selected page. Refer to "26.2 User defined pages ".
Fn About	To display information about the program name, the version number, the date of the version, the copyright and the article number.

Description of fields

Field	Option	Description
Page to show	Selectable list	The user-defined page to be shown in Measure Reflector 1 , Measure Reflector 2 and Measure Reflector 3 .
Measurement tolerance	Editable field	Limit of the difference between input and measured spacing of the prisms.  For three prisms being used, limit for maximum deviation of the three measurements.
Once hidden point is measured delete the rod points	Check box	The auxiliary points are deleted when the hidden point is stored.

Field	Option	Description
		The auxiliary points are prism 1, prism 2 and prism 3 of the hidden point rod. The Auxiliary Points ID template is used for the auxiliary points. The point ID template is used for the computed hidden point.
Number of reflectors on the rod	2 or 3	Two or three prisms are used on the rod.
Automatically turn instrument to reflector 3	Check box	Available for Number of reflectors on the rod: 3 . The third prism is aimed at automatically.
Rod length	Editable field	Total length of hidden point rod.
Distance between reflector 1 & 2	Editable field	Spacing between the centres of prism 1 and prism 2.
Distance between reflector 1 & 3	Editable field	Available for Number of reflectors on the rod: 3 . Spacing between the centres of prism 1 and prism 3. Prism 3 is situated between prism 1 and prism 2.

Next step

OK returns to the panel from where this panel was accessed from.

58

Traverse

58.1

Overview

Description

The Traverse app is used to fulfil one of the most common operations done by surveyors; to establish a control point base system to be used as a skeleton for other survey operations. For example, topographic survey, point stakeout, line stakeout or road stakeout.



If the message panel appears which requires that the app must be activated using a licence key then refer to "29.3 Load licence keys".

Types of traverse

- External reference & closed loop
- Internal reference & position check
- Open end & position check
- Closed end traverse

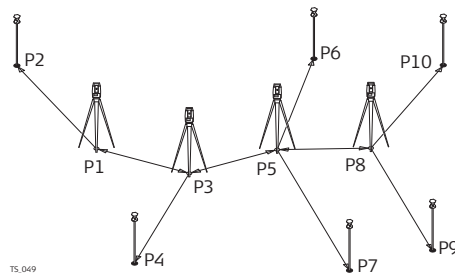

- P1 Traverse point
- P2 Backsight point
- P3 Traverse point
- P4 Sideshot point
- P5 Traverse point
- P6 Sideshot point
- P7 Sideshot point
- P8 Closing point
- P9 Sideshot point
- P10 Closing angle point

58.2

Accessing Traverse

Access

Select **Leica Captivate - Home: Traverse**.



If traverses exist, then the **Traverse** panel opens. If no traverse exists, then the **New Traverse** panel opens.

Traverse

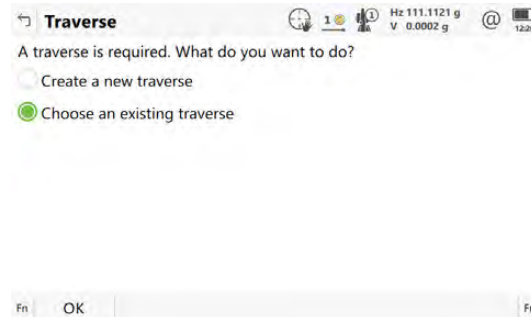

Key	Description
OK	To select the highlighted option and to continue with the subsequent panel.
Fn Settings	To configure the Traverse app. Refer to "58.6 Configuring Traverse".

Next step

IF	THEN
a traverse is to be created or selected	highlight the relevant option and press OK .
Traverse is to be configured	Fn Content . Refer to "58.6 Configuring Traverse".

58.3

Creating/Editing a Traverse

Access

- In **Traverse**, select **Create a new traverse**. Press **OK**.
- In **Manage Traverses**, press **New** or **Edit**.

New Traverse/ Edit Traverse



Key	Description
OK	To store the settings.
Fn Settings	To configure the Traverse app. Refer to "58.6 Configuring Traverse".

Description of fields

Field	Option	Description
Traverse ID	Editable field	The ID of the traverse.
Description	Editable field	A line for a detailed description of the traverse, for example, work to be performed. Optional.
Operator	Editable field	The name of the person who is creating the traverse. Optional.
Date	Display only	Available in the Edit Traverse panel. The date of when the traverse was created.
Time	Display only	Available in the Edit Traverse panel. The time of when the traverse was created.
Status		Available in the Edit Traverse panel.
	Open	The traverse is not closed in position.
	Position closed	The traverse has been closed in position on a control point.
	Posn & angle closed	The traverse has been closed both in position and angularly.

Field	Option	Description
	Adjusted	The traverse data is the result from an adjustment.

58.4

Selecting an Existing Traverse

Access

In **Traverse**, select **Choose an existing traverse**. Press **OK**.

Existing Traverse

Key	Description
OK	To accept the settings.
Data	To display traverse data. Refer to "58.5 Traverse Data". Not available for adjusted traverses.
Fn Settings	To configure the Traverse app. Refer to "58.6 Configuring Traverse".

Description of fields

The fields are identical with those fields in the **Edit Traverse** panel. Refer to "58.3 Creating/Editing a Traverse".

Next step

ENTER when **Traverse ID** is highlighted. Accesses **Manage Traverses**.

Manage Traverses

All traverses of the job are displayed.

Key	Description
OK	To confirm selection of highlighted traverse and return to Choose an existing traverse .

Key	Description
New	To create a new traverse. Refer to "58.3 Creating/Editing a Traverse".
Edit	To edit the traverse ID and description of the highlighted traverse. Refer to "58.3 Creating/Editing a Traverse".
Data	To display traverse data. Refer to "58.5 Traverse Data" for more information.
Fn Settings	To configure the Traverse app. Refer to "58.6 Configuring Traverse".

58.5

Traverse Data

Description

This panel allows the review and editing of traverse setups inside of a traverse. Allows access to **Point Results** for editing.

Access

Data in **Manage Traverses**.

OR

Data in a confirmation window of the **Point Results** panel.

Traverse Data

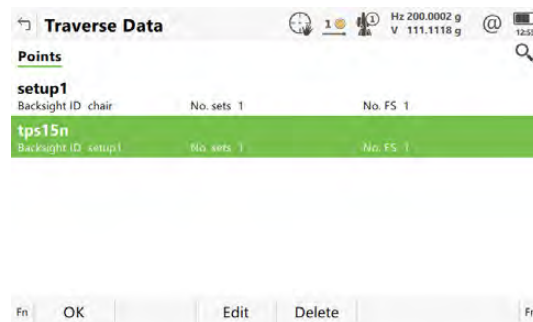

Key	Description
OK	To return to where this panel was accessed from.
Edit	To access the Point Results panel. Refer to "58.8 Traverse Point Results".
Delete	To delete the LAST traverse setup permanently.
Page	To change to another page on this panel.

Description of metadata

Metadata	Description
-	Point ID of the setup.
Backsight ID	The backsight point measured from the current setup ID.
No. sets	Number of measured sets.
No. FS	Number of measured foresight points.

58.6

Configuring Traverse

Access

Select **Leica Captivate - Home: Traverse**. Press **Fn Settings**.

Settings, Parameters page

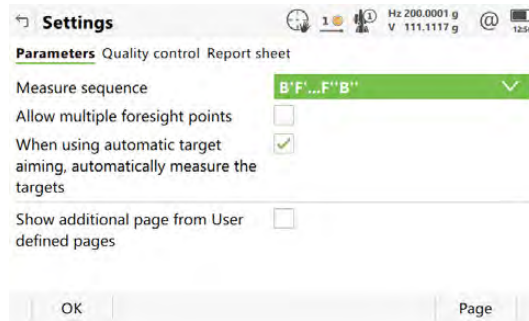

Key	Description
OK	To accept changes and to return to the panel from where this panel was accessed.
Edit	Available on the Parameters page when a list item in Page to show is highlighted. To edit the page currently being displayed. Refer to "26.2 User defined pages".
Page	To change to another page on this panel.
Fn About	To display information about the app name, the version number, the date of the version and the copyright.

Description of fields

Field	Option	Description
Measure sequence	B'F'...F'B''	All points are measured in face I, then measured in face II in reverse sequential order.
	B'F'...B''F''	All points are measured in face I, then measured in face II.
	B'B''F'F''...	Backsight point is measured in face I immediately followed by face II. Other points are measured in face I, face II order.
	B'B''F'F'...	Backsight point is measured in face I immediately followed by face II. Other points are measured in alternating face order.
	B'F'...	All points are measured in face I only.
Allow multiple foresight points	Check box	Option to define if only one foresight point or multiple points are used during the sets.
When using automatic target aiming, automatically measure the targets	Check box	For instruments with automatic aiming and this option checked, automatic aiming search and automatic aiming measurements are done to specified targets and subsequent sets.
Show additional page from User defined pages	Check box	The user-defined page to be shown in the Traverse panel.

Field	Option	Description
Page to show	Selectable list	Available when Show additional page from User defined pages is checked. The names of the available pages.

Next step

Page changes to the **Quality control** page.

Settings, Quality control page

Description of fields

Field	Option	Description
Check for errors before storing	Check box	The entered horizontal, vertical and distance tolerances are checked during the measurements to verify accurate pointing and measurements.
H_z tolerance	Editable field	Tolerance for horizontal directions.
V tolerance	Editable field	Tolerance for vertical directions.
Distance tolerance	Editable field	Tolerance for distance.
Check for backsight height	Check box	The entered height tolerance for the backsight point is checked during the measurements to verify accurate pointing and measurements.
Height limit	Editable field	Tolerance for the backsight height.

Next step

Page changes to the **Report sheet** page. Refer to "36 Apps - General".

58.7

Traverse Methods

58.7.1

Starting Traverse

Start traverse step-by-step

The quickest setup method is described.

1. Start the Traverse app.
2. **Traverse**
Select **Create a new traverse**.
3. **OK** to access **New Traverse**.
4. **New Traverse**
Type in the name of the new traverse.
5. **OK** to access **Settings**.
Check the settings.
6. **OK** to access **Total Station Setup**.
Any standard setup method can be used.
7. **Set** to set the setup and orientation.
8. A confirmation window is displayed.

Forsight pt

9. **Forsght, Set:**
Foresight ID The name of the foresight point.
Target height The target height of the foresight point.
Number of sets The number of sets to be measured.

10. **Measure** to measure and record. The measurement settings for the first measurement to each point are used for all further sets.

11. **Point Results**
OK to move to the next setup, to return to the **Point Results** panel (and set a point as a closing point), to survey a sideshot, to view traverse data or to end the traverse.

12. **Move** to move to the next setup.
 After pressing **Move**, Traverse is exited. To continue with the traverse from the next setup refer to "58.7.2 Continuing an Existing Traverse".

58.7.2



Continuing an Existing Traverse

Measure traverse step-by-step

1. Start the Traverse app.

2. **Traverse**
Select **Choose an existing traverse**.

3. **OK** to access **Existing Traverse**.

4. **Existing Traverse**
Traverse ID The name of the traverse. **ENTER** to select a different existing traverse.
 **Data** to view data of the active traverse.
 **Fn Settings** to change the working style settings.

5. **OK** to access **Backsight, Set:**
Enter **Instrument height**.
Hz, V and **Horizontal distance** The measured values are displayed.
Calc azimuth The calculated azimuth from the current setup point to the backsight point.
Difference in horizontal distance and **Difference in height** The difference between the computed and measured values.
 **More** to change between the displayed values.

6. **Measure** to measure and record the backsight point.

7. **Forsght pt** to measure a foresight point.

8. **Forsght, Set:**
Foresight ID The name of the foresight point.
Target height The target height of the foresight point.
Number of sets The number of sets to be measured.
 **Meas app** to measure sideshot points.

9. **Measure** to measure and record the foresight points. The measurement settings for the first measurement to each point are used for all further sets.

10. **Point Results**
OK

11. A confirmation window is displayed.
Move to move to the next setup.
12. Repeat steps 1. to 11. until traverse is ready to be closed.

58.7.3

Closing Traverse

Close traverse step-by-step

1. Refer to paragraph "58.7.2 Continuing an Existing Traverse" to measure a traverse. Measure a backsight on a new setup.
2. The confirmation window in **Forsght, Set:** is displayed.
Close to begin the process for closing the traverse.
3. The confirmation window to select a known point is displayed.
OK
4. The job panel for the design job is displayed.
Highlight the closing point.
5. **OK** to select the highlighted point.
6. **Forsght, Set:**
Measure to measure and record the closing point.
7. **Point Results**
OK to view traverse results.
8. **Traverse Results**
OK to display the confirmation window.
9. **C ang** to close the traverse with angular closure.
 Optionally the traverse can be adjusted.
10. Move to the closure point and start Traverse app.
11. **Traverse**
Select **Choose an existing traverse.**
12. **OK** to access **Existing Traverse.**
13. **Existing Traverse**
Traverse ID The name of the traverse to be closed is displayed.
14. **OK** to access **Close Angle.**
15. **Close Angle**
Closing method To measure onto a known point or a known azimuth.
Foresight ID The point ID of the foresight point.
Known azimuth Available for **Closing method : By known azimuth.** Known azimuth for foresight point.
16. **OK** to access **Backsight, Set:.**
17. **Measure** to measure all sets.
18. **Point Results**
OK to view traverse results.
19. **Traverse Results**
OK to exit viewing traverse results.
20. **Exit** to quit the Traverse app.

 Optionally the traverse can be adjusted.

Close traverse on internal reference

This option is used for determining the closure of a closed loop traverse, consisting of a single control point with an arbitrary backsight azimuth. This function allows completion of a traverse without having to reoccupy the initial setup to measure a closing angle. The positional closure is calculated by comparing the control position of the initial setup to the measured position of the final foresight. The angular closure is calculated by comparing the set azimuth of the initial backsight to the azimuth of the final measured leg.

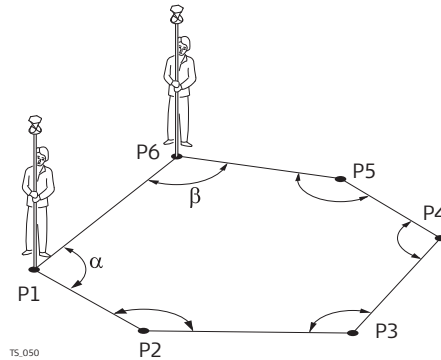

The first setup is on P1, and an assumed direction to backsight P6. Upon closing the traverse, with the last setup over P6, the closing point is P1. In this case, the only point that is considered as a control is P1.

1. The first setup is on P1 in the diagram shown. Begin the traverse, moving in the direction P1, P2...P6.
2. The last setup point is on P6 in the diagram shown. When on the last setup point, measure a backsight.
3. **Close**
4. The closing point is on P1 in the diagram shown. Select the closing point from the available list.
OK
5. Measure all the sets to the closing point as per a standard traverse.
6. **Point Results**
OK when the review of the results is completed.
7. **Yes** to confirm the automatic calculation.
8. **Traverse Results**
The traverse closure is shown with positional and angular values.

58.7.4

Creating a Control Point from Backsight by Azimuth

Description

If a traverse is to be established on existing control points, two control points must be defined to start the traverse. If the traverse absolute position is arbitrary, it can be convenient to define the control in the field with arbitrary values. This functionality is an option to turn the averaged position value into a control point when a backsight by azimuth is collected.

Access

At the beginning of a traverse, when all the measurements are completed to the backsight: On the **Point Results** panel, select **Page** to reach the **Bcksght** page. **Fn Design**.

OR

Anytime during the traverse: On the **Traverse Data** panel, highlight the first setup then **Edit**. On the **Point Results** panel, select **Page** to reach the **Bcksght** page. **Fn Design**.

58.8

Traverse Point Results

Description

Point observation results are displayed on this panel.

Access

Is displayed automatically after measuring all sets from the current setup.

Point Results, Foresight page and Bcksght page

The screenshot shows the 'Point Results' panel with the following data:

Field	Value
Point ID	tps15
Target height	1.500 m
Point type	Foresight
No. of used sets	1/1
Hz arc average	0.0003 g
V average	111.1112 g
Distance average	13.875 m

At the bottom, there are navigation buttons: Fn, OK, Add sets, Sets, Close, More, Page, and Fn.

Key	Description
OK	While measuring a traverse: Displays a confirmation window with traverse measurement options. Otherwise: To return to Traverse Data .
Add sets	To add more sets while still at the setup. It could be necessary on particular legs of a traverse that more than the designated number of sets is required. Possibly some of the sets from the first run exceeded the tolerance limit and must be disabled.
Sets	To include or exclude measured sets in the calculation of a foresight point. Check a set to include it into the calculation. Uncheck a set to exclude it from the calculation.
Close	To set a point as a closing point if not selected before measurement. Or to revert a closing point to a normal foresight.
More	To display additional information.
Page	To change to another page on this panel.
Fn Settings	To configure the Traverse app. Refer to "58.6 Configuring Traverse".
Fn Edit	To edit point code and annotations.
Fn Check	Available on the Foresight page. To check inverse distances and closure between the selected point and a point from the fixpoint job.
Fn Design	Available on the Bcksght page of the initial setup. Refer to "58.7.4 Creating a Control Point from Backsight by Azimuth".

Description of fields

Field	Option	Description
Point ID	Selectable list or display only	Selected point ID.
Target height	Selectable list or display only	The target height of the target point.
Point type	Foresight, Closing point or Closing angle	Available on the Foresight page. The current point type.
No. of used sets	Display only	Available on the Foresight page. The number of sets out of all measured sets used for the calculation.
Number of sets	Display only	Available on the Bcksight page. The number of sets the point was measured in.
Hz arc average	Display only	Average horizontal angle.
V average	Display only	Average vertical angle.
Distance average	Display only	Average distance.
Hz arc standard deviation	Display only	Standard deviation of horizontal angle.
V standard deviation	Display only	Standard deviation of vertical angle.
Distance standard deviation	Display only	Standard deviation of distance.
Hz spread	Display only	Spread of horizontal angle.
V spread	Display only	Spread of vertical angle.
Distance spread	Display only	Spread of distance.

Next step

Page changes to the **Stn info** page.

Point Results, Stn info page

Description of fields

Field	Option	Description
Setup ID	Display only	The ID of the instrument setup.
Instrument height	Editable field	Current instrument height. Editable.
Easting	Display only	Easting value of the setup position.

Field	Option	Description
Northing	Display only	Northing value of the setup position.
Height	Display only	Orthometric height of the setup position.
Scale	Display only	Scale factor used in the calculation.
Temperature	Display only	Temperature set on the instrument.
Pressure	Display only	Atmospheric ppm set on the instrument.

Next step

IF accessed	THEN
after sets measurement	<p>OK opens a confirmation window with options that depend on the traverse status:</p> <ul style="list-style-type: none"> For an open traverse: Move to next setup, return to Point Results, to survey a sideshot, to view traverse data or to quit the Traverse app. For a closed traverse: Move to close angle, return to Point Results, to survey a sideshot, to adjust the traverse or to quit the Traverse app.
from Traverse Data	OK returns to Traverse Data .

58.9

Traverse Results

Description

Traverse closure results are displayed on this panel.

Access

Is displayed automatically after the traverse closing point is measured or selected.

Traverse Results, Position page

Position	Angle
Starting point	setup1
Closing point	tps019
Length of error	52.914 m
Direction of error	0.2758 g
Height difference	-6.824 m
Total distance	40.993 m
2D accuracy	1/0

Key	Description
OK	To move to close angle, to survey a sideshot, to adjust the traverse or to quit the Traverse app.
N & E or L & D	To view the misclosure error in north/east or length/direction.
Adjust	To adjust the traverse.
Data	To display traverse data.

Key	Description
Page	To change to another page on this panel.
FnSettings	To configure the Traverse app. Refer to "58.6 Configuring Traverse".

Description of fields

Field	Option	Description
Starting point	Display only	The point ID of the traverse start point.
Closing point	Display only	The point ID of the traverse closing point.
Length of error	Display only	The length of the misclosure error.
Direction of error	Display only	The direction of the misclosure error.
Difference north	Display only	Error in north.
Difference east	Display only	Error in east.
Height difference	Display only	Error in height.
Total distance	Display only	Total length of the traverse.
2D accuracy	Display only	Position ratio of misclosure.
1D accuracy	Display only	Height ratio of misclosure.

Next step

Page changes to the **Angle** page.

Traverse Results, Angle page

Description of fields

Field	Option	Description
Foresight ID	Display only	Point ID of the closing angle point. Displays ----- if no values are available.
Known azimuth	Display only	Defined azimuth of closing line. Displays ----- if no values are available.
Azimuth average	Display only	Mean value of the measured azimuth closing line. Displays ----- if no values are available.
Angular misclosure	Display only	Angular misclosure of traverse. Displays ----- if no values are available.

Next step

OK to move to close angle, to survey a sideshot, to adjust the traverse or to quit the app.

58.10

Traverse Adjustment

58.10.1

Accessing Traverse Adjustment

Description

- A traverse adjustment can be performed on three components: 2D positions, angles and elevations.
- Various adjustment methods are available for selection. Once the adjustment is performed, the results can be reviewed. Adjusted points are stored into a new job, and a report can be generated.
- If the message panel appears which requires that the app must be activated using a licence key then refer to "29.3 Load licence keys".



Survey points have to be measured while Traverse is running to be part of the adjustment calculations.

Access

The traverse adjustment option can be reached in different ways based on specific conditions.

Upon completing the observations onto the closing point, **Adjust** to access **Traverse Adjustment**.

OR

After the measurements are done on the closing line for angular closure, **Adjust** to access **Traverse Adjustment**.

OR

When the traverse is closed: **Result** in **Traverse Data**, then **Adjust** in **Traverse Results** to access **Traverse Adjustment**.

Traverse Adjustment, Method page

Traverse Adjustment

Method

Traverse ID: 1

Horiz adjustment: Compass rule

Angle balance: No distribution

Vert adjustment: Equally

Fn OK Fn

Key	Description
OK	To calculate the result.
Page	To change to another page on this panel.
Fn Settings	To configure the Traverse app. Refer to "58.6 Configuring Traverse".

Description of fields

Field	Option	Description
Traverse ID	Display only	The ID of the traverse.
Horiz adjustment	Compass rule	Suitable for surveys, where angles and distances were measured with equal precision.

Field	Option	Description
	Transit rule	Suitable for surveys, where angles were measured with a higher precision than the distances.
	No distribution	No distribution is made.
Angle balance	Equally	The angle misclosure is distributed equally.
	No distribution	No distribution is made.
Vert adjustment	Equally	The height error distributed equally.
	By distance	The height error distributed by distance.
	No distribution	No distribution is made.

Next step

OK starts the adjustment calculation.

58.10.2

Adjustment Results

Description

The results of the adjustment calculations can be reviewed by accessing the different pages.

Access

OK in **Traverse Adjustment**.

Adjustment Results, Position page

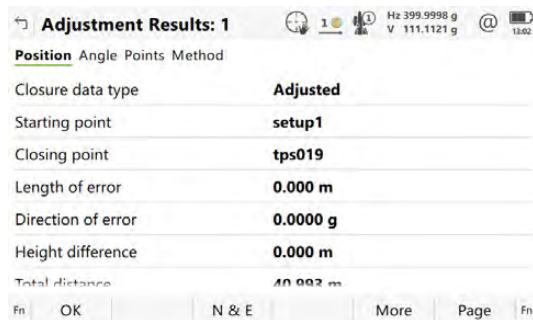

Key	Description
OK	To access the next panel.
N & E or L & D	To view the misclosure error in north/east or length/direction.
More	To display the values for the unadjusted, the balanced and the adjusted solution.
Page	To change to another page on this panel.
Fn Settings	To configure the Traverse app. Refer to "58.6 Configuring Traverse".

Description of fields

Field	Option	Description
Closure data type	Adjusted, Unadjusted or Balanced	More to change between the options and display the values accordingly.
Starting point	Display only	The point ID of the traverse start point.
Closing point	Display only	The point ID of the traverse close point.
Length of error	Display only	The length of the misclosure error.
Direction of error	Display only	The direction of the misclosure error.
Difference north	Display only	Error in north.
Difference east	Display only	Error in east.
Height difference	Display only	Error in height.
Total distance	Display only	Total length of the traverse.
2D accuracy	Display only	Position ratio of misclosure.
1D accuracy	Display only	Height ratio of misclosure.

Next step

Page changes to the **Angle** page.

Adjustment Results, Angle page

Description of fields

Field	Option	Description
Closure data type	Display only	More to change between the options.
Known azimuth	Display only	Defined azimuth of closing line. Displays ----- if no values are available.
Azimuth average	Display only	Mean value of the measured azimuth closing line. Displays ----- if no values are available.
Angular misclosure	Display only	Angular misclosure of traverse. Displays ----- if no values are available.

Next step

Page changes to the **Points** page.

Adjustment Results, Points page

The adjusted points are listed including the function for each point.

Display shows the coordinate values of the highlighted point.

Next step

Page changes to the **Method** page.

**Adjustment Results,
Method page**

The adjustment methods previously selected in **Traverse Adjustment** and used for the adjustment are displayed.

Next step

3D viewer provides an interactive display of the data.

OK accesses **Adjustment Store**.

Adjustment Store

Description of fields

Field	Option	Description
Traverse ID	Display only	The ID of the traverse.
Store adjusted job to	Selectable list	The location to save the adjusted job.
New job	Editable field	The new job name. Once adjustment results have been reviewed and accepted, the adjusted position of the points is stored in a separate job.
Include measured points	Check box	Survey points can be included or not. Adjusted points are stored in the new job as a triplet of class Adjusted (Adj) .
Store point ID with	Same point ID	Adjusted points are stored in the new job with the original point IDs.
	Prefix	Adjusted points are stored in the new job with a prefix in front of the original point IDs.
	Suffix	Adjusted points are stored in the new job with a suffix at the end of the original point IDs.
Prefix / suffix	Editable field	Available when Prefix or Suffix is selected in Store point ID with . The value that is added to the front or end of the original point ID.

Next step

Store stores the results.

59.1

Overview

Description

The Volume Calculations app allows surfaces to be measured and volumes (and other information) to be computed from these surfaces.

Volume calculations tasks

The Volume calculations app can be used for the following tasks:

- Measuring points (surface points and boundary points) defining a new surface or extending existing surfaces from the job.
- Calculating the triangulation of the measured surface points to establish the surface.
- Calculating volumes from a base (3D point, entered elevation) or by a stockpile method.

The surface calculation can be made from:

- existing point data in the job.
- manually occupied points.
- entered coordinates.

Activating the app

If the message panel appears which requires that the app must be activated using a licence key then refer to "29.3 Load licence keys".



Volume Calculations are possible for RTK rover and TS.

Point types

Surfaces can be created from points stored as:

- Local grid
- Height mode can be ellipsoidal or orthometric.

Heights and positions are always taken into account. Points must have full coordinate triplets.

59.2

Accessing Volumes & Surfaces

Access

Select **Leica Captivate - Home: Volume calc.**

Volume Calculations

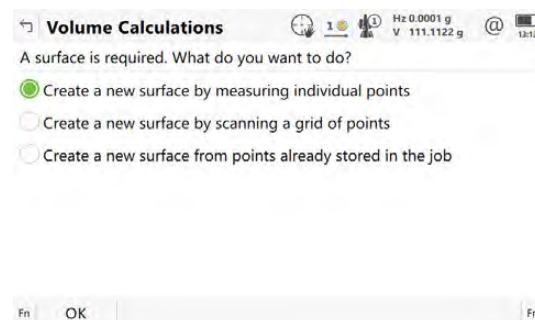

Key	Description
OK	To select the highlighted option and to continue with the subsequent panel.

Key	Description
Fn Settings	To configure the Volume Calculations app. Refer to "59.3 Configuring Volumes & Surfaces".

Description of options

Option	Description
Create a new surface by scanning a grid of points	Available in TS mode.
Choose an existing surface	Available when surfaces exist in the job.

59.3

Configuring Volumes & Surfaces

Access

Select **Leica Captivate - Home: Volume calc.** Press **Fn Settings**.

Refer to "36 Apps - General" for information on the **Report sheet** page.

59.4

Calculating Volumes

59.4.1

Create a New Surface by Measuring New Points

Access

Select **Create a new surface by measuring individual points** in **Volume Calculations**.

New Surface

Description of fields

Field	Option	Description
Surface name	Editable field	The name/number of the new surface.

Next step

OK to access **Define Grid Scan Area**.

Measure Surface Points, page

The pages shown are from a typical working style. An extra page is available when a user-defined page is used.

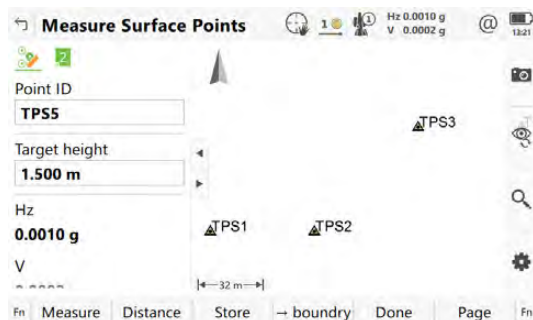

Key	Description
Measure	For GS: To start measuring the surface point. The key changes to Stop .
Measure	For TS: To measure a distance and store distance and angles.
Stop	For GS: To end measuring the surface point. The key changes to Store .
Distance	For TS: To measure a distance.
Store	To store the measured surface point. The key changes to Measure .
Near	For GS: To search the job for the point nearest to the current position when the key is pressed. The point is selected as the point to be measured and is displayed in the first field on the panel. After measuring and storing the nearest point, the next point suggested is the one which was suggested before the key was pressed. Available when Measure is displayed.
→ boundary and → surface	To change the type of point to be measured between surface point and boundary point.
Done	To finish measuring.
Page	To change to another page on this panel.
Fn Settings	To configure SmartCode and auto point measurements.
Fn Display	To configure what is displayed in the 3D viewer.
Fn Tools	Refer to "37 Apps - The Toolbox".
Fn Connect and Fn Disconnect	For GS: To connect/disconnect from the GPS reference data.

Description of fields

Field	Option	Description
Point ID	Editable field	The identifier for measured points. The configured point ID template is used. The ID can be changed: <ul style="list-style-type: none"> To start a new sequence of point IDs overtype the point ID. For an individual number independent of the ID template Fn Tools.

Field	Option	Description
Antenna height	Editable field	For GS: The antenna height as defined in the active working style is suggested. Changes in the antenna height do not update the antenna height as defined in the active working style. The changed antenna height is used until the app is exited.
3D quality	Display only	For GS: The current 3D coordinate quality of the computed position.
Target height	Editable field	For TS: The last used target height is suggested when accessing this panel. An individual target height can be typed in.
Hz	Display only	For TS: The current horizontal angle.
V	Display only	For TS: The current vertical angle.
Horizontal distance	Display only	For TS: The horizontal distance after Distance was pressed. No distance is displayed when accessing the panel and after Store or Measure .
Difference in height	Display only	For TS: The height difference between setup and measured point after Distance was pressed. Displays ----- when accessing the panel and after Store or Measure .

Next step

Measure all points. Then press **Done**.

59.4.2

Create a New Surface by Using Grid Scan

Access

For TS:

Select **Create a new surface by scanning a grid of points** in **Volume Calculations**.

New Surface

Description of fields

Field	Option	Description
Surface name	Editable field	The name/number of the new surface.

Next step

OK to access **Define Grid Scan Area**.

Grid scan points to surface

Refer to "42.9 Grid Scan on Surface - TS" for defining the grid scan area, defining the scan settings as well as starting and ending grid scanning.

59.4.3

Create a New Surface from Previously Stored Points

Access

Select **Create a new surface from points already stored in the job** in **Volume Calculations**.



When accessing the **Edit Surface** panel after selecting **Create a new surface from points already stored in the job** the **Points** page is active. Any other time this panel is accessed the **General** page is active.

New Surface

Description of fields

Field	Option	Description
Surface name	Editable field	The name/number of the new surface.

Next step

OK to access **Edit Surface** after points being added.

Edit Surface, General page

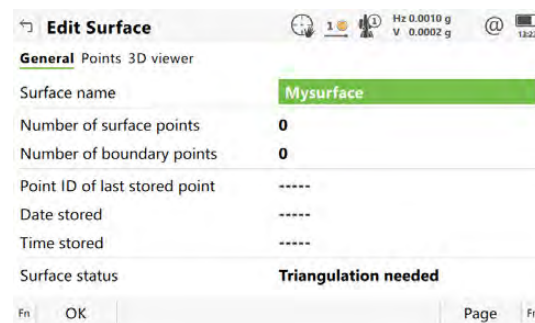

Key	Description
OK	To accept all settings and continue with the next panel.
Page	To change to another page on this panel.
Fn Settings	To configure the app. Refer to "59.3 Configuring Volumes & Surfaces".

Description of fields

Field	Option	Description
Surface name	Selectable list	Name of the surface to be triangulated.
Number of surface points	Display only	Number of points inside the surface.
Number of boundary points	Display only	Number of boundary points of the surface.

Field	Option	Description
Point ID of last stored point	Display only	ID of the last measured point of the chosen surface.
Date stored	Display only	Date of the last measured point of the chosen surface.
Time stored	Display only	Time of the last measured point of the chosen surface.
Surface status	Triangulation done	The surface has been triangulated and not been modified since the last triangulation.
	Triangulation needed	The surface has been modified since the last triangulation or no triangulation exists.

Next step

Page changes to the **Points** page.

Edit Surface, Edit Surface page

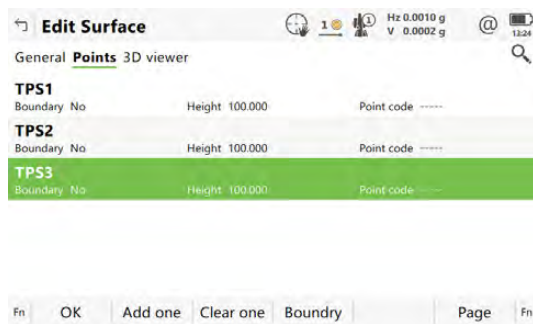

Key	Description
OK	To accept all settings and continue with the next panel.
Add all	To add one point from the job to the surface.
Clear one	To remove one point from the surface.
Boundry	To use this point for the boundary.
Page	To change to another page on this panel.
Fn Settings	To configure the Volume Calculations app. Refer to "59.3 Configuring Volumes & Surfaces".
Fn Add all	To add all points from the job to the surface.
Fn Clear all	To remove all points from the surface.

Next step

OK continues to **Surface Task Selection**.

59.4.4

Choosing an Existing Surface

Access

Select **Choose an existing surface** in **Volume Calculations**.

Existing Surface

The fields available are identical with the fields in **Surface status, General** page. Refer to "59.4.3 Create a New Surface from Previously Stored Points".

Next step

Select the desired surface ID then press **OK**. **OK** continues to **Surface Task Selection**. Refer to 59.4.5 Selecting the Surface Task.

59.4.5

Selecting the Surface Task

Surface Task Selection

Description of the options

Options	Description
Add more points to the surface by measuring individual points	To measure points defining a new surface or extending existing surfaces and boundaries by surveying. Refer to "59.4.1 Create a New Surface by Measuring New Points".
Add more points to the surface by scanning a grid of points	To add more points to the surface by grid scanning new points. The grid scan procedure restarts.
Review & edit the surface	To view the surface summary and add/remove points from the surface. Refer to "59.4.3 Create a New Surface from Previously Stored Points".
Edit the boundary & triangulate surface	To define/redefine the boundary using manual point selection, or one of the existing automatic methods, and then create a triangulation. A DXF model can then be exported if desired. Refer to "59.4.6 Boundary Definition".
Calculate the volume	Available after the surface has been triangulated. To compute the volume of a surface by a reference (3D point, entered elevation) or by the stockpile method. Refer to "59.4.7 Compute Volumes".
Exit the app	To end the app and return to the panel from where Volume Calculations was accessed.

Next step

Select the task to do next. **OK** selects an option.

Edit Boundary, Points page

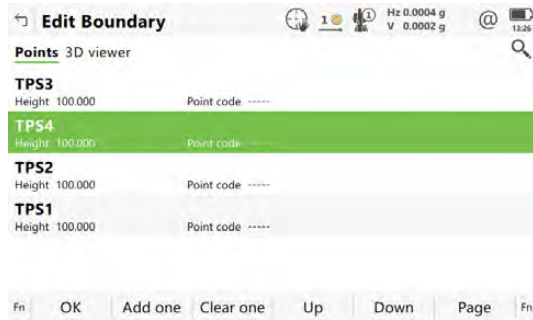

Key	Description
OK	To start calculating the triangulation.
Add one	To add points from the job to the surface.
Clear one	To remove the marked point from the boundary definition or completely from the surface.
Up	To move up the focused point one step within the boundary definition.
Down	To move the focused point one step down within the boundary definition.
Page	To change to another page on this panel.
Fn Settings	To configure the Volume Calculations app. Refer to "59.3 Configuring Volumes & Surfaces".
Fn Tools	To access the Boundary Tools Menu .

Edit Boundary, 3D viewer page

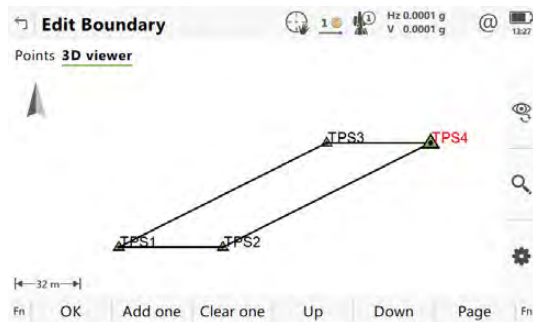

Key	Description
OK	To start calculating the triangulation.
Add one	To add points from the job to the surface.
Clear one	To remove the marked point from the boundary definition or completely from the surface.
Up	To move up the focused point one step within the boundary definition.
Down	To move the focused point one step down within the boundary definition.
Page	To change to another page on this panel.

Key	Description
Fn Settings	To configure the Volume Calculations app. Refer to "59.3 Configuring Volumes & Surfaces".
Fn Display	To configure what is displayed in 3D viewer.
Fn Layers	To turn CAD layers on or off.
Fn Tools	To access the Boundary Tools Menu .

Next step

IF you want to	THEN
check the triangulation results	OK to access Triangulation Results .

Triangulation Results

The **Summary** page and the **Details** page contain only display only fields. Information such as the number of triangles/surface points/boundary points, the minimum/maximum elevation or the 3D area is shown.

3D viewer contains a plot of the triangles of the triangulation and also its boundary.

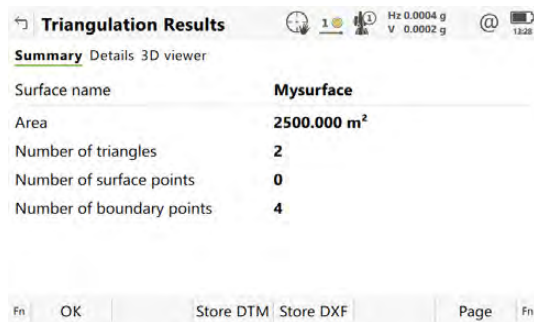

Key	Description
OK	To return to Surface Task Selection .
Store DTM	To go to a panel where the surface can be saved as DTM job.
Store DXF	To go to a panel where the triangulation can be saved as a DXF.
Page	To change to another page on this panel.
Fn Settings	To configure the report sheet.

Boundary Tools Menu

Description of fields

Field	Description
Add multiple points	Lists all points in the job.
Remove all points	Method to remove all points that are indicated in Edit Boundary, Points page.
Sort points by time	Method to sort all points in Edit Boundary, Points page by the time they were stored.
Sort points by proximity	Method to sort all points Edit Boundary, Points page by the closest proximity.

Field	Description
Compute rubber band bndry	Method to define a new boundary as if a rubber band was placed around the points. The current list of boundary points are ignored.

Next step

Select the task to do next. **OK** selects an option and returns to the boundary definition.

59.4.7

Compute Volumes

Volume Calculation

Key	Description
OK	To compute the volume.
Lowest ht	Available for Volume calculation method: Surface to entered height . To enter the smallest possible value for Height automatically.
Fn Settings	To configure the app. Refer to "59.3 Configuring Volumes & Surfaces".

Description of fields

Field	Option	Description
Surface name	Selectable list or display only	Surface chosen from the triangulated surfaces currently stored to the job.
Number of triangles	Display only	Number of triangles from the triangulation of the surface.
Volume calculation method		To calculate the volume of the triangulated surface.
	Stockpile	Volume between the triangulated surface and the DTM surface defined by the boundary points of the surface.
	Surface to entered height	Volume between the triangulated surface and the entered height.
	Surface to point	Volume between the triangulated surface and the height of a selected point.

Field	Option	Description
Height	Editable field or display only	The height to which the volume is calculated.

Next step

OK calculates the volume and continues to **Volume Calculation Results**.

Volume Calculation Results, Summary page

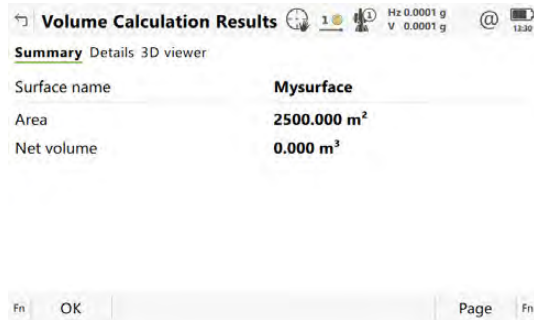

Key	Description
OK	To close the triangulation of the surface.
Page	To change to another page on this panel.
Fn Settings	To configure the app. Refer to "59.3 Configuring Volumes & Surfaces".

Description of fields

Field	Option	Description
Surface name	Display only	Name of the surface used for the calculation. Available for Volume calculation method: Surface to entered height and Volume calculation method: Surface to point .
Point ID	Display only	The point to which the volume is calculated. Available for Volume calculation method: Surface to point .
Height	Display only	The elevation of the point to which the volume is calculated. Available for Volume calculation method: Surface to entered height and Volume calculation method: Surface to point .
Area	Display only	Area of the base plane.
Net volume	Display only	Volume of the surface.
Volume above reference surface	Display only	Cut of the volume. Available for Volume calculation method: Surface to entered height and Volume calculation method: Surface to point .

Field	Option	Description
Volume below reference surface	Display only	Fill of the volume. Available for Volume calculation method: Surface to entered height and Volume calculation method: Surface to point .

Next step

Page changes to the **Details** page.

Volume Calculation Results, Details page

Description of fields

Field	Option	Description
Minimum elevation	Display only	Minimal elevation of the triangulated surface.
Maximum elevation	Display only	Maximal elevation of the triangulated surface.
Average thickness	Display only	Average thickness of the calculated volume.
Perimeter	Display only	Perimeter of the measured surface area. Intersection of the measured surface to the reference datum.

60

Inspect Surfaces

60.1

Overview

Description

The app can be used to compare two surfaces.

The surfaces can be defined by scans, points, planes or solid.

The result is displayed in a map but can be shown as statistics, exported as report or exported as surface.

Activating the app

If the message panel appears which requires that the app must be activated using a licence key then refer to "29.3 Load licence keys".

60.2

Accessing Inspect surfaces

Access

Select **Leica Captivate - Home: Inspect surfaces**.

Define Reference Surface

Define the reference surface to which another surface is compared to.

Key	Description
OK	To select the highlighted option and to continue with the subsequent panel.
Fn Settings	To configure the app. Refer to "60.3 Configuring Inspect surfaces".

Description of options

Option	Description
By scanning a new surface	Available in TS mode.
From existing scans	Available when surfaces exist in the job. To create a reference surface from existing scans in the selected job.
From existing points	To create a reference surface from points in the selected job.
From a pre-defined plane or solid	Select from: <ul style="list-style-type: none">• Horizontal plane Choose or measure a point to define the height of the horizontal plane.• Vertical plane Choose or measure two points to define the orientation of the vertical plane.• Plane defined by three points Choose or measure three points to define the plane.• Cylinder Choose or measure two points to define the axis of the cylinder and enter the radius of the cylinder.• Cone Choose or measure two points to define the axis of the cone, and enter the radius for the two bases.

Option	Description
From a point cloud or .dxf file	Import DXF, PTS or ASCII data. A surface will be created based on the triangulation settings in Settings .

60.3

Configuring Inspect surfaces

Access

In **Define Reference Surface**, press **Fn Settings**.

Settings,
Display page

Description of fields

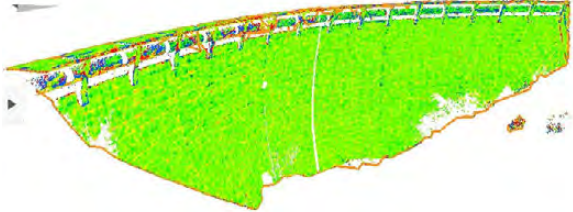
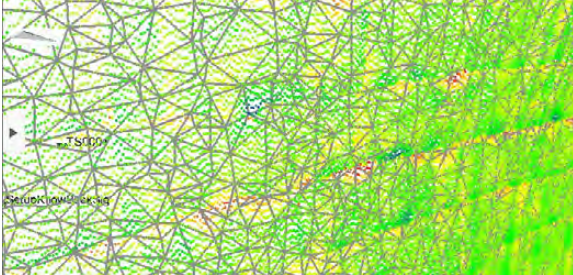
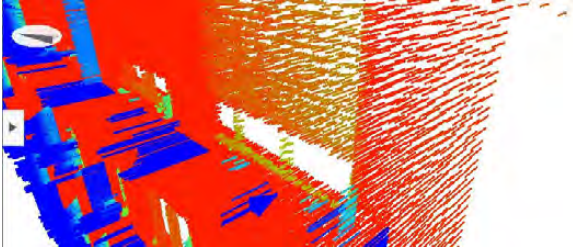
Field	Option	Description
Boundary of the triangulated reference surface	Check box	When this box is checked, a contour line is displayed in orange. A contour line defines the limits for the DTM. 
Mesh triangulation	Check box	When this box is checked, mesh lines are displayed. A mesh is a collection of vertices, edges, and faces that describe the shape of the reference surface. 
Normal vector from points to reference surface	Check box	When this box is checked, the normal to the surface is shown as a vector. 

Field	Option	Description
Pre-defined plane / solid	Check box	When this box is checked, a pre-defined plane or solid is displayed in the comparison map.

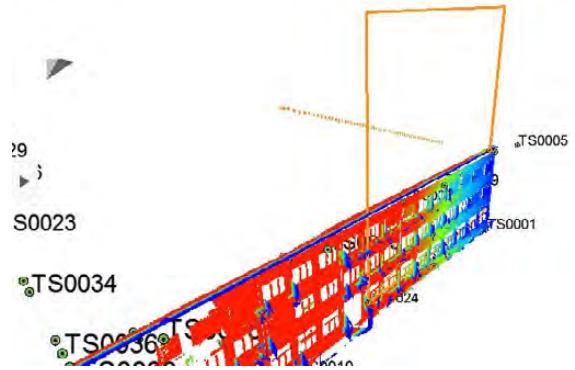

Point cloud point size

To change the pixel size of a single scan point displayed in the viewer. To best view the scan points in different areas.

Small

A small point represent each scan point.

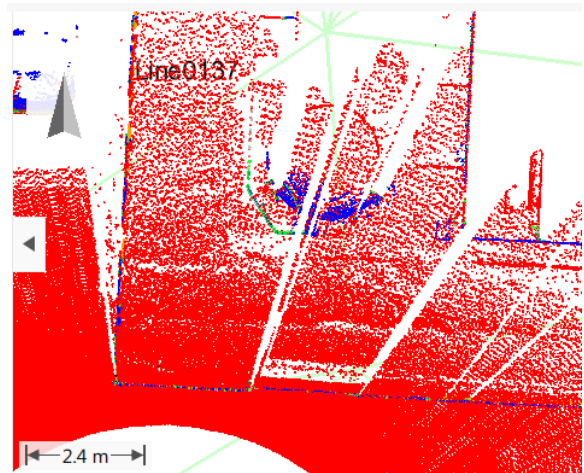

Large

A large point represent each scan point.

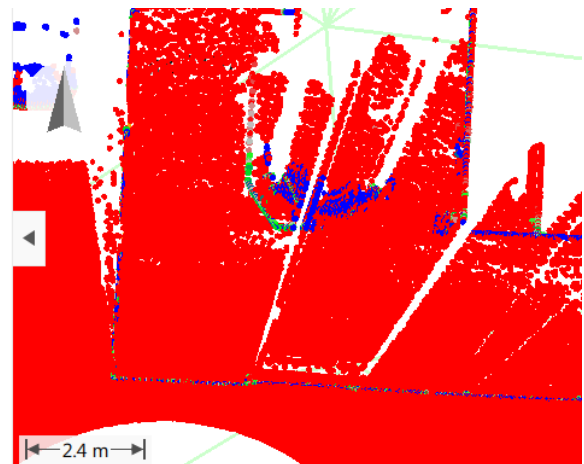

Next step

Page changes to the **Projection** page.

Settings, Projection page

Description of fields

Field	Option	Description
Lower distance	Editable field	The minimum distance from the reference surface which is projected.
Upper distance	Editable field	The maximum distance from the reference surface which is projected.
Reverse the projection direction	Check box	When this box is checked, the direction of the projection is in the opposite direction to the original. When creating the surface from an imported DXF, the positive direction of the plane is unknown. The positive direction of the plane must be known to decide if the point is inside or outside of the plane. Use this option to find out the positive direction of the plane.

Next step

Page changes to the **Triangulation** page.

Settings, Triangulation page

Key	Description
OK	To accept changes and return to the panel from where this panel was accessed.
Page	To change to another page on this panel.

Description of fields

Field	Option	Description
Create a rough triangulation	Check box	When this box is checked, the speed of the calculation is increased when the surface contains more than 1000 points. Points outside the limits defined for Maximum distance to neighbouring groups of points and Minimum distance to surface are excluded from the triangulation.
Maximum distance to neighbouring groups of points	Editable field	When Create a rough triangulation is checked, points beyond this defined distance are excluded from the triangulation.
Minimum distance to surface	Editable field	When Create a rough triangulation is checked, points closer to the surface are excluded from the triangulation.













Next step

Page changes to the **Colour scale** page.

Settings, Colour scale page

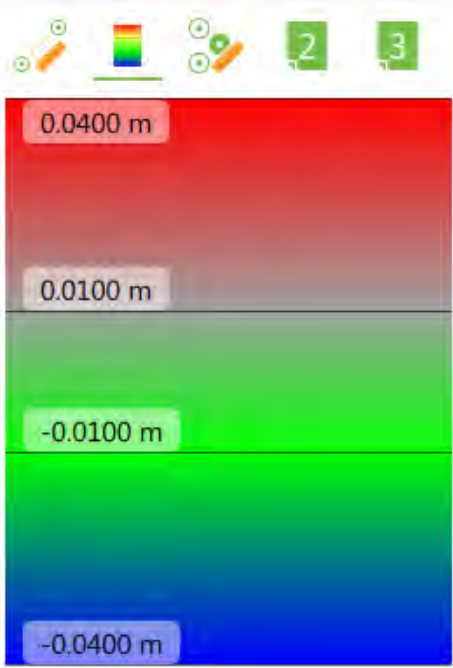
Define the colours for distance ranges. When the surfaces are compared, the colours show the distance ranges to the reference plane in the 3D viewer.

The colour range corresponds to the legend in the **Measure Mode** panel.

Settings, Colour scale page	Measure Mode												
<table border="1"><tr><td>0.0400 m</td><td></td><td>▼</td></tr><tr><td>0.0100 m</td><td></td><td>▼</td></tr><tr><td>-0.0100 m</td><td></td><td>▼</td></tr><tr><td>-0.0400 m</td><td></td><td>▼</td></tr></table>	0.0400 m		▼	0.0100 m		▼	-0.0100 m		▼	-0.0400 m		▼	
0.0400 m		▼											
0.0100 m		▼											
-0.0100 m		▼											
-0.0400 m		▼											

Key	Description
OK	To accept changes and return to the panel from where this panel was accessed.
Insert	To add a line for distance and colour definition. The new line is inserted below the line which is highlighted.
Delete	To remove the highlighted line.
Page	To change to another page on this panel.
Fn Load	To load a template for the colour scale range. The templates are stored in the instrument configuration. Templates can not be copied to another instrument.
Fn Save	To save the current definition of distances and colours as template for the colour scale range.

Description of fields

Field	Option	Description
Distance	Editable field	Click in the field and enter a distance. Tap outside the field to stop the editing process. The distance entered, is shown in the colour selected in the adjoining Colour field is used. For a smooth transition to the colour applying to the distance field below, the colours are shaded.
Colour	Selectable list	The selected colour is used to display the objects at the defined distance. Click on the field to open the selectable list. Scroll up and down to see the whole colour range. Tap on a colour for selection. Tap outside the field to stop the selection process.

60.4

Creating a Reference Surface

60.4.1

From Existing Scans

Access

Select **From existing scans** in **Define Reference Surface**.

Select Scans

Check the box in front of a scan ID to select a scan to use.
Uncheck the box in front of a scan ID to deselect a scan.

Key	Description
OK	To continue to the next panel.
Fn Settings	To configure the app. Refer to "60.3 Configuring Inspect surfaces".
Fn Delete	To delete the highlighted scans.
Fn None or Fn All	To deactivate or activate all scans for the reference plane definition.

Next step

OK to access **Define Object to Compare**.

60.4.2

From Existing Points

Access

Select **From existing points** in **Define Reference Surface**.

Select Points, 3D viewer page

Tap on the points forming the reference surface.
Or select a point from the points list on the **Points** page. Refer to "7.2 Accessing Data Management".

Key	Description
OK	To continue to the next panel.
Fn Settings	To configure the app. Refer to "60.3 Configuring Inspect surfaces".
Fn Display	To configure what is displayed in 3D viewer.
Fn Layers	To turn CAD layers on or off.
Fn Filter	To define sort and filter settings. Refer to "7.6 Point Sorting and Filters".
Fn Page	To change to another page on this panel.

Next step

OK to access **Define Object to Compare**.

60.4.3

From a Pre-Defined Plane or Solid

Access

Select **From a pre-defined plane or solid** in **Define Reference Surface**.

Select from:

- **Horizontal plane**
Choose or measure a point to define the height of the horizontal plane.
- **Vertical plane**
Choose or measure two points to define the vertical plane.
- **Plane defined by three points**
Choose or measure three points to define the plane.
- **Cylinder**
Choose or measure two points to define the axis of the cylinder and enter the radius of the cylinder.
- **Cone**
Choose or measure two points to define the axis of the cone, and enter the radius for the two bases.

Define plane or cylinder

Key	Description
OK	To continue to the next panel.
Meas app	To measure a point manually for the plane definition. Available when Point , 1st point , 2nd point or 3rd point is highlighted.
Fn Settings	To configure the app. Refer to "60.3 Configuring Inspect surfaces".

Description of fields

Field	Option	Description
Point	Selectable list	The point ID of the point defining the height of a horizontal plane. Available for Horizontal plane (defined by one point) .

Field	Option	Description
1st point and 2nd point	Selectable list	The point ID of points which are part of a vertical, tilted or cylindrical plane. Available for Vertical plane (defined by 2 points) , Plane (defined by 3 points) and Cylinder (2 points & radius) .
3rd point	Selectable list	The point ID of a point belonging to a tiled plane. Available for Plane (defined by 3 points) .
Radius	Editable field	The radius of the cylinder or cone. Value must be between 0.0010 m and 500 m. Available for Cylinder (2 points & radius) and for Cone (2 points & 2 radii) .

Next step

OK to import the data and to access **Define Object to Compare**.

60.4.4

From a Point Cloud or .dxf File

Requirements

The requirements depend on the selected file format:

- At least one ASCII file with any file extension, is stored in the \DATA or \GSI directory of the data storage device.
- At least one file in DXF format with the file extension *.dxf has to be stored in the \DATA directory of the data storage device.
- At least one file in PTS format with the file extension *.pts has to be stored in the \DATA directory of the data storage device.



Do not remove the data storage device while importing the data.

Access

Select **From a point cloud or .dxf file** in **Define Reference Surface**.

Import Data

Key	Description
OK	To import the data.
Fn Settings	To configure the app. Refer to "60.3 Configuring Inspect surfaces".

Description of fields

Field	Option	Description
Data type to import	Selectable list	Defines if ASCII, PTS or DXF data is imported.
	PTS data	The PTS format does not retain any original scan or registration information. The PTS format is often used when exporting final registered point clouds that have been unified.
Entities to import		Available for Data type to import: DXF data .

Field	Option	Description
	3D Face & Polyface mesh	When this option is selected, the 3D Face and Polyface mesh entities are imported. The triangulation is created based on the existing model in the DXF.
	3D Face vertices	When this option is selected, the three or four points from the 3D Face entity are imported. Only the points are imported. The surface will be created based on the triangulation settings.
	Points	When this option is selected, point objects are imported.
From	Selectable list	Defines from which storage device the data is imported.
From file	Selectable list	For Data type to import: ASCII data (point ID,E,N,Ht) and Data type to import: ASCII data (point ID,N,E,Ht) : All files in the \DATA directory on the data storage device can be selected. For Data type to import: DXF data and Data type to import: PTS data : All files with extension *.dxf or *.pts in the \DATA directory on the data storage device can be selected.

Next step

OK to import the data and to access **Define Object to Compare**.

60.4.5

From Road or Tunnel Design Data

Requirements

The requirements depend on the selected file format:

- Inspect Surfaces Road & Inspect Surfaces Tunnel are an option in the application and an additional license for each one must be loaded to be available.
- At least one Road or Tunnel job has to be stored in the \DBX directory of the data store device.

Define Design Data

Key	Description
OK	To import the data.
Fn Settings	To configure the app. Refer to "60.3 Configuring Inspect surfaces".

Description of fields

Field	Option	Description
Type of design	Road or Tunnel	Availability depends on loaded license an existing job.
Layer	Display only	The selection layer for the current Road/Tunnel job.

Field	Option	Description
Centerline	Display only	The name of the centreline.

Next step

OK to access Define Object to Compare.

60.5

Define Object to Compare

Define Object to Compare

Define the surface to which the reference surface is compared to.

Key	Description
OK	To select the highlighted option and to continue with the subsequent panel.
Fn Settings	To configure the app. Refer to "60.3 Configuring Inspect surfaces".

Description of options

Option	Description
Choose existing scan(s)	Select a scan in the same way as for the definition of the reference plane. Refer to "60.4.1 From Existing Scans".
Select points from job	Select points in the same way as for the definition of the reference plane. Refer to "60.4.2 From Existing Points".
Measure new points	Accesses the Measure Mode where measured points are compared to the defined surface.

Next step

OK to access **Define Colour Scale**.

The panel is the same as in the configuration of the app. Refer to "Settings, Colour scale page".

OK to confirm the surfaces to compare and to access **Compare Mode**.

Compare Mode and Measure Mode

The panel shows the comparison results according to the defined settings. When in measure mode, measure a point to get the comparison result. Tap on a point in the 3D viewer. The displayed values are updated.

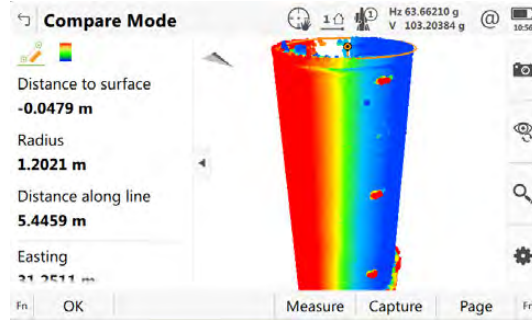

Key	Description
OK	To exit the app without storing any comparison results.
Capture	Screenshots can be taken from the display as additional information. The screenshot is displayed and can be edited by sketching. The screenshot can be linked with points manually. Sketching on the screenshot is possible.
Measure	To measure to any point and to compare it against the current reference surface.
Page	To change to another page on this panel.
Fn Settings	To configure the app. Refer to "60.3 Configuring Inspect surfaces".
Fn Tools	Refer to "60.7 The Toolbox".

Description of fields

Field	Option	Description
Distance to surface	Display only	The distance of the selected point to the reference surface.
Easting, Northing and Height	Display only	The coordinates of the selected point.
Easting projection, Northing projection and Height projection	Display only	The coordinates projected onto the reference surface.

Next step

Fn Tools to access the report options.

Access

Press **Fn Tools** on any page in the some apps.

Description

The toolbox contains additional functionality for the **Compare Mode**.

Description of options

Icon	Description
	To show a bar chart with the number of points falling into each distance range. The distance ranges are shown in their defined colour.

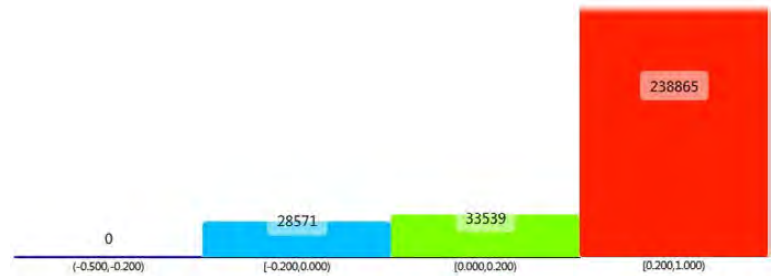

Create report

To create a report in xml format or in a defined format using a stylesheet.

```
<?xml version="1.0" encoding="UTF-8"?>
<SurfaceAnalyser appVersion="1.22.000" xmlVersion="1.01" xmlns="urn:surfaceanalyser-1.01">
  <ReferenceInfo name="Plane">
    <Plane>
      <Point z="451.122563" y="5250606.088722" x="546604.329864"/>
      <Point z="451.291747" y="5250615.346075" x="546613.288414"/>
      <Point z="451.177688" y="5250614.650646" x="546630.527154"/>
    </Plane>
  </ReferenceInfo>
  <PointCloudInfo name="sta007" pointCount="510267" source="scan"/>
  <Statistics standardDeviation="0.247490" errorMin="0.499997" errorMax="-0.499999" excludedPointCount="328541" calculatedPointCount="181726"/>
  <Histogram>
    <Bin color="#0000ff" count="24486" high="0.040000" low="-0.500000"/>
    <Bin color="#00ff00" count="1553" high="0.010000" low="-0.040000"/>
    <Bin color="#0000a0" count="1453" high="0.040000" low="0.010000"/>
    <Bin color="#ff0000" count="153178" high="0.500000" low="0.040000"/>
  </Histogram>
  <PointCloud>
    <Points>
      <Point z="453.809911" y="5250690.999127" x="546568.862997"/>
      <Projection z="453.342431" y="5250691.010241" x="546568.860349" color="#0000ff" dist="0.467620"/>
      </Point>
      <Point z="453.648915" y="5250691.001343" x="546568.859434"/>
      <Projection z="453.342408" y="5250691.008630" x="546568.857698" color="#0000ff" dist="0.306599"/>
      </Point>
    </Points>
  </PointCloud>
</SurfaceAnalyser>
```

61 QuickVolume

61.1 Overview

Description The app allows volumes to be computed from ALL scans and/or ALL measured points stored in a job.

61.2 Accessing Volume Calculations

Access Select **Leica Captivate - Home: QuickVolume**.

Surface Name

Key	Description
OK	To start the triangulation. All points and scans within the selected job are used in the triangulation.

Description of fields

Field	Option	Description
Surface name	Selectable list	Name of the surface to be triangulated.
Include all scans	Check box	When this box is checked, all scans from the job are included in the volume calculation.
Include all measured points	Check box	When this box is checked, all measured points from the job are included in the volume calculation.

61.3 Volume Calculations

Calculate Volume

Key	Description
OK	To accept all settings and continue with the next panel.
Lowest ht	To set the minimum elevation point of the current surface as elevation value. Available for Volume calculation method: Surface to entered height .

Description of fields

Field	Option	Description
Volume calculation method		To calculate the volume of the triangulated surface.
	Stockpile	Volume between the triangulated surface and the DTM surface defined by the boundary points of the surface.
	Surface to entered height	Volume between the triangulated surface and the entered height.
	Surface to point	Volume between the triangulated surface and the height of a selected point.

Next step

OK calculates the volume and continues to **Volume Calculation Results**.

Volume Calculation Results, Summary page

Key	Description
Store	To return to Surface Name .
Page	To change to another page on this panel.

Description of fields

Field	Option	Description
Surface name	Display only	Name of the surface used for the calculation.
Point ID	Display only	The point to which the volume is calculated. Available for Volume calculation method: Surface to point .
Height	Display only	The elevation of the point to which the volume is calculated. Available for Volume calculation method: Surface to entered height and Volume calculation method: Surface to point .
Area	Display only	Area of the base plane.
Net volume	Display only	Volume of the surface.
Volume above reference surface	Display only	Cut of the volume. Available for Volume calculation method: Surface to entered height and Volume calculation method: Surface to point .
Volume below reference surface	Display only	Fill of the volume. Available for Volume calculation method: Surface to entered height and Volume calculation method: Surface to point .

Next step

3D viewer provides an interactive display of the data.

Appendix A

Menu Tree

Menu tree for GS RTK rover and TS

- |-- Active job
 - |-- Job menu
 - |-- View & edit job properties
 - |-- View & edit data
 - |-- Import data
 - |--ASCII
 - |--XML
 - |--DXF
 - |--DTM
 - |--Alignment
 - |-- Export data
 - |--ASCII
 - |--ASCII with format file
 - |--DXF
 - |--XML
 - |--XML with stylesheet
 - |--Fbk, Rw5, Raw
 - |-- Send data
 - |-- Delete
- |-- Tap here to create new job
- |-- Tap here to choose design data
- |-- Create pts & lines
 - |-- Create points
 - |-- Create lines
 - |-- Create arcs
 - |-- Create polylines
 - |-- Extend existing polyline
 - |-- Create offset line & pts
- |-- Settings
 - |-- Connections
 - |--CS connection wizard (TS)
 - |--TS connection wizard (CS, not for CS35)
 - |--GS connection wizard (GS, not for CS35)
 - |--RTK rover wizard (GS)
 - |--Internet wizard (not for CS35)
 - |--All other connections
 - |-- GS Sensor (GS)
 - |--Satellite tracking
 - |--Antenna heights
 - |--GNSS raw data logging
 - |-- TS instrument (TS)
 - |--Measure & target
 - |--Target search
 - |--Atmospheric corrections
 - |--Level & compensator
 - |--Lights & accessories
 - |--Cameras
 - |--Check & adjust
 - |-- Point storage
 - |--Duplicate points
 - |--Prompt before storing
 - |--GS quality control (GS)
 - |--TS offsets & checks (TS)

- |-- Customisation
 - |--Working style wizard
 - |--User defined pages
 - |--ID templates
 - |--Hot keys & favourites
 - |--Coding
 - |--App visibility
- |-- System
 - |--Software startup
 - |--Screen, audio & text input
 - |--Regional
 - |--Restrict access
- |-- Tools
 - |--Transfer user objects
 - |--Update software
 - |--Load licence keys
 - |--Format memory
 - |--Calculator
 - |--FTP data transfer
 - |--Leica Exchange
- |-- About Leica Captivate
- |-- 3D viewer
- |-- Switch to base (not for GS08plus/CS20 GNSS)
- |-- Setup (TS)
- |-- Scanning (MS60)
- |-- Measure
 - |-- Stake points
 - |-- Stake to line
 - |-- Stake DTM
 - |-- Stake pts & DTM
 - |-- Measure to line
 - |-- QuickVolume
 - |-- Volume calc
 - |-- Traverse (TS)
 - |-- Measure sets (TS)
- |-- COGO
 - |-- Inverse
 - |-- Bearing & distance
 - |-- Intersection
 - |-- Line & arc calculation
 - |-- Shift, rotate & scale
 - |-- Area division
 - |-- Angle
 - |-- Horizontal curve
 - |-- Triangle
- |-- Stake road
- |-- Check road
- |-- Stake rail
- |-- Check rail
- |-- Stake tunnel
- |-- Check tunnel
- |-- Create coord sys
- |-- QuickGrid
- |-- Meas plane/grid
- |-- TS hidden point (TS)

**Menu tree for GS RTK
base**

- |-- Base setup
 - |-- Over known point
 - |-- Over last setup
 - |-- Over any point
 - |
 - |-- Settings
 - |-- GS base
 - |--Satellite tracking
 - |--GNSS raw data logging
 - |-- Connections
 - |--Connect to GS base
 - |--All other connections
 - |-- Switch to rover
-

Appendix B

Directory Structure of the Memory Device

Description

On the data storage device, files are stored in certain directories. The following diagram of the directory structure refers to the data storage devices and the internal memory.

All files are fully compatible with Leica SmartWorx Viva and vice versa, except for the following listed files which are not compatible between the systems:

- Working styles and settings
- System.ram and VivaSystem.zip
- Licence files
- Language files, and
- App files.

Directory structure

-- Code	• Codelists, various files
-- Config	• Working style files (*.xfg)
-- RTK_Profile	• RTK profile files (*.rpr)
-- Sketch_Template	• User-defined templates (*.jpg) for sketching
-- UserManagement	• Administration settings files (*.usm)
-- Convert	• Format files (*.fmt) • Style sheet (*.xsl) • Protected style sheets (*.lss)
-- Data	• ASCII (*.txt), DXF (*.dxf), LandXML (*.xml), Terramodel (*.xml), Carlson (*.cl) and Shape files (*.shp, *.shx and *.dbf and all other shape file components), AutoDesk (*.fbk), TDS/Carlson/MicroSurvey (*.rw5), TDS (*.raw), Bentley (*.rwd) for import/export to/from job • Section files for Carlson (*.sct) and ASCII report files for Terramodel (*.txt) for import to job • Report sheets created from apps
-- Geocom	
-- Images	
-- ATR	• Image files (*.jpg) taken with Geocom commands using the ATR.
-- Overview	• Image files (*.jpg) taken with Geocom commands using the overview camera.
-- Telescope	• Image files (*.jpg) taken with Geocom commands using the telescope camera.
-- GPS	
-- Cscs	• CSCS field files (*.csc)
-- Geoid	• Geoid field files (*.gem)
-- Rinex	• RINEX files
-- ReferenceFrame	• List of default reference frames (REFRMSET.dat)

-- Map_Images	<ul style="list-style-type: none"> • Map background image files (*.jpg, *.jgw, *.archive) • *.jpg + *.jgw with same file name = world file • *.archive = Leica Captivate format
-- Xml	<ul style="list-style-type: none"> • Alignment Editor Alignments (*.xml)
-- DBX	<ul style="list-style-type: none"> • DTM jobs, various files • Coordinate system file (Trfset.dat) • Job files for Leica SmartWorx Viva
-- Job	<ul style="list-style-type: none"> • Job files, various files. Jobs are stored in a folder per job.
--Map	<ul style="list-style-type: none"> • Map-related files (for example *.mpl), stored in a subfolder per job.
--Images	<ul style="list-style-type: none"> • Image files (*.jpg), stored in a subfolder per job.
--Scans	<ul style="list-style-type: none"> • Scan database files (*.sdb files) • Bitmaps of intensity values (*.bmp files)
--Surfaces	<ul style="list-style-type: none"> • Surface files (*.dxf)
-- Download	<ul style="list-style-type: none"> • Various files, downloaded by the FTP data transfer app (*.*)
-- GPS	<ul style="list-style-type: none"> • Antenna file (List.ant) • GSM/Modem station list (*.fil) • Server list (*.fil)
-- Gsi	<ul style="list-style-type: none"> • GSI files (*.gsi) • ASCII files for export from job (*.*)
-- System	<ul style="list-style-type: none"> • Upgrade packages for CS20/TS including firmware, apps, languages, firmware for peripheral devices (*.fw) • Special apps for CS20/TS (*.axx) • Special apps for CS35 (*.dxx) • Licence file (*.key) • Firmware files for the measurement engine (*.fw) • System files (AllObjects.zip)

Appendix C

Pin Assignments

C.1

GS08plus

Description

Some applications require knowledge of the pin assignments for the instrument ports.

In this chapter, the pin assignments and sockets for the instrument ports are explained.

Ports at the instrument underside

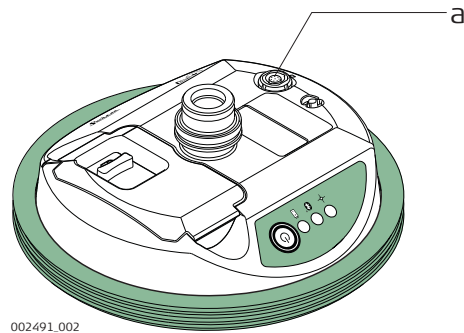

002491_002

a Lemo port (USB and serial)

Pin assignments for 8 pin LEMO-1

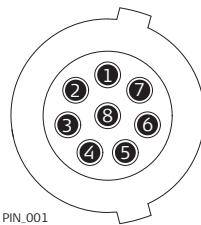

PIN_001

Pin	Signal Name	Function	Direction
1	USB_D+	USB data line	In or out
2	USB_D-	USB data line	In or out
3	GND	Signal ground	-
4	RxD	RS232, receive data	In
5	TxD	RS232, transmit data	Out
6	NC	Not connected	-
7	PWR	Power input, 10.5 V–28 V	In
8	AUX_ON	RS232, manual PWR switch	In

Ports at the instrument front panel

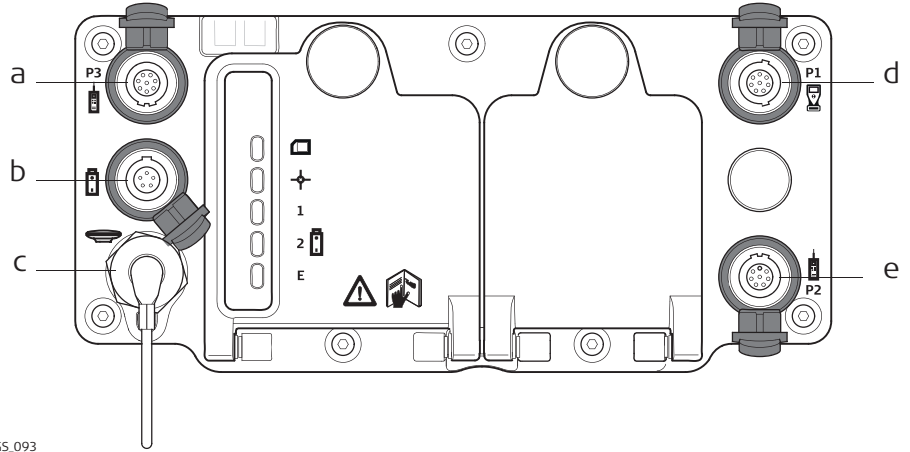

GS.093

- a P3: Power out, data in/out or remote interface in/out. 8 pin LEMO
- b Port PWR: Power in. 5 pin LEMO
- c Port ANT: GNSS antenna in
- d Port P1: Field controller in/out or remote interface in/out. 8 pin LEMO
- e Port P2: Power out, data in/out or remote interface in/out. 8 pin LEMO

Pin assignments for port P1

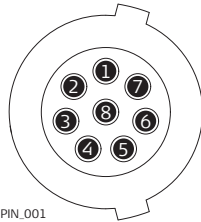

PIN_001

Pin	Signal Name	Function	Direction
1	USB_D+	USB data line	In or out
2	USB_D-	USB data line	In or out
3	GND	Signal ground	-
4	RxD	RS232, receive data	In
5	TxD	RS232, transmit data	Out
6	ID	Identification pin	In or out
7	PWR	Power input, 10.5 V-28 V	In
8	TRM_ON/ USB_ID	RS232, general-purpose signal	In or out

Pin assignments for port P2, and port P3

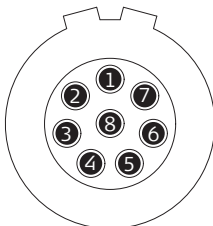

PIN_003

Pin	Signal Name	Function	Direction
1	RTS	RS232, ready to send	Out
2	CTS	RS232, clear to send	In
3	GND	Signal ground	-
4	RxD	RS232, receive data	In
5	TxD	RS232, transmit data	Out
6	ID	Identification pin	In
7	GPIO	RS232, configurable function	In or out
8	+12 V	12 V power supply out	Out

Pin assignments for port PWR

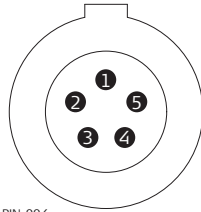

PIN_004

Pin	Signal Name	Function	Direction
1	PWR1	Power input, 11 V-28 V	In
2	ID1	Identification pin	In
3	GND	Signal ground	-
4	PWR2	Power input, 11 V-28 V	In
5	ID2	Identification pin	In

C.3

GS14/GS16

Ports at the instrument underside

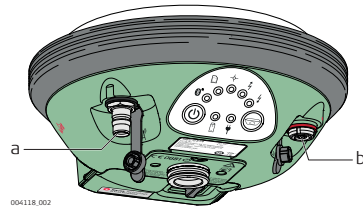

004118_002

- a QN-connector, only for models with UHF radio
- b Port 1 (USB and serial)

Pin assignments for port P1

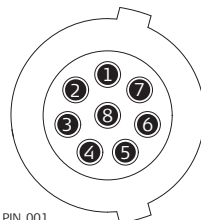

PIN_001

Pin	Signal Name	Function	Direction
1	USB_D+	USB data line	In or out

Pin	Signal Name	Function	Direction
2	USB_D-	USB data line	In or out
3	GND	Signal ground	-
4	RxD	RS232, receive data	In
5	TxD	RS232, transmit data	Out
6	ID	Identification pin	In or out
7	PWR	Power input, 10.5 V-28 V	In
8	GPIO	RS232, general-purpose signal	In or out

C.4

GS15

Ports at the instrument underside



0012261 001

- a QN-connector
- b Port 2
- c Port 1 (USB and serial)
- d Port 3

Pin assignments for port P1

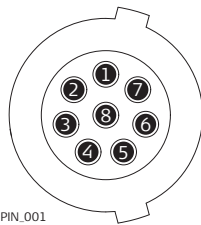

PIN_001

Pin	Signal Name	Function	Direction
1	USB_D+	USB data line	In or out
2	USB_D-	USB data line	In or out
3	GND	Signal ground	-
4	RxD	RS232, receive data	In
5	TxD	RS232, transmit data	Out
6	ID	Identification pin	In or out
7	PWR	Power input, 10.5 V-28 V	In
8	TRM_ON/ USB_ID	RS232, general-purpose signal	In or out

Pin assignments for port P2

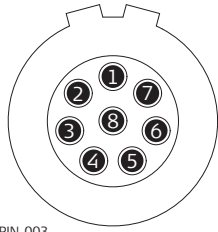

PIN_003

Pin	Signal Name	Function	Direction
1	RTS	RS232, ready to send	Out
2	CTS	RS232, clear to send	In
3	GND	Signal ground	-
4	RxD	RS232, receive data	In
5	TxD	RS232, transmit data	Out
6	ID	Identification pin	In
7	GPIO	RS232, configurable function	In or out
8	+12 V	12 V power supply out	Out

Pin assignments for port P3

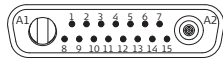

PIN_005

Pin	Signal Name	Function	Direction
1	PWR	4 V power supply in	In
2	Tx	Transmit data	In
3	Rx	Receive data	Out
4	GPO/DCD	General-purpose out, carrier detect out	Out
5	RTS	Request to send	In
6	CTS	Clear to send	Out
7	GPI/CFG	General-purpose in, config mode in	In
8	PWR	6 V power supply in	In
9	GPIO	General-purpose signal	In or out
10	GND	Signal and chassis ground	-
11	USB+	USB data line (+)	In or out
12	USB-	USB data line (-)	In or out
13	GND	Signal and chassis ground	-
14	ID	Identification pin	In or out
15	GPIO	General-purpose signal	In or out
A1	NC	Not used	-
A2	RF1	Antenna port, radio to antenna	-

C.5

GS18

Description

Some applications require knowledge of the pin assignments for the instrument ports.

In this chapter, the pin assignments and sockets for the instrument ports are explained.

Ports at the instrument underside



- a SMB-connector for external UHF antenna, only for models with UHF radio
- b SMB-connector for external LTE antenna
- c Port 1 (Power, USB and serial)

Pin assignments for port P1

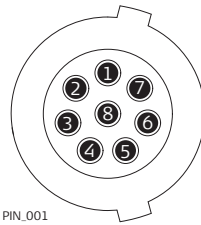

Pin	Signal Name	Function	Direction
1	USB_D+	USB data line	In or out
2	USB_D-	USB data line	In or out
3	GND	Signal ground	-
4	RxD	RS232, receive data	In
5	TxD	RS232, transmit data	Out
6	ID	Identification pin	In or out
7	PWR	Power input, 10.5 V-28 V	In
8	GPIO	RS232, general-purpose signal	In or out

C.6

GS25

Ports at the instrument back panel

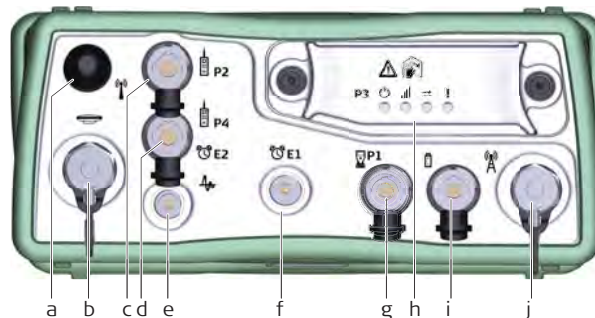

- a Port BT: Bluetooth antenna
- b Port ANT: GNSS antenna in
- c Port P2: Power out, data in/out or remote interface in/out. 8 pin LEMO
- d Port P4 and E2: Serial/Event port. 8 pin LEMO
- e Port PPS: Puls per second output
- f Port E1: Event 1
- g Port P1: CS field controller in/out or remote interface in/out. 8 pin LEMO
- h Port 3: Communication slot-in port and LEDs
- i Port PWR: Power in. 5 pin LEMO
- j Communication Slot-in port, Antenna, TNC

Pin assignments for port P1

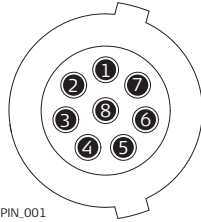

PIN_001

Pin	Signal Name	Function	Direction
1	USB_D+	USB data line	In or out
2	USB_D-	USB data line	In or out
3	GND	Signal ground	-
4	RxD	RS232, receive data	In
5	TxD	RS232, transmit data	Out
6	ID	Identification pin	In or out
7	PWR	Power input, 10.5 V-28 V	In
8	TRM_ON/ USB_ID	RS232, general-purpose signal	In or out

Pin assignments for port P2

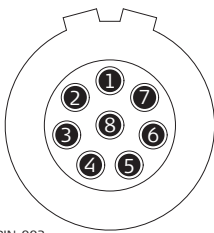

PIN_003

Pin	Signal Name	Function	Direction
1	RTS	RS232, ready to send	Out
2	CTS	RS232, clear to send	In
3	GND	Signal ground	-
4	RxD	RS232, receive data	In
5	TxD	RS232, transmit data	Out
6	ID	Identification pin	In

Pin	Signal Name	Function	Direction
7	GPIO	RS232, configurable function	In or out
8	+12 V	12 V power supply out	Out

Pin assignments for port P3

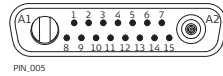

Pin	Signal Name	Function	Direction
1	PWR	4 V power supply in	In
2	Tx	Transmit data	In
3	Rx	Receive data	Out
4	GPO/DCD	General-purpose out, carrier detect out	Out
5	RTS	Request to send	In
6	CTS	Clear to send	Out
7	GPI/CFG	General-purpose in, config mode in	In
8	PWR	6 V power supply in	In
9	GPIO	General-purpose signal	In or out
10	GND	Signal and chassis ground	-
11	USB+	USB data line (+)	In or out
12	USB-	USB data line (-)	In or out
13	GND	Signal and chassis ground	-
14	ID	Identification pin	In or out
15	GPIO	General-purpose signal	In or out
A1	NC	Not used	-
A2	RF1	Antenna port, radio to antenna	-

Pin assignments for port P4/E2

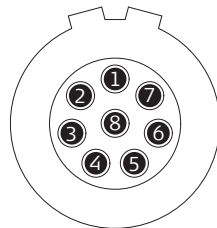

Pin	Signal Name	Function	Direction
1	RTS	RS232, ready to send	Out
2	CTS	RS232, clear to send	In
3	GND	Signal ground	-
4	RxD	RS232, receive data	In
5	TxD	RS232, transmit data	Out
6	ID	Identification pin	In or out

Pin	Signal Name	Function	Direction
7	GPIO/ EVT2 IN	RS232, general purpose input/output	In or out
8	+12 V	12 V power supply out	Out

Pin assignments for port PWR

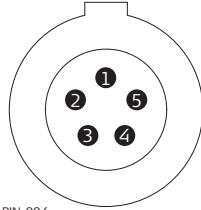

Pin	Signal Name	Function	Direction
1	PWR1	Power input, 11 V-28 V	In
2	ID1	Identification pin	In
3	GND	Signal ground	-
4	PWR2	Power input, 11 V-28 V	In
5	ID2	Identification pin	In

C.7

CS20

Ports at the instrument bottom panel - LEMO connector

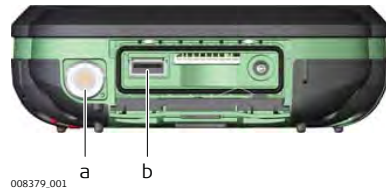

- a LEMO port (USB and serial)
- b USB A Host port

Pin assignments for 8 pin LEMO-1

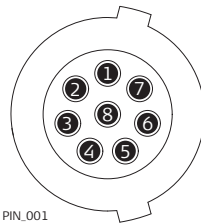

Pin	Signal Name	Function	Direction
1	USB_D+	USB data line	In or out
2	USB_D-	USB data line	In or out
3	GND	Signal ground	-
4	RxD	RS232, receive data	In
5	TxD	RS232, transmit data	Out
6	ID	Identification pin	In or out
7	PWR	Power input, 10.5 V-18 V	In

Pin	Signal Name	Function	Direction
8	GPIO	RS232, general purpose signal	In or out

C.8

TS16

Ports at the TS16 instrument

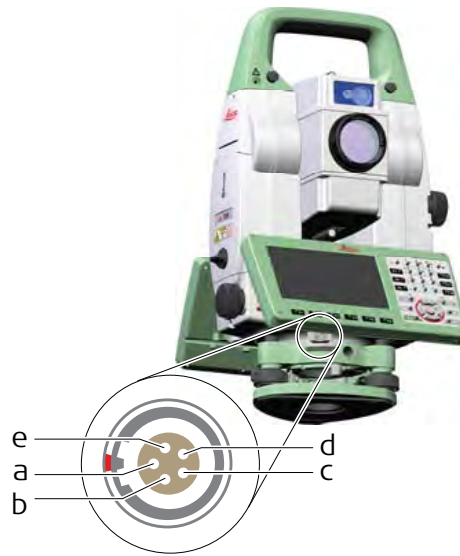

008363_001

a Port 1

Pin assignments for port P1

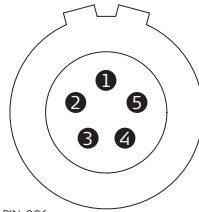

PIN_006

Pin	Signal Name	Function	Direction
1	PWR	Power input, + 12 V nominal (11 V - 16 V)	In
2	-	Not used	-
3	GND	Single ground	-
4	RxD	RS232, receive data	In
5	TxD	RS232, transmit data	Out

Ports at the MS60/
TS60 instrument



- a Pin 1
- b Pin 2
- c Pin 3
- d Pin 4
- e Pin 5
- f Pin 6
- g Pin 7
- h Pin 8

Pin assignments for
8 pin LEMO-1

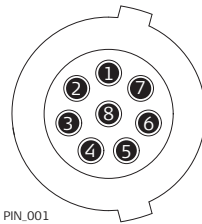

Pin	Signal Name	Function	Direction
1	USB_D+	USB data line	In or out
2	USB_D-	USB data line	In or out
3	GND	Signal ground	-
4	RxD	RS232, receive data	In
5	TxD	RS232, transmit data	Out
6	ID	Identification pin	In or out
7	PWR	Power input, nominal +12 V (11 V - 16 V)	In
8	NC	Not connected	-

Appendix D

Cables

D.1

GS Cables

Power cables

Name	Description
GEV97	<ul style="list-style-type: none">Allows GS10 (power port) to be externally poweredLEMO-1, 5 pin, 0° / LEMO-1, 5 pin, 0°1.8 m
GEV71	<ul style="list-style-type: none">Allows powering of any device from car battery.Crocodile clips / LEMO-1, 5 pin, 0° (female)4.0 m
GEV219	<ul style="list-style-type: none">Allows CS20 to be externally powered using the LEMO PortAllows GS10/GS14/GS15/GS16/GS15/GS18 (port 1) to be externally poweredLEMO-1, 8 pin, 135° / LEMO-1, 5 pin, 0°1.8 m
GEV276	<ul style="list-style-type: none">Allows CS20 to be externally powered using the power jackWall adapter / 5.5 mm barrel connector1.5 m

Y cables

Name	Description
GEV205	<ul style="list-style-type: none">Allows connections between GS10/GS15 (port 1), an external radio in GFU housing and the GEB371, with GS10/GS15 and a radio being externally poweredLEMO-1, 8 pin, 135° / LEMO-1, 8 pin, 135° (female) / LEMO-1, 5 pin, 0°1.8 m
GEV215	<ul style="list-style-type: none">Allows connections between CS20, the GS10/GS15 (port 1) and the GEB371, with the GS10/GS15 being powered from the GEB371.LEMO-1, 8 pin, 135° / LEMO-1, 5 pin, 30° / LEMO-1, 5 pin, 0°2.0 m
GEV243	<ul style="list-style-type: none">Allows GS10 (power port) to be externally powered from two external batteriesLEMO-1, 5 pin, 0° / LEMO-1, 5 pin, 0° / LEMO-1, 5 pin, 0°2.8 m
GEV261	<ul style="list-style-type: none">Allows a GS14/GS16/GS18 radio to be programmed by a computer.LEMO-1, 8 pin, 135° / LEMO-1, 5 pin, 0° / USB Type A / RS232 serial, 9 pin1.8 m

Radio programming cables

Name	Description
GEV231	<ul style="list-style-type: none">Allows an "SLR" radio device to be externally powered and programmed by a computer15 pin (GS15 slot-in port) (female) / RS232 serial, 9 pin / LEMO-1, 5 pin, 0°1.8 m

Name	Description
GEV171	<ul style="list-style-type: none"> Allows a radio within a GFU housing to be externally powered and programmed by a computer LEMO-1, 8 pin, 135° (female) / RS232 serial, 9 pin / LEMO-1, 5 pin, 0° 1.8 m

Radio cables

Name	Description
GEV232	<ul style="list-style-type: none"> Allows GFU housings to be connected to a GS10 (port 2 and 3), or GS15 (port 2) LEMO-1, 8 pin, 30° / LEMO-1, 8 pin, 30° (female) 2.8 m
GEV233	<ul style="list-style-type: none"> Allows GFU housings to be connected to a GS10 (port 2 and 3), or GS15 (port 2) LEMO-1, 8 pin, 30° / LEMO-1, 8 pin, 30° (female) 0.8 m

Serial data transfer cables

Name	Description
GEV160	<ul style="list-style-type: none"> Allows serial connection between GS10 (port 2 and 3), or GS15 (port 2) to a computer to stream NMEA or RTK data LEMO-1, 8 pin, 30° / RS232 serial, 9 pin 2.8 m
GEV162	<ul style="list-style-type: none"> Allows serial connection between GS10/GS15 (port 1) to a computer to stream NMEA or RTK data Allows serial connection between CS20 (LEMO port) and, for example, a hidden point device, ASCII input device, or computer. LEMO-1, 8 pin, 135° / RS232 serial, 9 pin 2.8 m
GEV163	<ul style="list-style-type: none"> Allows serial connection between CS20 and GS10/GS15 port 1. This connection is useful when using third-party software on the CS20 and a cable connection is required to the GS10/GS15. Allows serial connection between CS20 and GS10/GS15 (port 1). This connection is useful when using third-party software on the CS20 and a cable connection is required to the GS10/GS15. LEMO-1, 8 pin, 30° / LEMO-1, 8 pin, 135° 1.8 m

USB to serial converter cables

Name	Description
GEV268	<ul style="list-style-type: none"> Allows GS10 (port 2 and 3) or GS15 (port 2) to be connected to a computer where a serial connection is required, but no 9 pin RS232 port physically exists on the computer. This cable allows a serial connection through the USB port of the computer to the GS10/GS15 hardware. LEMO-1, 8 pin, 30° / USB type A 2.0 m

Name	Description
GEV269	<ul style="list-style-type: none"> Allows CS20 and GS10/GS14/GS15/GS16/GS18 (port 1) to be connected to a computer where a serial connection is required, but no 9 pin RS232 port physically exists on the computer. This cable allows a serial connection through the USB port of the computer to the CS20 or GS10/GS14/GS15/GS16/GS18 hardware. LEMO-1, 8 pin, 135° / USB type A 2.0 m

USB data transfer cables

Name	Description
GEV234	<ul style="list-style-type: none"> Allows a CS20 to connect to a GS10/GS15 (port 1). This cable should be used if a cable connection is needed between CS20 and GS10/GS15. Allows a USB connection between the USB port of a computer and the GS10/GS15 (port 1) Allows a USB connection between the USB port of a computer and the CS20 LEMO port LEMO-1, 8 pin, 135° / USB type A 1.65 m
GEV237	<ul style="list-style-type: none"> Allows a CS20 to connect to a GS10/GS15 (port 1). This cable should be used if a cable connection is needed between CS20 and GS10/GS15. LEMO-1, 8 pin, 135° / LEMO-1, 8 pin, 135° 1.65 m

Antenna cables

Name	Description
GEV108	<ul style="list-style-type: none"> TNC connector / TNC connector 30 m
GEV119	<ul style="list-style-type: none"> TNC connector / TNC connector 10 m
GEV120	<ul style="list-style-type: none"> TNC connector / TNC connector 2.8 m
GEV134	<ul style="list-style-type: none"> TNC connector / TNC connector 50 m
GEV141	<ul style="list-style-type: none"> TNC connector / TNC connector 1.2 m
GEV142	<ul style="list-style-type: none"> TNC connector / TNC connector (male) 1.6 m
-	<ul style="list-style-type: none"> TNC connector / TNC connector 70 m

D.2

TS Cables

Power cables

Name	Description
GEV52	<ul style="list-style-type: none"> Allows TS12/TS15/TS16 to be externally powered LEMO-0, 5 pin, 30° / LEMO-1, 5 pin, 30° 1.8 m

Name	Description
GEV219	<ul style="list-style-type: none"> Allows CS20 to be externally powered using the LEMO port Allows GS10/GS15 (port 1) to be externally powered Allows MS50/TS50/TM50/TS60/MS60 to be externally powered LEMO-1, 8 pin, 135° / LEMO-1, 5 pin, 30° 1.8 m

Radio / Y cables

Name	Description
GEV186	<ul style="list-style-type: none"> Allows connections between TS12/TS15/TS16, an external battery and TCPS LEMO-0, 5 pin, 30° / LEMO-0, 8 pin, 30° / LEMO-1, 5 pin 1.8 m
GEV220	<ul style="list-style-type: none"> Allows connections between MS50/TS50/TM50/TS60/MS60, external battery and a computer with 9 pin D-Sub RS232. LEMO-1, 8 pin, 135° / LEMO-1, 5 pin / 9 pin D-Sub RS232 1.8 m
GEV236	<ul style="list-style-type: none"> Allows connection between MS50/TS50/TM50/TS60/MS60, an external battery and TCPS LEMO-1, 8 pin, 15/150° / LEMO-1, 5 pin / LEMO-1, 8 pin, 30° 1.8 m
GEV261	<ul style="list-style-type: none"> Allows connections between MS50/TS50/TM50/TS60/MS60, external battery and a computer with either USB or 9 pin D-Sub RS232. LEMO-1, 8 pin, 135° / LEMO-1, 5 pin / USB / 9 pin D-Sub RS232 1.8 m

Serial data transfer cables

Name	Description
GEV102	<ul style="list-style-type: none"> Allows serial connection between TS12/TS15/TS16 and a computer Allows serial connection between TS12/TS15/TS16 and CS20 (with 9 pin serial CBC02 connector module) LEMO-0, 5 pin, 30° / 9 pin D-Sub RS232 2.0 m
GEV162	<ul style="list-style-type: none"> Allows serial connection between CS20 and a computer Allows serial connection between MS50/TS50/TM50/TS60/MS60 and a computer LEMO-1, 8 pin, 135° / 9 pin D-Sub RS232 2.8 m
GEV163	<ul style="list-style-type: none"> Allows serial connection between CS20 and GS10/GS15 port 1. This connection is useful when using third-party software on the CS20 and a cable connection is required to the GS10/GS15. Serial data cable for communication between MS50/TS50/TM50/TS60/MS60 and CS20, connects LEMO 8 pin with LEMO 8 pin. LEMO-1, 8 pin, 30° / LEMO-1, 8 pin, 135° 1.8 m

Name	Description
GEV187	<ul style="list-style-type: none"> Allows connections between TS12/TS15/TS16, an external battery and a computer LEMO-0, 5 pin, 30° / 9 pin D-Sub RS232 / LEMO-1, 5 pin, 30° 2.0 m
GEV217	<ul style="list-style-type: none"> Allows serial connection between TS12/TS15/TS16 and CS20 LEMO-1, 8 pin, 135° / LEMO-0, 5 pin, 30° 1.8 m

USB to serial converter cables

Name	Description
GEV267	<ul style="list-style-type: none"> Allows TS12/TS15/TS16 to be connected to a computer where a serial connection is required, but no 9 pin D-Sub RS232 port physically exists on the computer. This cable allows a serial connection through the USB port of the computer. LEMO-0, 5 pin, 30° / USB type A 2.0 m

USB data transfer cables

Name	Description
GEV234	<ul style="list-style-type: none"> Allows a USB connection between the USB port of a computer and the CS20 or TM50/TS60/MS60. LEMO-1, 8 pin, 135° / USB type A 1.65 m
GEV237	<ul style="list-style-type: none"> USB data cable for communication between MS50/TS50/TM50/TS60/MS60 and CS. LEMO-1, 8 pin, 135° / LEMO-1, 8 pin, 135° 1.65 m

Appendix E NMEA Message Formats

E.1 Overview

Description

National Marine Electronics Association is a standard for interfacing marine electronic devices. This chapter describes all NMEA-0183 messages which can be output by the instrument.

Access

Step	Description
1.	Select Leica Captivate - Home: Settings\Connections\All other connections\NMEA 1 or NMEA 2 .
2.	Press Edit .
3.	Check Stream NMEA messages from the GS sensor .
4.	Press Messages .



A Talker ID appears at the beginning of the header of each NMEA message. The Talker ID can be user defined or standard (based on the NMEA 3.0). The standard is normally GP for GPS but can be changed in **NMEA Output 1** or **NMEA Output 2**.

E.2 Symbols Used for Describing the NMEA Formats

Description

NMEA messages consist of various fields. The fields are:

- Header
- Special format fields
- Numeric value fields
- Information fields
- Null fields

Certain symbols are used as identifier for the field types. These symbols are described in this section.

Header

Symbol	Field	Description	Example
\$	-	Start of sentence	\$
--ccc	Address	<ul style="list-style-type: none">• -- = alphanumeric characters identifying the talker Options: GN = Global Navigation Satellite System GP = GPS only GL = GLONASS GA = Galileo BD = BeiDou	GNGGA GPGGA GLGGA GAGGA BDGGA

Symbol	Field	Description	Example
		<ul style="list-style-type: none"> ccc = alphanumeric characters identifying the data type and string format of the successive fields. Usually the name of the message. 	

Special format fields

Symbol	Field	Description	Example
A	Status	<ul style="list-style-type: none"> A = Yes, Data Valid, Warning Flag Clear V = No, Data Invalid, Warning Flag Set 	V
lll.ll	Latitude	<ul style="list-style-type: none"> Degreesminutes.decimal Two fixed digits of degrees, two fixed digits of minutes and a variable number of digits for decimal fraction of minutes. Leading zeros are always included for degrees and minutes to maintain fixed length. 	4724.538950
yyyyy.yy	Longitude	<ul style="list-style-type: none"> Degreesminutes.decimal Three fixed digits of degrees, two fixed digits of minutes and a variable number of digits for decimal fraction of minutes. Leading zeros are always included for degrees and minutes to maintain fixed length. 	00937.046785
eeeeee.eee	Grid Easting	At the most six fixed digits for metres and three fixed digits for decimal fractions of metres.	195233.507
nnnnnn.nnn	Grid Northing	At the most six fixed digits for metres and three fixed digits for decimal fractions of metres.	127223.793
hhmmss.ss	Time	<ul style="list-style-type: none"> hoursminutesseconds.decimal Two fixed digits of hours, two fixed digits of minutes, two fixed digits of seconds and a variable number of digits for decimal fraction of seconds. 	115744.00

Symbol	Field	Description	Example
		<ul style="list-style-type: none"> Leading zeros are always included for hours, minutes and seconds to maintain fixed length. 	
mmddy	Date	<ul style="list-style-type: none"> Monthdayyear - two fixed digits of month, two fixed digits of day, two fixed digits of year. Leading zeros always included for month, day and year to maintain fixed length. 	093003
No specific symbol	Defined field	<ul style="list-style-type: none"> Some fields are specified to contain predefined constants, most often alpha characters. Such a field is indicated by the presence of one or more valid characters. Excluded from the list of valid characters are the following that are used to indicate other field types: A, a, c, x, hh, hhmss.ss, lll.ll, yyyyy.yy. 	M

Numeric value fields

Symbol	Field	Description	Example
x.x	Variable numbers	<ul style="list-style-type: none"> Integer or floating numeric field Optional leading and trailing zeros. Decimal point and associated decimal-fraction are optional if full resolution is not required. 	73.10 = 73.1 = 073.1 = 73
hh_	Fixed HEX field	Fixed length HEX numbers	3F

Information fields

Symbol	Field	Description	Example
c--c	Variable text	Variable length valid character field	A
aa_	Fixed alpha field	Fixed length field of upper case or lower case alpha characters	N
xx_	Fixed number field	Fixed length field of numeric characters	1

Null fields

Symbol	Field	Description	Example
No symbol	Information unavailable for output	Null fields do not contain any information.	,,



Fields are always separated by a comma. Before the Checksum field there is never a comma.



When information for a field is not available, the position in the data string is empty.

E.3

GGA - Global Positioning System Fix Data

Syntax

```
$--GGA,hhmmss.ss,llll.ll,a,yyyy.yy,a,x,xx,x.x,x.x,M,x.x,M,x.x,xxxx*hh<CR><LF>
```

Description of fields

Field	Description
\$--GGA	Header including Talker ID
hhmmss.ss	UTC time of position
llll.ll	Latitude (WGS 1984)
a	Hemisphere, N orth or S outh
yyyy.yy	Longitude (WGS 1984)
a	E ast or W est
x	Position quality indicator 0 = Fix not available or invalid 1 = No real-time position, navigation fix 2 = Real-time position, ambiguities not fixed 3 = Valid fix for GNSS P recise P ositioning S ervice mode, for example WAAS 4 = Real-time position, ambiguities fixed
xx	Number of satellites in use. For \$GNGGA messages: The combined GPS, GLONASS, Galileo and BeiDou satellites used in the position.
x.x	HDOP
x.x	Altitude of position marker above/below mean sea level in metres. If no orthometric height is available the local ellipsoidal height will be exported. If the local ellipsoidal height is not available either, the WGS 1984 ellipsoidal height will be exported.
M	Units of altitude as fixed text M
x.x	Geoidal separation in metres. The Geoidal separation is the difference between the WGS 1984 earth ellipsoid surface and mean sea level.
M	Units of geoidal separation as fixed text M
x.x	Age of differential GNSS data, empty when DGPS not used
xxxx	Differential base station ID, 0000 to 1023

Field	Description
*hh	Checksum
<CR>	Carriage Return
<LF>	Line Feed

Examples

For NMEA v4.0 and v4.1:

Standard Talker ID = GPS only

```
$GPGGA,141909.00,4724.5294609,N,00937.0836236,E,1,09,1.0,366.745,M,100.144,M,,*52
```

Standard Talker ID = GNSS

```
$GNGGA,142309.00,4724.5296834,N,00937.0832766,E,1,16,0.7,366.740,M,100.144,M,,*4E
```

E.4

GGK - Real-Time Position with DOP

Syntax

```
$--GGK,hhmmss.ss,mmddy,lll.ll,a,yyyy.yy,a,x,xx,x.x,EHTx.x,M*hh<CR><LF>
```

Description of fields

Field	Description
\$--GGK	Header including Talker ID
hhmmss.ss	UTC time of position
mmddy	UTC date
lll.ll	Latitude (WGS 1984)
a	Hemisphere, N orth or S outh
yyyy.yy	Longitude (WGS 1984)
a	E ast or W est
x	Position quality indicator 0 = Fix not available or invalid 1 = No real-time position, navigation fix 2 = Real-time position, ambiguities not fixed 3 = Real-time position, ambiguities fixed 5 = Real-time position, float
xx	Number of satellites in use. For \$GNGGK messages: The combined GPS, GLONASS, Galileo and BeiDou satellites used in the position.
x.x	GDOP
EHT	Ellipsoidal height
x.x	Altitude of position marker as local ellipsoidal height. If the local ellipsoidal height is not available, the WGS 1984 ellipsoidal height will be exported.
M	Units of altitude as fixed text M
*hh	Checksum
<CR>	Carriage Return

Field	Description
<LF>	Line Feed

Examples

For NMEA v4.0 and v4.1:

Standard Talker ID = GPS only

```
$GPGGK,142804.00,111414,4724.5292267,N,00937.0832394,E,1,09,2.3,EHT466.919,M*46
```

Standard Talker ID = GNSS

```
$GNGGK,142629.00,111414,4724.5295910,N,00937.0831490,E,1,16,1.6,EHT467.089,M*5C
```

E.5

GGK(PT) - Real-Time Position with DOP, Trimble Proprietary

Syntax

```
$PTNL,GGK,hhmmss.ss,mmddy,lll.l, a,yyyyy.yy,a,x,xx,x.x,EHTx.x,M*hh<CR><LF>
```

Description of fields

Field	Description
\$PTNL	\$ = Start of sentence delimiter, talker ID fixed with PTNL
GGK	GGK sentence formatter
hhmmss.ss	UTC time of position
mmddy	UTC date
lll.l	Latitude (WGS 1984)
a	Hemisphere, N orth or S outh
yyyyy.yy	Longitude (WGS 1984)
a	E ast or W est
x	Position quality indicator 0 = Fix not available or invalid 1 = No real-time position, navigation fix 2 = Not existing 3 = Real-time position, ambiguities fixed 4 = Real-time position, ambiguities not fixed
xx	Number of satellites in use, 00 to 26.
x.x	PDOP
EHT	Ellipsoidal height
x.x	Altitude of position marker as local ellipsoidal height. If the local ellipsoidal height is not available, the WGS 1984 ellipsoidal height will be exported.
M	Units of altitude as fixed text M
*hh	Checksum
<CR>	C arriage R eturn
<LF>	L ine F eed

Examples

For NMEA v4.0 and v4.1:

Standard Talker ID = GPS only

```
$PTNL,GGK,143504.00,111414,4724.5291450,N,00937.0834387,E,  
1,10,1.6,EHT467.275,M*7C
```

Standard Talker ID = GNSS

```
$PTNL,GGK,143619.00,111414,4724.5293608,N,00937.0832640,E,  
1,17,1.3,EHT467.733,M*73
```

E.6

GGQ - Real-Time Position with CQ

Syntax

```
$--GGQ,hhmmss.ss,mmddyy,llll.ll,a,yyyyy.yy,a,x,xx,x.x,x.x,M*hh<CR><LF>
```

Description of fields

Field	Description
\$--GGQ	Header including talker ID
hhmmss.ss	UTC time of position
mmddyy	UTC date
llll.ll	Latitude (WGS 1984)
a	Hemisphere, N orth or S outh
yyyyy.yy	Longitude (WGS 1984)
a	E ast or W est
x	Position quality indicator 0 = Fix not available or invalid 1 = No real-time position, navigation fix 2 = Real-time position, ambiguities not fixed 3 = Real-time position, ambiguities fixed 5 = Real-time position, float
xx	Number of satellites in use. For \$GNGGQ messages: The combined GPS, GLONASS, Galileo and BeiDou satellites used in the position.
x.x	Coordinate quality in metres
x.x	Altitude of position marker above/below mean sea level in metres. If no orthometric height is available the local ellipsoidal height will be exported. If the local ellipsoidal height is not available either, the WGS 1984 ellipsoidal height will be exported.
M	Units of altitude as fixed text M
*hh	Checksum
<CR>	C arriage R eturn
<LF>	L ine F eed

Examples

For NMEA v4.0:

Standard Talker ID = GPS only

```
$GPGGQ,144419.00,111414,4724.5290370,N,00937.0833037,E,  
1,10,3.894,366.261,M*01
```

Standard Talker ID = GNSS

```
$GNGGQ,144054.00,111414,4724.5294512,N,00937.0834677,E,  
1,21,3.679,366.584,M*12  
$GPGGQ,144054.00,111414,,,,,10,,,*45  
$GLGGQ,144054.00,111414,,,,,07,,,*5F  
$BDGGQ,144054.00,111414,,,,,04,,,*51
```

For NMEA v4.1:

Standard Talker ID = GPS only

```
$GPGGQ,144339.00,111414,4724.5290715,N,00937.0833826,E,  
1,10,4.060,366.339,M*03
```

Standard Talker ID = GNSS

```
$GNGGQ,144224.00,111414,4724.5293821,N,00937.0835717,E,  
1,22,3.673,366.944,M*12
```



When more than one GNSS is active only \$GNGGQ is output.

E.7

GLL - Geographic Position Latitude/Longitude

Syntax

```
$--GLL,III.II,a,yyyy.yy,a,hmmss.ss,A,a*hh<CR><LF>
```

Description of fields

Field	Description
\$--GLL	Header including talker ID
III.II	Latitude (WGS 1984)
a	Hemisphere, N orth or S outh
yyyy.yy	Longitude (WGS 1984)
a	E ast or W est
hmmss.ss	UTC time of position
A	Status A = Data valid V = Data not valid
a	Mode indicator A = Autonomous mode D = Differential mode N = Data not valid
*hh	Checksum
<CR>	C arriage R eturn

Field	Description
<LF>	Line Feed



The Mode indicator field supplements the Status field. The Status field is set to A for the Mode indicators A and D. The Status field is set to V for the Mode indicator N.

Examples

For NMEA v4.0 and v4.1:

Standard Talker ID = GPS only

```
$GPGLL,4724.5289712,N,00937.0834834,E,144659.00,A,A*68
```

Standard Talker ID = GNSS

```
$GNGLL,4724.5294325,N,00937.0836915,E,144839.00,A,A*72
```

E.8

GNS - GNSS Fix Data

Syntax

```
$--GNS,hhmmss.ss,llll.ll,a,yyyyy.yy,a,c--c,xx,x.x,x.x,x.x,x.x,xxx,h*hh<CR><LF>
```

Description of fields

Field	Description
\$--GNS	Header including talker ID
hhmmss.ss	UTC time of position
llll.ll	Latitude (WGS 1984)
a	Hemisphere, N orth or S outh
yyyyy.yy	Longitude (WGS 1984)
a	E ast or W est
c--c	Four character mode indicator for each GNSS constellation used in the position where the <ul style="list-style-type: none"> • First character is for GPS • Second character is for GLONASS • Third character is for Galileo • Fourth character is for BeiDou N = Satellite system not used in position fix or fix not valid P = Precise, for example no deliberate degradation such as SA A = Autonomous; navigation fix, no real-time fix D = Differential; real-time position, ambiguities not fixed R = Real-time kinematic; ambiguities fixed F = Float real-time kinematic
xx	Number of satellites in use. For \$GNNGGA messages: The combined GPS, GLONASS, Galileo and BeiDou satellites used in the position.
x.x	HDOP

Field	Description
x.x	Altitude of position marker above/below mean sea level in metres. If no orthometric height is available the local ellipsoidal height is exported. If the local ellipsoidal height is not available either, the WGS 1984 ellipsoidal height is exported.
x.x	Geoidal separation in metres
x.x	Age of differential data
xxxx	Differential base station ID, 0000 to 1023
h	For NMEA v4.1. Navigation Status Indicator S = Safe C = Caution U = Unstable V = Navigation status not valid
*hh	Checksum
<CR>	Carriage Return
<LF>	Line Feed

Examples

For NMEA v4.0:

Standard Talker ID = GPS only

```
$GPGNS,150254.00,4724.5290110,N,00937.0837286,E,A,10,0.8,366.282,100.143,,*33GNSS
```

Standard Talker ID = GNSS

```
$GNGNS,145309.00,4724.5293077,N,00937.0838953,E,AANA,22,0.5,367.326,100.144,,*64
```

 When more than one GNSS is active only \$GNGNS is output.

For NMEA v4.1:

Standard Talker ID = GPS only

```
$GPGNS,150219.00,4724.5290237,N,00937.0837225,E,A,10,0.8,366.329,100.143,,,V*4FGNSS
```

Standard Talker ID = GNSS

```
$GNGNS,145339.00,4724.5292786,N,00937.0838968,E,AANA,22,0.5,367.334,100.143,,,V*19
```

 When more than one GNSS is active only \$GNGNS is output.

E.9

GSA - GNSS DOP and Active Satellites

Syntax

```
$--GSA,a,x,xx,xx,xx,xx,xx,xx,xx,xx,xx,xx,xx,x,x,x,x,h*hh<CR><LF>
```

Description of fields

Field	Description
\$--GSA	Header including talker ID

Field	Description																																				
a	Mode M = Manual, forced to operate in 2D or 3D mode A = Automatic, allowed to change automatically between 2D and 3D																																				
x	Mode 1 = Fix not available 2 = 2D 3 = 3D																																				
xx	PRN numbers of the satellites used in the solution. For NMEA v4.0: This field is repeated 12 times. For NMEA v4.1: This field is repeated 16 times.  A new GSA message is sent for each GNSS constellation tracked. For NMEA v4.0 and v4.1: <table border="0"> <tr> <td>GPS</td> <td>1 to 32</td> <td>GPS satellites</td> </tr> <tr> <td></td> <td>33 to 64</td> <td>SBAS satellites</td> </tr> <tr> <td></td> <td>65 to 99</td> <td>Undefined</td> </tr> <tr> <td>GLONASS</td> <td>1 to 32</td> <td>Undefined</td> </tr> <tr> <td></td> <td>33 to 64</td> <td>SBAS satellites</td> </tr> <tr> <td></td> <td>65 to 99</td> <td>GLONASS satellites</td> </tr> </table> For NMEA v4.1 also: <table border="0"> <tr> <td>Galileo</td> <td>1 to 36</td> <td>Galileo satellites</td> </tr> <tr> <td></td> <td>37 to 64</td> <td>Galileo SBAS</td> </tr> <tr> <td></td> <td>65 to 99</td> <td>Undefined</td> </tr> <tr> <td>BeiDou</td> <td>1 to 37</td> <td>BeiDou satellites</td> </tr> <tr> <td></td> <td>38 to 64</td> <td>BeiDou SBAS</td> </tr> <tr> <td></td> <td>65 to 99</td> <td>Undefined</td> </tr> </table>	GPS	1 to 32	GPS satellites		33 to 64	SBAS satellites		65 to 99	Undefined	GLONASS	1 to 32	Undefined		33 to 64	SBAS satellites		65 to 99	GLONASS satellites	Galileo	1 to 36	Galileo satellites		37 to 64	Galileo SBAS		65 to 99	Undefined	BeiDou	1 to 37	BeiDou satellites		38 to 64	BeiDou SBAS		65 to 99	Undefined
GPS	1 to 32	GPS satellites																																			
	33 to 64	SBAS satellites																																			
	65 to 99	Undefined																																			
GLONASS	1 to 32	Undefined																																			
	33 to 64	SBAS satellites																																			
	65 to 99	GLONASS satellites																																			
Galileo	1 to 36	Galileo satellites																																			
	37 to 64	Galileo SBAS																																			
	65 to 99	Undefined																																			
BeiDou	1 to 37	BeiDou satellites																																			
	38 to 64	BeiDou SBAS																																			
	65 to 99	Undefined																																			
x.x	PDOP																																				
x.x	HDOP																																				
x.x	VDOP																																				
h	For NMEA v4.1. GNSS System ID 1 = GPS 2 = GLONASS 3 = Galileo 4 = BeiDou																																				
*hh	Checksum																																				
<CR>	Carriage Return																																				
<LF>	Line Feed																																				

Examples

For NMEA v4.0:

Standard Talker ID = GPS only

```
$GPGSA,A,3,01,04,06,09,11,17,20,23,31,,,,,1.5,0.8,1.3*31
```

Standard Talker ID = GNSS

```
$GNGSA,A,3,01,04,06,09,11,17,20,23,31,,,,,1.1,0.5,1.0*25
```

```
$GNGSA,A,3,65,71,72,73,74,80,86,87,88,,,,,1.1,0.5,1.0*26
```

For NMEA v4.1:

Standard Talker ID = GPS only

```
$GPGSA,A,3,01,04,06,09,11,17,20,23,31,,,,,,,,,1.5,0.8,1.3,1*2C
```

Standard Talker ID = GNSS

```
$GNGSA,A,3,01,04,06,09,11,17,20,23,31,,,,,,,,,1.1,0.5,1.0,1*38
```

```
$GNGSA,A,3,65,71,72,73,74,80,86,87,88,,,,,,,,,1.1,0.5,1.0,2*38
```

```
$GNGSA,A,3,05,07,10,11,,,,,,,,,,,,,1.1,0.5,1.0,4*33
```

E.10

GSV - GNSS Satellites in View

Syntax

```
$--GSV,x,x,xx,xx,xx,xxx,xx,.....,h*hh<CR><LF>
```

Description of fields

Field	Description		
\$--GSV	Header including talker ID		
x	Total number of messages, 1 to 9		
x	Message number, 1 to 9		
xx	Number of theoretically visible satellites according to the current almanac.		
xx	PRN numbers of the satellites used in the solution.		
	GPS	1 to 32	GPS satellites
		33 to 64	SBAS satellites
		65 to 99	Undefined
	GLONASS	1 to 32	Undefined
		33 to 64	SBAS satellites
		65 to 99	GLONASS satellites
	Galileo	1 to 36	Galileo satellites
		37 to 64	Galileo SBAS
		65 to 99	Undefined
	BeiDou	1 to 37	BeiDou satellites
		38 to 64	BeiDou SBAS
		65 to 99	Undefined
xx	Elevation in degrees, 90 maximum, empty when not tracking		

Field	Description		
xxx	Azimuth in degrees true north, 000 to 359, empty when not tracking		
xx	S ignal to N oise R ation C/No in dB, 00 to 99 of L1 signal, null field when not tracking.		
...	Repeat set PRN / Slot number, elevation, azimuth and SNR up to four times		
h	For NMEA v4.1. Signal ID		
	GPS	0	All signals
		1	L1 C/A
		2	L1 P(Y)
		3	L1M
		4	L2 P(Y)
		5	L2C-M
		6	L2C-L
		7	L5-I
		8	L5-Q
		9-F	Reserved
	GLONASS	0	All signals
		1	G1 C/A
		2	G1 P
		3	G2 C/A
		4	GLONASS (M) G2 P
		5-F	Reserved
	Galileo	0	All signals
		1	E5a
		2	E5b
		3	E5a+b
		4	E6-A
		5	E6-BC
		6	L1-A
		7	L1-BC
		8-F	Reserved
	BeiDou	0	All signals
		1-F	Reserved
*hh	Checksum		
<CR>	C arriage R eturn		
<LF>	L ine F eed		



Satellite information can require the transmission of multiple messages, specified by the total number of messages and the message number.



The fields for the PRN / Slot number, Elevation, Azimuth and SNR form one set. A variable number of these sets are allowed up to a maximum of four sets per message.

Examples

For NMEA v4.0:

Standard Talker ID = GPS only

```
$GPGSV,3,1,09,01,31,151,45,06,37,307,47,09,47,222,49,10,14,279,44*7D
$GPGSV,3,2,09,17,29,246,47,20,69,081,49,23,79,188,51,31,18,040,41*76
$GPGSV,3,3,09,32,23,087,42,,,,,,,,,,,,,*49
```

Standard Talker ID = GNSS

```
$GPGSV,3,1,09,01,34,150,47,06,34,308,47,09,44,220,48,10,11,277,43*7B
$GPGSV,3,2,09,17,31,248,49,20,71,076,48,23,76,192,50,31,19,042,42*7A
$GPGSV,3,3,09,32,25,085,40,,,,,,,,,,,,,*4F
$GLGSV,3,1,09,65,24,271,45,71,37,059,47,72,67,329,49,73,31,074,45*66
$GLGSV,3,2,09,74,17,127,44,80,15,022,41,86,12,190,44,87,49,239,48*66
$GLGSV,3,3,09,88,38,314,46,,,,,,,,,,,,,*53
$BDGSV,1,1,04,05,18,123,38,07,23,044,39,10,35,068,45,11,29,224,45*61
```

For NMEA v4.1:

Standard Talker ID = GPS only

```
$GPGSV,3,1,09,01,31,151,46,06,36,307,47,09,46,222,49,10,13,278,44,0*64
$GPGSV,3,2,09,17,29,246,48,20,69,080,49,23,79,189,51,31,18,040,42,0*66
$GPGSV,3,3,09,32,23,087,42,,,,,,,,,,,,,0*55
```

Standard Talker ID = GNSS

```
$GPGSV,3,1,09,01,32,151,46,06,35,308,47,09,45,221,49,10,12,278,42,0*6C
$GPGSV,3,2,09,17,30,247,47,20,70,078,49,23,77,191,51,31,19,041,41,0*6B
$GPGSV,3,3,09,32,24,086,41,,,,,,,,,,,,,0*50
$GLGSV,3,1,09,65,25,272,46,71,36,060,47,72,68,333,49,73,31,073,45,0*73
$GLGSV,3,2,09,74,18,126,47,80,15,021,38,86,11,190,45,87,48,238,50,0*71
$GLGSV,3,3,09,88,38,312,46,,,,,,,,,,,,,0*49
$BDGSV,1,1,04,05,18,123,38,07,23,044,40,10,35,067,45,11,28,224,46,0*7E
```

E.11

LLK - Leica Local Position and GDOP

Syntax

```
$--LLK,hhmmss.ss,mmddy,eeeeee.eee,M,nnnnnn.nnn,M,x,xx,x.x,x.x,M*hh
<CR><LF>
```

Description of fields

Field	Description
\$--LLK	Header including talker ID
hhmmss.ss	UTC time of position
mmddy	UTC date

Field	Description
eeeeee.eee	Grid Easting in metres
M	Units of grid Easting as fixed text M
nnnnnn.nnn	Grid Northing in metres
M	Units of grid Northing as fixed text M
x	Position quality 0 = Fix not available or invalid 1 = No real-time position, navigation fix 2 = Real-time position, ambiguities not fixed 3 = Real-time position, ambiguities fixed 5 = Real-time position, float
xx	Number of satellites in use. For \$GNLLK messages: The combined GPS, GLONASS, Galileo and BeiDou satellites used in the position.
x.x	GDOP
x.x	Altitude of position marker above/below mean sea level in metres. If no orthometric height is available the local ellipsoidal height will be exported.
M	Units of altitude as fixed text M
*hh	Checksum
<CR>	Carriage Return
<LF>	Line Feed

Examples

For NMEA v4.0:

Standard Talker ID = GPS only

```
$GPKLL,153254.00,111414,546628.909,M,5250781.888,M,1,09,1.8,366.582,M*15
```

Standard Talker ID = GNSS

```
$GNLLK,153819.00,111414,546629.154,M,5250782.866,M,1,20,1.3,367.427,M*05
```

```
$GPKLL,153819.00,111414,,,,,09,,, *50
```

```
$GLLLK,153819.00,111414,,,,,07,,, *42
```

```
$BDLLK,153819.00,111414,,,,,04,,, *4C
```

For NMEA v4.1:

Standard Talker ID = GPS only

```
$GPKLL,153254.00,111414,546628.909,M,5250781.888,M,1,09,1.8,366.582,M*15
```

Standard Talker ID = GNSS

\$GNLLK,153504.00,111414,546629.055,M,5250782.977,M,
1,20,1.3,367.607,M*05



When more than one GNSS is active only \$GNLLK is output.

E.12

LLQ - Leica Local Position and Quality

Syntax

\$--LLQ,hhmmss.ss,mmddyy,eeeeee.eee,M,nnnnnn.nnn,M,x,xx,x.x,x.x,M*hh
<CR><LF>

Description of fields

Field	Description
\$--LLQ	Header including talker ID
hhmmss.ss	UTC time of position
mmddyy	UTC date
eeeeee.eee	Grid Easting in metres
M	Units of grid Easting as fixed text M
nnnnnn.nnn	Grid Northing in metres
M	Units of grid Northing as fixed text M
x	Position quality 0 = Fix not available or invalid 1 = No real-time position, navigation fix 2 = Real-time position, ambiguities not fixed 3 = Real-time position, ambiguities fixed 5 = Real-time position, float
xx	Number of satellites in use. For \$GNLLQ messages: The combined GPS, GLONASS, Galileo and BeiDou satellites used in the position.
x.x	Coordinate quality in metres
x.x	Altitude of position marker above/below mean sea level in metres. If no orthometric height is available the local ellipsoidal height will be exported.
M	Units of altitude as fixed text M
*hh	Checksum
<CR>	Carriage Return
<LF>	Line Feed

Examples

For NMEA v4.0:

Standard Talker ID = GPS only

\$GPLLQ,154324.00,111414,546629.232,M,5250781.577,M,
1,09,3.876,366.549,M*05

Standard Talker ID = GNSS

\$GNLLQ,154119.00,111414,546629.181,M,5250782.747,M,
1,20,3.890,367.393,M*1D

\$GPLLQ,154119.00,111414,,,,,09,,,*44

\$GLLLQ,154119.00,111414,,,,,07,,,*56

\$BDLLQ,154119.00,111414,,,,,04,,,*58

For NMEA v4.1:

Standard Talker ID = GPS only

\$GPLLQ,154324.00,111414,546629.232,M,5250781.577,M,
1,09,3.876,366.549,M*05

Standard Talker ID = GNSS

\$GNLLQ,154149.00,111414,546629.191,M,5250782.727,M,
1,20,3.880,367.387,M*1B



When more than one GNSS is active only \$GNLLQ is output.

E.13

RMC - Recommended Minimum Specific GNSS Data

Syntax

\$--RMC,hhmmss.ss,A,IIII.II,a,yyyyy.yy,a,x.x,x.x,xxxxx,x.x,a,*hh< CR >< LF >

Description of fields

Field	Description
\$--RMC	Header including talker ID
hhmmss.ss	UTC time of position fix
A	Status A = Data valid V = Navigation instrument warning
IIII.II	Latitude (WGS 1984)
a	Hemisphere, North or South
yyyyy.yy	Longitude (WGS 1984)
a	East or West
x.x	Speed over ground in knots
x.x	Course over ground in degrees
xxxxxx	Date: ddmmyy
x.x	Magnetic variation in degrees
a	East or West
*hh	Mode Indicator A = Autonomous mode D = Differential mode N = Data not valid
< CR >	Carriage Return

Field	Description
<LF>	Line Feed

Examples

For NMEA v4.0 and v4.1:

Standard Talker ID = GPS only and GNSS

```
$GNRMC,154706.00,A,4724.5288205,N,00937.0842621,E,0.01,144.09,141114,0.00,E,A*10
```

E.14

VTG - Course Over Ground and Ground Speed

Syntax

```
$--VTG,x.x,T,x.x,M,x.x,N,x.x,K,a*hh<CR><LF>
```

Description of fields

Field	Description
\$--VTG	Header including talker ID
x.x	Course over ground in degrees true north, 0.0 to 359.9
T	Fixed text T for true north
x.x	Course over ground in degrees magnetic North, 0.0 to 359.9
M	Fixed text M for magnetic North
x.x	Speed over ground in knots
N	Fixed text N for knots
x.x	Speed over ground in km/h
K	Fixed text K for km/h
a	Mode Indicator A = Autonomous mode D = Differential mode N = Data not valid
*hh	Checksum
<CR>	Carriage Return
<LF>	Line Feed



The Magnetic declination is set in the instrument in **Regional, Angle** page.

Examples

For NMEA v4.0 and v4.1:

Standard Talker ID = GPS only

```
$GPVTG,152.3924,T,152.3924,M,0.018,N,0.034,K,A*2D
```

Standard Talker ID = GNSS

```
$GNVTG,188.6002,T,188.6002,M,0.009,N,0.016,K,A*33
```

E.15

ZDA - Time and Date

Syntax

```
$--ZDA,hhmmss.ss,xx,xx,xxxx,xx,xx*hh<CR><LF>
```

Description of fields

Field	Description
\$-ZDA	Header including talker ID
hhmmss.ss	UTC time
xx	UTC day, 01 to 31
xx	UTC month, 01 to 12
xxxx	UTC year
xx	Local zone description in hours, 00 to ±13
xx	Local zone description in minutes, 00 to +59
*hh	Checksum
<CR>	Carriage Return
<LF>	Line Feed



This message is given high priority and is output as soon as it is created. Latency is therefore reduced to a minimum.

Examples

For NMEA v4.0 and v4.1:

Standard Talker ID = GPS only and GNSS

```
$GPZDA,155404.05,14,11,2014,01,00*61
```

AT commands

Hayes Microcomputer Products is a leading manufacturer of modems that has developed a language called the AT command set for controlling digital cellular phones and modems. This AT command set has become the de facto standard.

List of selected AT commands

The characters in this table are the most commonly used AT commands when configuring a digital cellular phone or modem. Refer to the manual of the used digital cellular phone or modem for information on which AT commands to use.

AT command	Description
~	Inserts a delay of 1/4 second.
^#	Inserts the phone number as defined in digital cellular phone connection.
^^	Inserts character ^.
^C	Bearer Service: Connection Element.
^M	Inserts a carriage return and send command.
^S	Bearer Service: Speed including Protocol and NetDataRate.
AT	Starts a command line to be sent to phone.
AT&F[<value>]	Sets the configuration parameters to default values specified by manufacturer of phone. <value>: <ul style="list-style-type: none"> 0 = Factory default configuration profile
ATD<number>	Starts a call to the phone number given as parameter. If ";" is present, a voice call to the given number is performed.
AT+CBST=[<speed> [,<name> [,<ce>]]]	Sets the bearer service <name> with data rate <speed>, and the connection element <ce>. Refer to the manual of the used digital cellular phone or modem for a list of supported name, speed and connection element values.
AT+CREG=[<mode>]	Enables/disables network registration reports depending on the parameter <mode>.
AT+CREG?	Reports the <mode> and registration status <stat> of phone. <mode>: <ul style="list-style-type: none"> 0 = Disable network registration unsolicited result code 1 = Enable network registration unsolicited result code <stat>: <ul style="list-style-type: none"> 0 = Not registered, ME is not currently searching a new operator to register to 1 = Registered, home network 2 = Not registered, but ME is currently searching a new operator to register to 3 = Registration denied 4 = Unknown 5 = Registered, roaming

AT command	Description
AT+COPS=[<mode>[,<format>[,<oper>],<AcT>]]]	<p>Forces an attempt to select and register the GSM\UMTS network operator.</p> <p><mode>:</p> <ul style="list-style-type: none"> • 0 = Automatic choice • 1 = Manual choice <p><format>:</p> <ul style="list-style-type: none"> • 0 = Alphanumeric long form • 1 = Short format alphanumeric • 2 = Numeric, 5 digits <p><oper>:</p> <ul style="list-style-type: none"> • Network operator in format defined by <format> <p><AcT>:</p> <p>Access technology selected:</p> <ul style="list-style-type: none"> • 0 = GSM • 2 = UTRAN
AT+COPS?	Returns the currently registered network operator.
AT+COPS=?	<p>Returns a list of all available network operators in form of: <stat>, long alphanumeric <oper>, short alphanumeric <oper>, numeric <oper>,<AcT>:</p> <p><stat>:</p> <p>Operator availability:</p> <ul style="list-style-type: none"> • 0 = Unknown • 1 = Available • 2 = Current • 3 = Forbidden <p><AcT>:</p> <p>Access technology selected:</p> <ul style="list-style-type: none"> • 0 = GSM • 1 = GSM Compact • 2 = UTRAN
AT+CPIN=<pin>[,<newpin>]	Sends the PIN to the phone.
AT+CPIN?	<p>Returns the status of the PIN request:</p> <ul style="list-style-type: none"> • READY = Phone can be used • SIM PIN = PIN is not set, phone not ready for use. • SIM PUK = PUK is required to use the device • ERROR = No SIM card inserted
AT+CSQ	Reports received signal quality indicators in form of: <signal strength><bit error rate>
AT+CSQ=?	Returns the supported ranges.
AT+FLO=<type>	<p>Selects the flow control behaviour of the serial port in both directions.</p> <ul style="list-style-type: none"> • 0 = Flow control None • 1 = Flow control Software (XON-XOFF) • 2 = Flow control Hardware (CTS-RTS)

Appendix G

Event Input Notify Message Format

Description

With GS25, a message can be created. This message provides information about

- the fact that an event was detected by the receiver
- the time when the event was detected.

The message can be in ASCII or in binary format. It is sent to a connected device, for example a PC.

Refer to "18.12 Event input 1/Event input 2" for configuring the event input interface.

Example

```
$PLEIR,HPT,134210000,1203*17
```

Syntax in ASCII

```
$PLEIR,EIX,sssssssss,ttttttt,nnnn,cccc,dddd*hh<CR><LF>
```

Description of the fields

Field	Description
\$PLEIR	Header
EIX	Message identifier. X = 1 for port E1 X = 2 for port E2
sssssssss	GPS time of week of event in ms
ttttttt	GPS time of week of event in ns
nnnn	GPS week number
cccc	Event count
dddd	Event pulse count This is the count of all pulses including those violating the specified accuracy limit boundary conditions set in Event Input 1/Event Input 2, Event input page. This allows determination of missed events.
*hh	Checksum
<CR>	Carriage return
<LF>	Line feed

Example

```
$PLEIR,EI2,292412000,28932,1203,203,1*70
```

Appendix H

PPS Output Notify Message Format

Description

With GS25, a message can be created. This message informs about the output of a PPS pulse. The message can be in ASCII or in binary format. It is sent to a connected device, for example a PC.

The message is sent at least 0.5 s before the next pulse. For this reason, notify messages are sent when the PPS output rate is greater than 1 s.

Refer to "18.11 PPS output" for configuring the PPS output interface.

Syntax in binary format

In binary, the notification message format is Leica Binary v2. Documentation for LB2 is available on request from the Leica Geosystems representative.

Syntax in ASCII

```
$PLEIR,HPT,sssssssss,nnnn*hh<CR><LF>
```

Description of the fields

Field	Description
\$PLEIR	Header
HPT	Message identifier, H igh P riority T ime
sssssssss	GPS time of week of next PPS output in ms
nnnn	GPS week number
*hh	Checksum
<CR>	Carriage return
<LF>	Line feed

Example

```
$PLEIR,HPT,134210000,1203*17
```

I.1

A

A (parameter)

For horizontal alignments:
 $A^2 = R * L$
 R = Radius of the connecting circular curve.
 L = Length of the spiral.

Arc

Refer to "Curve".

Attribute

Description

The use of attributes allows additional information to be stored with the code. Up to twenty attributes can be related to one code. Attributes are not compulsory.

Structure of attributes

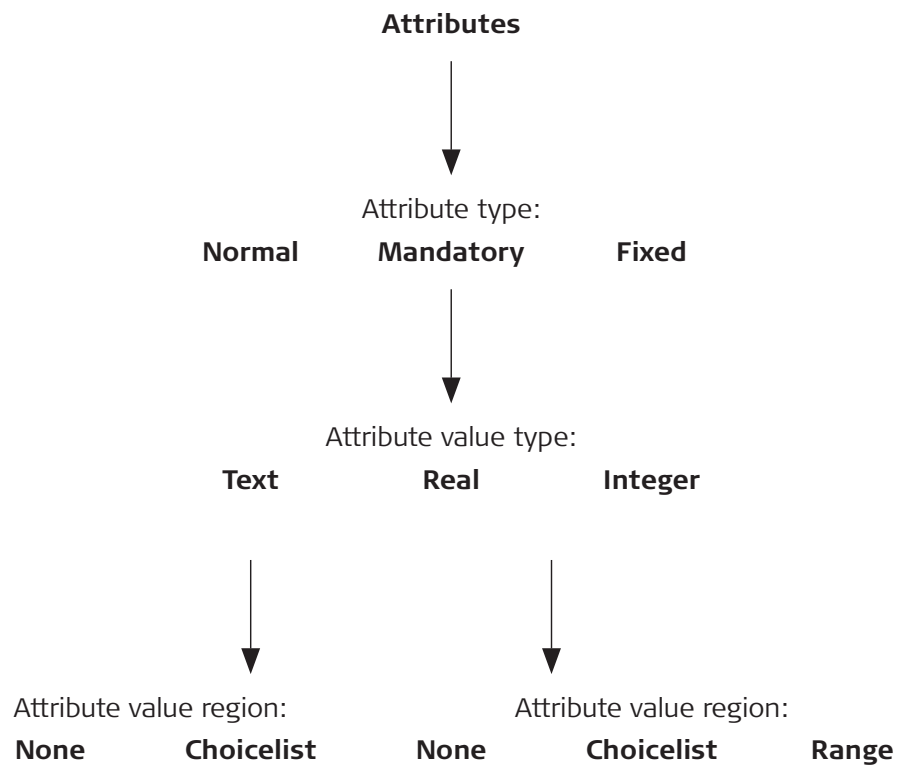

Example

Code	Attributes	Attribute value type	Attribute value region	Example for the attribute value region
Birch	Height	Real	Range	0.5-3.0
	Condition	Text	Selectable list	Good, Dead, Damaged
	Remark	Text	None	-

Attribute types

The attribute type defines the input requirements for the attribute.

Type	Description
Normal:	An input for the attribute is optional. The attribute value can be typed in the field. New attributes with this attribute type can be created in Infinity or on the instrument.
Mandatory:	An input for the attribute is compulsory. The attribute value must be typed in the field. New attributes with this attribute type can be created in Infinity.
Fixed:	The attribute value is a predefined default which is displayed but cannot be changed in the field. This attribute value is automatically attached to the code. New attributes with this attribute type can be created in Infinity.

Attribute value regions

The attribute value region defines if the attribute values must be selected from a predefined list.

Type	Description
None:	An input for the attribute must be typed in. New attributes with this attribute value region can be created in Infinity or on the instrument.
Range:	An input for the attribute must fall within a predefined range. New attributes with this attribute value region can be created in Infinity.
Selectable list:	An input for the attribute is selected from a predefined list. New attributes with this attribute value region can be created in Infinity.

Attribute value types

The attribute value type defines which values are accepted as input.

Type	Description
Text:	Any input for the attribute is interpreted as text. New attributes with this attribute value type can be created in Infinity or on the instrument.
Real:	An input for the attribute must be a real number, for example 1.23. New attributes with this attribute value type can be created in Infinity.
Integer:	An input for the attribute must be an integer number, for example 5. New attributes with this attribute value type can be created in Infinity.

Averaging

Use the **Duplicate points** mode. The mode defines the checks which are performed when more than one set of measured coordinates are recorded for the same point. The settings affect the behaviour of the instrument when editing a point and calculating averages.

I.2

B

I.3

C

Chainage equation

Chainage equations define adjustments for the chainage values in the horizontal alignment. These adjustments can be necessary when a horizontal align-

ment is modified, by inserting or removing an element, and the chainage values in the horizontal alignment are not recomputed. This situation can occur when editing manually or editing with a program that does not automatically recompute. Chainage equations define leaving a gap or allowing an overlap at certain chainages.

The elements involved in the equations are:

- chainage back
- chainage ahead.

Class

The class describes the type of coordinate triplet.

Description of classes

The following table shows the classes in descending hierarchical order.

Class	Characteristic	Description
Control	Type	Control points. Automatically assigned to entered points or manually assigned to calculated points from COGO.
	Instrument source	GS, TS or Infinity
	Number of triplets	One
Adjusted	Type	Adjusted points using the adjustment program.
	Instrument source	Infinity or Leica Captivate (Measure foresight)
	Number of triplets	One
Reference	Type	<ul style="list-style-type: none"> • Reference point received by a real-time rover • Point set by Setup app.
	Instrument source	GS, TS or Infinity
	Number of triplets	One
Average	Type	Averaged point calculated when more than one coordinate triplet of class Measured exist for the same point ID unless When a point is stored with same point ID as existing point: Don't check in the Duplicate Points panel.
	Instrument source	GPS or TS
	Number of triplets	One
Measured	Type	<ul style="list-style-type: none"> • Measured points differentially corrected using real-time phase, real-time code or post-processing. • Measured points with angles and distances.

Class	Characteristic	Description
	Instrument source	<ul style="list-style-type: none"> Calculated from some apps. GS, TS or Infinity
	Number of triplets	Multiple. With more than one measured coordinate triplet, the average for the position and the height can be computed.
Navigated	Type	Navigated points using uncorrected code solutions of a single epoch or SPP positions.
	Instrument source	GS
	Number of triplets	Multiple
Estimated	Type	Estimated points from Infinity.
	Instrument source	Infinity or Leica Captivate (Create point here)
	Possible number of triplets	One
None	Type	Measured points with angles.
	Instrument source	TS
	Possible number of triplets	Unlimited

Code

Description

A code is a description which can be stored with an object or alone.

Code group

A code group allows codes belonging to the same theme to be grouped. Individual groups can be activated or deactivated. The codes belonging to a deactivated code group cannot be selected from the selectable list for code selection.

Code types

The code type defines how and for which objects a code can be used.

Type	Description
Point code	Object related information recorded together with the current point in the field.
Free code	Time-related information recorded between points in the field. A time stamp is recorded with each free code. The time stamp defines the chronological order in the export of free codes and points for use in third-party mapping software.
Quick code	Quick coding is the storing of an object plus a point or free code using a minimum number of keystrokes.

Coordinate system - elements

The five elements which define a coordinate system are:

- a transformation
- a projection
- an ellipsoid
- a geoid model
- a **C**ountry **S**pecific **C**oordinate **S**ystem model

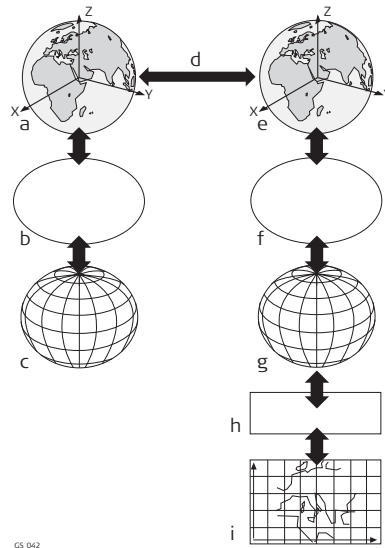

- a WGS 1984 cartesian: X, Y, Z
- b WGS 1984 ellipsoid
- c WGS 1984 geodetic: Latitude, longitude, ellipsoidal height
- d 7 parameter transformation: dX, dY, dZ, rx, ry, rz, scale
- e Local cartesian: X, Y, Z
- f Local ellipsoid
- g Local geodetic: Latitude, longitude, ellipsoidal height
- h Local projection
- i Local grid: Easting, Northing, orthometric height

All these elements can be specified when creating a coordinate system.

Coordinate triplet

A measured point consists of three coordinate components - two horizontal components and one vertical component. The generic term for the three coordinate components is coordinate triplet.

Depending on the class, a point ID can contain more than one coordinate triplet of the same and/or of different classes.

CSCS field file

CSCS field files can be used in the field to convert coordinates directly from WGS 1984 to local grid without the need of transformation parameters.

Type	Description
Creation	In Infinity with export onto a data storage device or the internal memory of the instrument.
Extension	*.csc

CSCS model

Description

Country Specific Coordinate System models

- are tables of correction values to convert coordinates directly from WGS 1984 to local grid without the need of transformation parameters.
- take the distortions of the mapping system into account.
- are an addition to an already defined coordinate system.

Types of CSCS models

The correction values of a CSCS model can be applied at different stages in the coordinate conversion process. Depending on this stage, a CSCS model works differently. Three types of CSCS models are supported. Their conversion process is as explained in the following table. Any suitable geoid model can be combined with a geodetic CSCS model.

Type	Description
Grid	1 Determination of preliminary grid coordinates by applying the specified transformation, ellipsoid and map projection.
	2 Determination of the final local grid coordinates by applying a shift in Easting and Northing interpolated in the grid file of the CSCS model.
Cartesian	1 Performing the specified transformation.
	2 Determination of local cartesian coordinates by applying a 3D shift interpolated in the grid file of the CSCS model.
	3 Determination of the final local grid coordinates by applying the specified local ellipsoid and map projection.
Geodetic	1 Determination of local geodetic coordinates by applying a correction in latitude and longitude interpolated from the file of the CSCS model.
	2 Determination of the final local grid coordinates by applying the local map projection.
	 Using a geodetic CSCS model excludes the use of a transformation in a coordinate system.

Coordinate quality for GS

Description

The **Coordinate Quality** is

- computed on the rover for code solutions and phase fixed solutions.
- an indicator for the quality of the observations.
- an indicator for the current satellite constellation.
- an indicator for different environmental conditions.
- derived such that there is at least a two third probability that the computed position deviates from the true position by less than the CQ value.
- different from the standard deviation.

CQ versus standard deviation

The standard deviation as CQ would often be too optimistic, therefore the computation of the CQ is not based on the basic standard deviation algorithms. There is a 39.3% statistical probability in 2D, that the computed position deviates

ates from the true position, by less than the standard deviation. This probability is not enough for a reliable quality indicator.

This unreliability is true for low redundancy situations such as a constellation of four satellites. In such a case, the RMS converges to zero and the standard deviation would show an unrealistically small value.

Computation

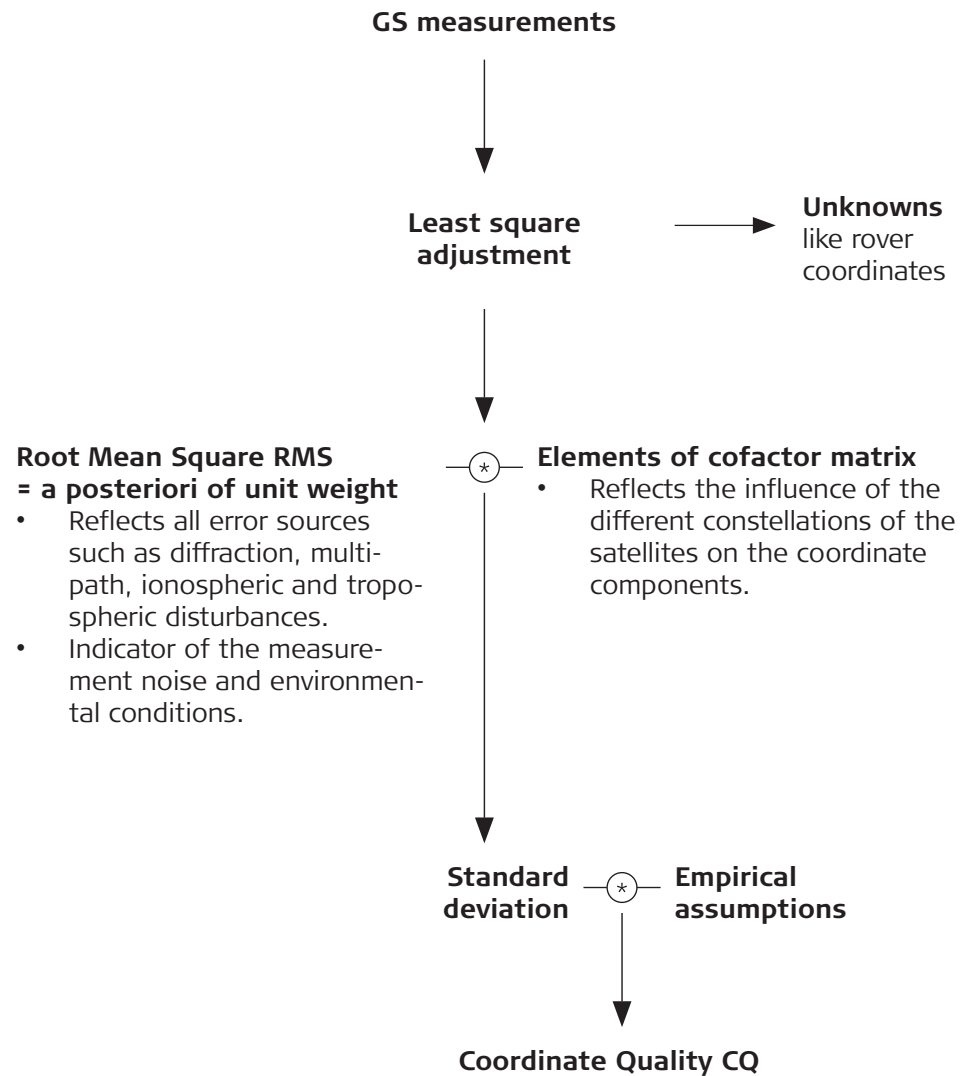

Range

For a phase fixed solution	Centimetre level
For a code solution	From 0.4 m to 5 m.

Position CQ versus height CQ

All GS computed positions are almost twice as accurate in plan than in height. For the position determination, satellites can appear in all four quadrants. For the height determination, satellites can appear in two quadrants. Fewer quadrants weaken the height position compared to the plan position.

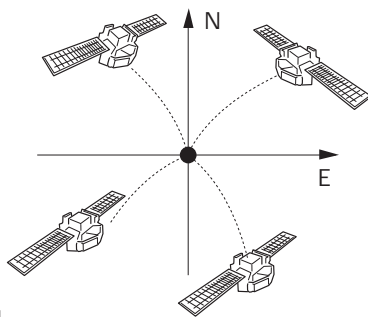

GS12_041

Position determination with satellites appearing in all four quadrants.

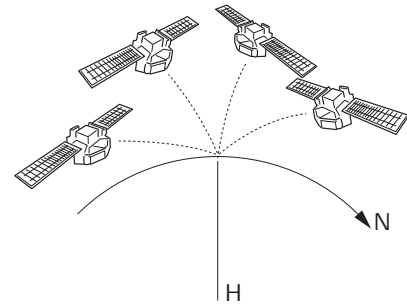

Height determination with satellites appearing in two quadrants.

Coordinate quality for TS

Description

The **Coordinate Quality** is an indicator for the estimated quality of the point coordinates. The coordinate quality of the measurements is used in point averaging.

Type	Description
Est 3D CQ	Estimated 3D coordinate quality of computed position.
Est 2D CQ	Estimated plan coordinate quality of computed position.
Est 1D CQ	Estimated height coordinate quality of computed position.

Vertical angles are always assuming zenith angles and not elevation angles. Standard deviations of circle readings relate to one face measurements.

$$\rho = \frac{200}{\pi}$$

Standard deviation of circle reading

$$\sigma_{Hz, V} [\text{rad}] = \frac{\sigma_{Hz, V} [\text{gon}]}{\rho}$$

$\sigma_{Hz, V}$ Standard deviation of circle reading if $\sigma_{Hz} = \sigma_V$.
 σ_{Hz} : Standard deviation of horizontal circle reading.
 σ_V : Standard deviation of vertical circle reading.

Standard deviation of distance measurement

$$\sigma_D = c_D + \text{ppm} * D$$

σ_D Standard deviation of distance measurement.
 c_D Constant part of EDM accuracy.
 ppm ppm part of EDM accuracy.
 D Slope Distance.

1D estimated coordinate quality

$$1D \text{ CQ} = \sqrt{\sigma_D^2 * \cos^2 V + \sigma_{Hz, V}^2 * D^2 * \sin^2 V}$$

1D CQ Estimated coordinate quality of the height.
 V Zenith angle.

2D estimated coordinate quality

$$2D \text{ CQ} = \sqrt{\sigma_D^2 * \sin^2 V + \sigma_{Hz, V}^2 * D^2}$$

2D CQ Estimated horizontal coordinate quality.

3D estimated coordinate quality

$$3D \text{ CQ} = \sqrt{\sigma_D^2 + \sigma_{Hz, V}^2 * D^2 * (1 + \sin^2 V)}$$

3D CQ Estimated spatial coordinate quality.

Working Example 1

Instrument:	TS15
Angular accuracy:	2" = 6.1728*10 ⁻⁴ gon => $\sigma_{Hz, V} = 2" * \sqrt{2}$
EDM accuracy:	1 mm + 1.5 ppm for an IR measurement
Slope distance:	150 m
Hz:	210 gon
V:	83 gon

$$1D \text{ CQ} = 0.00201 \text{ m} \cong 2.0 \text{ mm}$$

$$2D \text{ CQ} = 0.00237 \text{ m} \cong 2.4 \text{ mm}$$

$$3D \text{ CQ} = 0.00311 \text{ m} \cong 3.1 \text{ mm}$$

Working Example 2

Instrument:	TS15
Angular accuracy:	2" = 6.1728*10 ⁻⁴ gon => $\sigma_{Hz, V} = 2" * \sqrt{2}$
EDM accuracy:	1 mm + 1.5 ppm for an IR measurement
Slope distance:	7000 m
Hz:	210 gon
V:	83 gon

$$1D \text{ CQ} = 0.09263 \text{ m} \cong 92.6 \text{ mm}$$

$$2D \text{ CQ} = 0.09663 \text{ m} \cong 96.6 \text{ mm}$$

$$3D \text{ CQ} = 0.13386 \text{ m} \cong 133.9 \text{ mm}$$

Working Example 3

Instrument:	TM50
-------------	------

Angular accuracy:	$0.5'' = 1.5432 \times 10^{-4} \text{ gon} \Rightarrow \sigma_{Hz,V} = 0.5'' \cdot \sqrt{2}$
EDM accuracy:	1 mm + 1 ppm for standard mode
Slope distance:	150 m
Hz:	210 gon
V:	83 gon

1D CQ = 0.00058 m \cong 0.6 mm

2D CQ = 0.00122 m \cong 1.2 mm

3D CQ = 0.00135 m \cong 1.3 mm

Working Example 4

Instrument:	TM50
Angular accuracy:	$0.5'' = 1.5432 \times 10^{-4} \text{ gon} \Rightarrow \sigma_{Hz,V} = 0.5'' \cdot \sqrt{2}$
EDM accuracy:	1 mm + 1 ppm for standard mode
Slope distance:	7000 m
Hz:	210 gon
V:	83 gon

1D CQ = 0.02324 m \cong 23.2 mm

2D CQ = 0.02521 m \cong 25.3 mm

3D CQ = 0.03429 m \cong 34.3 mm

Cross section assignments

One cross section is valid until a new one is defined at a chainage ahead. Cross section definition can be at any chainage. The chainages need not necessarily correspond to chainages where a design element starts or ends.

Cross section template

A Cross section gives a profile view. It requires vertical alignment or actual elevation on each chainage.

The elements involved are straight elements. The points are called vertices. You can optionally define slopes at the vertices most left and most right.

Points are defined by:

- DH and DV
- DH and slope in percentage
- DH and slope in ratio

Curve

For horizontal alignments: Circular curve with constant radius.

For vertical alignments: Circular vertical curve with constant radius.

1.4

D

Device

The hardware which is connected to the chosen port.

For GS: Devices are used to transmit and receive real-time data and to communicate with the instrument, for example to download raw observations from a remote location.

For TS: Devices are used to transmit and receive measurement data.

I.5

E

I.6

F

I.7

G

Geoid model

Description

GNSS operates on the WGS 1984 ellipsoid and all heights obtained by measuring baselines are ellipsoidal heights. Existing heights are orthometric heights, also called height above the geoid, height above mean sea-level or levelled height. The mean sea level corresponds to a surface known as the geoid. The relation between ellipsoidal height and orthometric height is

Orthometric Height = Ellipsoidal Height - Geoid Separation N

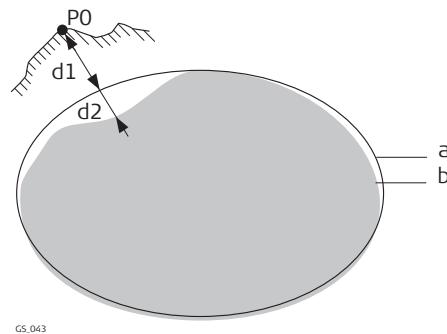

- a WGS 1984 ellipsoid
- b Geoid
- P0 Measured point
- d1 Ellipsoidal height
- d2 Geoid separation N, is negative when the geoid is below the ellipsoid

N value and geoid model

The geoid separation (N value) is the distance between the geoid and the reference ellipsoid. It can refer to the WGS 1984 or to the local ellipsoid. It is not a constant except over maybe small flat areas such as 5 km x 5 km. Therefore it is necessary to model the N value to obtain accurate orthometric heights. The modelled N values form a geoid model for an area. With a geoid model attached to a coordinate system, N values for the measured points can be determined. Ellipsoidal heights can be converted to orthometric heights and back.

Geoid models are an approximation of the N value. In terms of accuracy, they can vary considerably and global models in particular should be used with caution. If the accuracy of the geoid model is not known, it can be safer to use local control points with orthometric heights and apply a transformation to approximate the local geoid.

Geoid field file

The geoid separations in a geoid field file can be used in the field to change between ellipsoidal and orthometric heights.

Type	Description
Creation	In Infinity with export onto a data storage device or the internal memory of the instrument.
Extension	*.gem

GNSS points

The coordinates of GNSS points are always stored in the WGS 1984 coordinates system. WGS 1984 is a three-dimensional Cartesian coordinate system with the origin at the centre of the Earth. WGS 1984 coordinates are given as X,Y,Z Cartesian coordinates, or latitude, longitude and height (above the WGS 1984 ellipsoid).

GNSS points are stored as class **Measured** or class **Navigated**:

- Class Measured: If there are 5 or more satellites, and the distance to the reference is not too great for the prevailing ionospheric conditions, SmartStation computes a GNSS real-time position. The CQ indicator for this type of point is about 0.01 m to 0.05 m.
- Class Navigated: If the reference stops working, or if the communication link between the reference and SmartStation fails, SmartStation computes a navigation position. The CQ indicator for this type of point is about 3 m to 20 m.

GNSS surveying techniques

Depending on the surveying task and the instruments being used, certain GNSS surveying techniques are possible. The three existing types of GNSS surveying techniques are:

GNSS surveying technique	Characteristic	Description
Static	Way of working	<ul style="list-style-type: none">• Base set up over a point with accurately known coordinates.• Rover set up over a point with known or unknown coordinates.• Data recorded at both instruments simultaneously at the same data rate, typically 15 s, 30 s or 60 s.• Post-processing is compulsory.
	Use	For long baselines, geodetic networks, tectonic plate studies.
	Accuracy	High over long baselines.
	Working speed	Slow
Post-processed kinematic	Way of working	<ul style="list-style-type: none">• Base set up as static over a point with accurately known coordinates.• Rover moves from one point to another. The instrument remains turned on while moving.• Static and moving raw observations are collected.• Post-processing is compulsory.
	Use	For detail surveys and measuring many points in quick succession.
	Accuracy	High for baselines up to 30 km.
	Working speed	Efficient for surveying many points that are close together.
Real-time, base and rover	Way of working	<ul style="list-style-type: none">• Base set up as static over a point with accurately known coordinates in WGS 1984.

GNSS surveying technique	Characteristic	Description
		<ul style="list-style-type: none"> • Rover equipment is set up on a pole and moves from one unknown point to another. • A data link, for example a radio or digital cellular phone, transmits satellite data from the base to the rover. • Data coming from the base and GNSS signals received on the rover are processed together on the rover as the survey is carried out in real time. • Ambiguities are solved, coordinates of the surveyed points are calculated and displayed. • apps as on conventional instruments like stakeout or COGO can be performed. • Post-processing is optional.
	Use	For surveying detail with many points in one area.
	Accuracy	High for baselines up to 30 km.
	Working speed	Efficient as the results are generated in the field.

Refer to standard surveying literature for more details on GNSS surveying techniques.

I.8

Horizontal Alignment

H

The horizontal alignment defines the road axis of a project. Horizontal alignments are comprised of the elements:

- straights (tangents)
- curves (arcs)
- spirals (clothoid or cubic parabola)
- blossom curves (element type used for railway track design)

Each element involved is defined by individual horizontal design elements such as chainage, Easting, Northing, radius and parameter A.

I.9

Initialisation

I

For cm positioning with GNSS, the ambiguities must be fixed. The process of fixing ambiguities is called initialisation. In order to carry out an initialisation, the real-time rover settings must allow for phase fixed solutions. A minimum of five satellites on L1 and L2 is required.

The rover instrument is moved from the beginning of the GNSS operation on, recording data. The trajectory of the moving rover is recorded. Ambiguities are

fixed while moving. A new initialisation starts automatically when, after losing the minimum number of required satellites, enough satellites are tracked again.

Instrument source

The instrument source describes where the coordinate triplet was measured or entered. The options are GS, TS, Infinity or Level.

Interface

The procedures, codes and protocols that enable two entities to interact for an exchange of data. Each interface is given a meaningful display name which enables easy distinction between interfaces.

I.10

J

I.11

K

I.12

L

I.13

M

I.14

N

Ntrip

Networked Transport of RTCM using Internet Protocol

- is a protocol streaming real-time corrections over the Internet.
- is a generic protocol based on the Hypertext Transfer Protocol HTTP/1.1.
- is used to send differential correction data or other kinds of streaming data to stationary or mobile users over the Internet. This process allows simultaneous computer, laptop, PDA, or instrument connections to a broadcasting host.
- supports wireless Internet access through mobile IP networks like digital cellular phones or modems.

The Ntrip Server could be the GS itself. This setup means the GS is both the Ntrip Source generating the real-time data and also the NTRIP Server transferring this data to the Ntrip Caster.

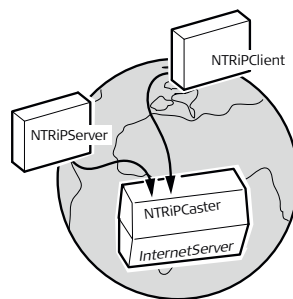

GS.044

Ntrip and its role in the Internet

Ntrip Caster

The Ntrip Caster

- is an Internet server handling various data streams to and from the Ntrip Servers and Ntrip Clients.
 - checks the requests from Ntrip Clients and Ntrip Servers to see if they are registered to receive or provide real-time corrections.
 - decides whether there is streaming data to be sent or to be received.
-

Ntrip Client

The Ntrip Client receives data streams. This setup could be, for example a real-time rover receiving real-time corrections.

In order to receive real-time corrections, the Ntrip Client must first send

- a user ID
- a password
- an identification name, the so-called Mountpoint, from which real-time corrections are to be received

to the Ntrip Caster.

Ntrip Server

The Ntrip Server transfers data streams.

In order to send real-time corrections, the Ntrip Server must first send

- a password
- an identification name, the so-called Mountpoint, where the real-time corrections come from

to the Ntrip Caster.

Before sending real-time corrections to the Ntrip Caster for the first time, a registration form must be completed. This form is available from the Ntrip Caster administration centre. Refer to the website of the Ntrip Caster administration centre.

Ntrip Source

The Ntrip Source generates data streams. This setup could be base sending out real-time corrections.

Ntrip system components

Ntrip consists of three system components:

- Ntrip Clients
- Ntrip Servers
- Ntrip Caster

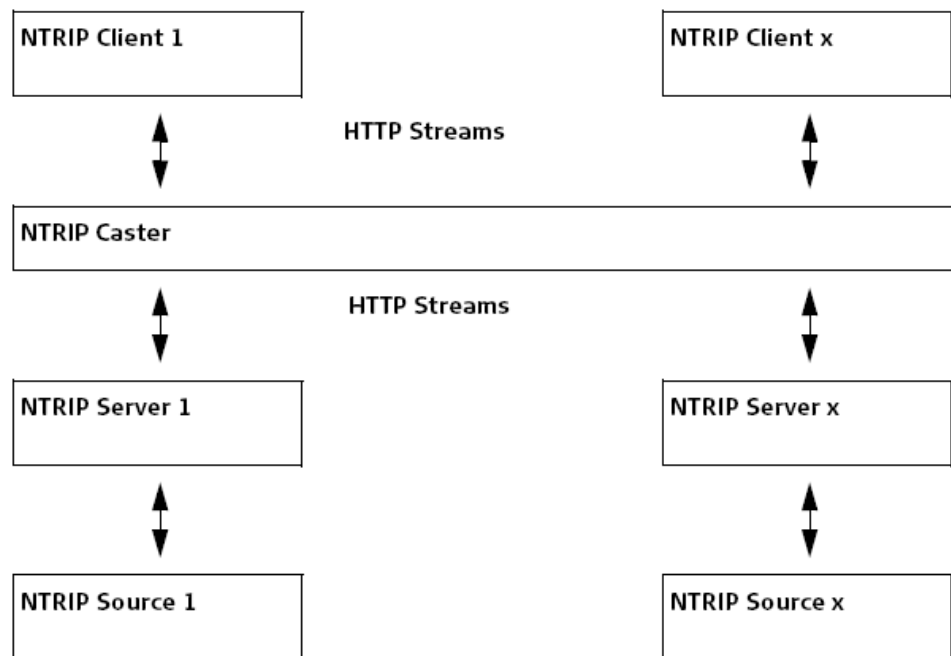

I.15

O

I.16

P

Parabola

Parabolic vertical curve with constant rate of grade change.

An asymmetrical parabola uses inconstant rates of change.

Parameter A

Refer to "A (parameter)".

Port

A connection through which a separate device can communicate with the instrument.

I.17

Q

I.18

R

I.19

S

Source

The source describes the app or functionality that generated a coordinate triplet and the method with which it was created.

Source	Originated from app/functionality	Instrument source
ASCII file	Import data, ASCII	GS or TS
Arc base pt	Line & arc calculation, base point	GS or TS
Arc centre point	Line & arc calculation, centre point	GS or TS
Arc offset pt	Line & arc calculation, offset point	GS or TS
Arc segment pt	Line & arc calculation, segmentation	GS or TS
Backward brg-dst	Measure hidden point, Back bearing & distance	GS
Bearing-Distance	Measure hidden point, Bearing & distance	GS
Distance & offset	Measure hidden point, Distance & offset	GS
COGO Area Div	Area division	GS or TS
COGO Shift/Rtn	Shift, rotate & scale	GS or TS
COGO Brng & distance	Bearing & distance	GS or TS
Using 2 bearings	Measure hidden point, Using 2 bearings	GS
Using 2 distances	Measure hidden point, Using 2 distances	GS
GSI file	Import data, GSI	GS or TS
TPS Hidden Point	Measure hidden point, auxiliary points	TS
Intsct (Brg Brg)	Intersection, Bearing & bearing	GS or TS
Intsct (Brg Dst)	Intersection, Bearing & distance	GS or TS
Intsct (Dst Dst)	Intersection, Distance & distance	GS or TS
Intsct (4 Pts)	Intersection, Four points	GS or TS
LandXML	Design to Field in Infinity converting data from LandXML software to be used in the field	Infinity
Line Base Pt	Line & arc calculation, base point	GS or TS

Source	Originated from app/functionality	Instrument source
Line Offset Pt	Line & arc calculation, offset point	GS or TS
Line Segmt Pt	Line & arc calculation, segmentation	GS or TS
None	No information on the source is available	GS or TS
RefLine (Grid)	Stake to line, staked out in a defined grid	GS or TS
RefLine (Meas)	Measure to line, measured	GS or TS
RefLine (Seg)	Measure to line/Stake to line, segmented	GS or TS
RefLine (Stake)	Stake to line	GS or TS
Ref Plane (Meas)	Meas plane/grid, measured	GS or TS
Ref Plane (Scan)	Meas plane/grid, scan	TS
Road	Roads	GS or TS
Sets of angles	Measure sets	TS
Setup (known backsight)	Setup, Known backsight	TS
Setup (Ori&Ht)	Setup, Transfer height	TS
Setup (resection)	Setup, Resection	TS
Setup (set orientation)	Setup, Set orientation	TS
Srvy Auto Offset	Measure, auto points, automatically recorded with offsets	GS or TS
Stakeout	Stake to line	GS or TS
Measure	Measure, measured	TS
Measure (Auto)	Measure, auto points, automatically recorded	TS
Measure (Event)	Measure, event input	GS
Measure (Instant)	Measure	GS
Measure (Rem Pt)	Measure, remote point	TS
Measure (Static)	Measure	GS
Traverse	Bearing & distance	TS
Unknown	-	GS or TS
User App	Customised apps	GS or TS
User entered	Manually entered point	GS or TS

Spiral

For horizontal alignments:

Spirals are used to connect straights and curves. A full spiral has an infinite radius at its start or end point whereas a partial has a finite radius at its start and end point.

In. Radius at the start point is bigger than at the end point.

Out. Radius at the start point is smaller than at the end point.

Straight

Straight line between two points. Its end point is identical with the beginning of a curve or spiral. The tangent is perpendicular to the radius of the curve.

Sub class

The sub class describes certain classes in detail. It indicates the status of the position when a coordinate triplet was measured and how the coordinates were determined.

Sub class	Description	Instrument source
COGO	Indirect coordinate determination with app COGO.	GPS or TS
None	Direction is available but no coordinates.	TS
	Height is available but no position coordinates.	Level
TS	Measured with distances and angles.	TS
Fixed (Height)	Manually entered and fixed in height.	GPS or TS
Fixed (Position)	Manually entered and fixed in position.	GPS or TS
Fixed (Pos & Ht)	Manually entered and fixed in position and height.	GPS or TS
GNSS code only	Direct coordinate determination with code solution.	GPS
GNSS fixed	Direct coordinate determination with phase fixed solution.	GPS
GNSS float	Direct coordinate determination using GNSS or with autonomous solution coming from Infinity.	GPS
GPS Hidden Point	Indirect coordinate determination with hidden point measurements.	GPS or TS

I.20

T

Tangent

Refer to straight.

TS mode

Current active instrument is TS.

Transformations

A transformation is the process of converting coordinates from one geodetic datum to another.

Requirements

- Transformation parameters.
- In some cases a local ellipsoid.
- In some cases a map projection.
- In some cases a geoid model.

Transformation parameters

A transformation consists of shifts, rotations and scale factors, depending on the type of transformation used. Not all these parameters are always required. These parameters can already be known, or can be computed.

Description of transformations

- Classic 3D, also called Helmert transformation
- Onestep
- Twostep

Transformation	Characteristic	Description
Classic 3D	Principle	Transforms coordinates from WGS 1984 cartesian to local cartesian coordinates and vice versa. A map projection can then be applied to obtain grid coordinates. As a similarity transformation, it is the most rigorous transformation type and keeps the full geometrical information.
	Positions and heights	Positions and heights are linked. The accuracy is fully maintained and does not distort the measurements.
	Use	When measurements are to be kept homogenous.
	Requirements	<ul style="list-style-type: none">• The positions and heights are known in WGS 1984 and in the local system for at least three points. Four points or more are recommended to obtain higher redundancy.• Parameters of the local ellipsoid.• Parameters of the local map projection, to convert between grid coordinates and geodetic coordinates.• Parameters of the local geoid model, to convert between orthometric and ellipsoidal heights. This information is not compulsory.
	Area	Especially wide networks with large height differences. Local grid coordinates must be accurate.
	Advantage	<ul style="list-style-type: none">• Accuracy of the measurements is maintained.• It can be used over any area as long as the local coordinates, including heights, are accurate.

Transformation	Characteristic	Description
	Disadvantage	<ul style="list-style-type: none"> The local ellipsoid and map projection must be known for the local grid coordinates. In order to obtain accurate ellipsoidal heights, the geoid separation at the measured points must be known. This information can be determined from a geoid model.
Onestep	Principle	<p>Transforms coordinates directly from WGS 1984 to local grid and vice versa without knowledge about the local ellipsoid or the map projection. Procedure:</p> <ol style="list-style-type: none"> The WGS 1984 coordinates are projected onto a temporary Transverse Mercator Projection. The central meridian of this projection passes through the centre of gravity of the common control points. The results of 1. are preliminary grid coordinates for the WGS 1984 points. These preliminary grid coordinates are matched with the local grid control points. The Easting and Northing shifts, the rotation and scale factor between these two sets of points can then be computed. This process is known as a classic 2D transformation. The height transformation is a single dimension height approximation.
	Positions and heights	The position and height transformations are separated.
	Use	<p>When measurements are to be forced to tie in with local existing control. For example:</p> <p>A site where the coordinates of the control points are based on a purely local grid. The coordinate values within this grid are arbitrary and are in no way connected with any ellipsoid or map projection. Obviously a Classic 3D transformation cannot be used here, as cartesian coordinates cannot be calculated from such a grid.</p>

Transformation	Characteristic	Description
	Requirements	<ul style="list-style-type: none"> • The position is known in WGS 1984 and in the local system for at least one point. Three or more points are recommended to obtain redundancy. • Additional height information for one point enables the transformation of heights. • Parameters of the local geoid model. This information is not compulsory. • No parameters of the local ellipsoid. • No parameters of the local map projection.
	Area	<ul style="list-style-type: none"> • Limited to about 10 x 10 km as no projection scale factor is applied and a standard Transverse Mercator Projection is used to compute the preliminary WGS 1984 grid coordinates. • For areas without large height differences.
	Points and transformation parameters	<p>The transformation parameters determined depend on the number of available points with position information.</p> <ul style="list-style-type: none"> • One point: Classic 2D with shift in X and Y. • Two points: Classic 2D with shift in X and Y, rotation about Z and scale. • More than two points: Classic 2D with shift in X and Y, rotation about Z, scale and residuals.
	Points and height transformation	<p>The type of height transformation performed depends on the number of available points with height information.</p> <ul style="list-style-type: none"> • No point: No height transformation. • One point: Heights are shifted to fit to the height control point. • Two points: Average height shift between the two height control points.

Transformation	Characteristic	Description
	Advantage	<ul style="list-style-type: none"> • Three points: Tilted plane through the three height control points to approximate the local heights. • More than three points: Best fitting average plane. • Errors in height do not propagate into errors in position since the height and position transformations are separated. • If local heights have low accuracy or do not exist, a transformation of position can still be calculated and vice versa. • The height points and position points do not have to be the same points. • No parameters of the local ellipsoid and map projection is required. • Parameters can be computed with a minimum of points. Care must be taken when computing parameters using just one or two local points, as the parameters calculated are valid in the vicinity of the points used for the transformation.
	Disadvantage	<ul style="list-style-type: none"> • Restriction in the area over which the transformation can be applied. This restriction is because there is no provision for scale factor in the projection. • The accuracy in height depends on the undulation of the geoid. The bigger the geoid variations the less accurate the results are.
Twostep	Principle	Combines the advantages of the Onestep and the Classic 3D transformation. It allows treating position and height separately, but is not restricted to smaller areas. Procedure:

Transformation	Characteristic	Description
		<ol style="list-style-type: none"> 1. The WGS 1984 coordinates of the common control points are shifted closely to the local datum using a given Classic 3D pre-transformation. This Classic 3D pre-transformation is typically a rough transformation valid for the country of the local datum. 2. The coordinates are projected onto a preliminary grid, but this time using the true map projection of the local points. 3. A 2D transformation is applied, exactly as with the Onestep transformation.
	Positions and heights	The position and height transformations are separated.
	Use	When measurements are to be forced to tie in with local existing control in areas larger than 10 x 10 km.
	Requirements	<ul style="list-style-type: none"> • The position is known in WGS 1984 and in the local system for at least one point. Four points or more are recommended to obtain higher redundancy. • Parameters of the local ellipsoid. • Parameters of the local map projection. • Parameters of a pre-transformation.
	Area	Virtually any area as long as the local coordinates are accurate.
	Points and transformation parameters	Identical with the Onestep transformation.
	Points and height transformation	Identical with the Onestep transformation.
	Advantage	<ul style="list-style-type: none"> • Errors in height do not propagate into errors in position since the height and position transformations are separated. • If local heights have low accuracy or do not exist, a transformation of position can still be calculated and vice versa. • The height points and position points do not have to be the same points.

Transformation	Characteristic	Description
		<ul style="list-style-type: none"> Fits much better over larger areas than a Onestep transformation. Reason: <p>The first step of a Twostep transformation avoids any distortions because the preliminary grid coordinates are built on a different ellipsoid than the local points. The second step ensures that the influence of the map projection scale factor is taken into account before the final 2D transformation is computed.</p>
	Disadvantage	<ul style="list-style-type: none"> The local ellipsoid must be known. The map projection must be known. A pre-transformation must be known. A null transformation can be used. In order to obtain accurate ellipsoidal heights, the geoid separation at the measured points must be known. This information can be determined from a geoid model.

I.21

U

I.22

V

Vertical alignment

The vertical alignment gives information about the pattern of heights of the road axis as it is defined in the horizontal alignment.

A vertical alignment is comprised of the elements:

- tangents (straight segments)
- curves
- parabolas.

Each element involved is defined by individual vertical design elements such as chainage, Easting, Northing, radius and parameter P.

I.23

W

WGS 1984

WGS 1984 is the global geocentric datum to which all GNSS positioning information is referred to.

I.24

X

I.25

Y

I.26

Z

832702-3.0.0en

Original text (832702-3.0.0en)

Published in Switzerland

© 2017 Leica Geosystems AG, Heerbrugg, Switzerland

Leica Geosystems AG

Heinrich-Wild-Strasse
CH-9435 Heerbrugg
Switzerland
Phone +41 71 727 31 31

www.leica-geosystems.com



- when it has to be **right**

Leica
Geosystems